

285/2010

406/2010

© Commonwealth of Australia 2010

AUS 809

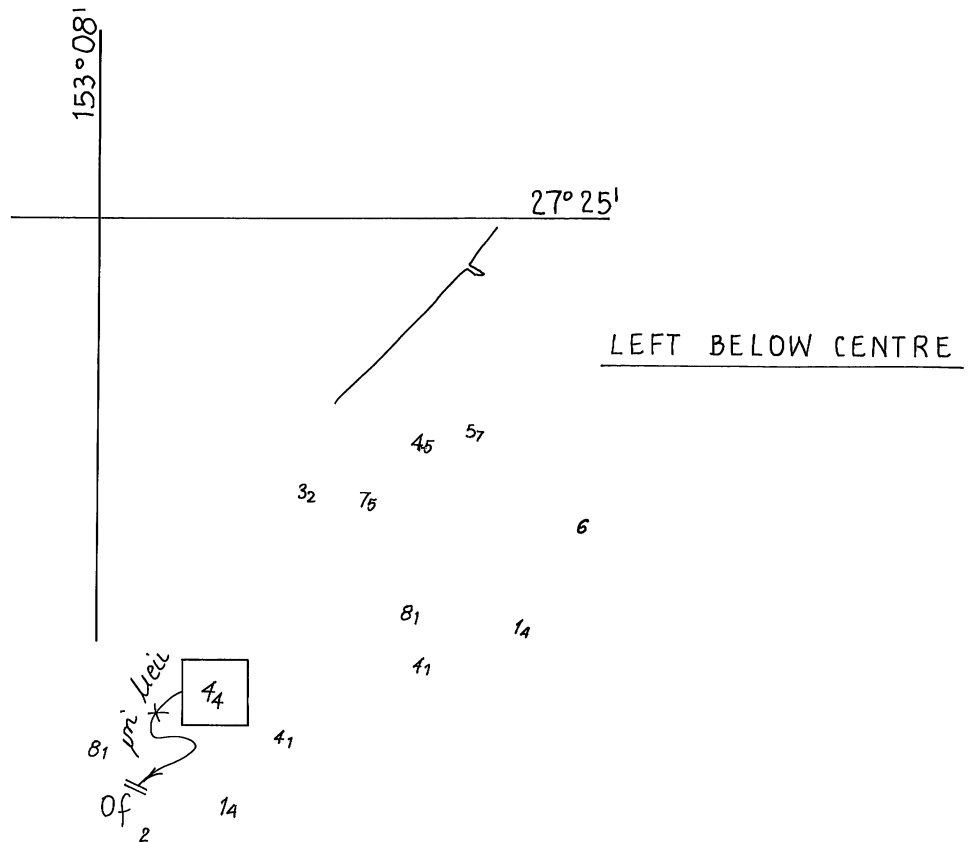

30/2010

407/2010

© Commonwealth of Australia 2010

AUS 237

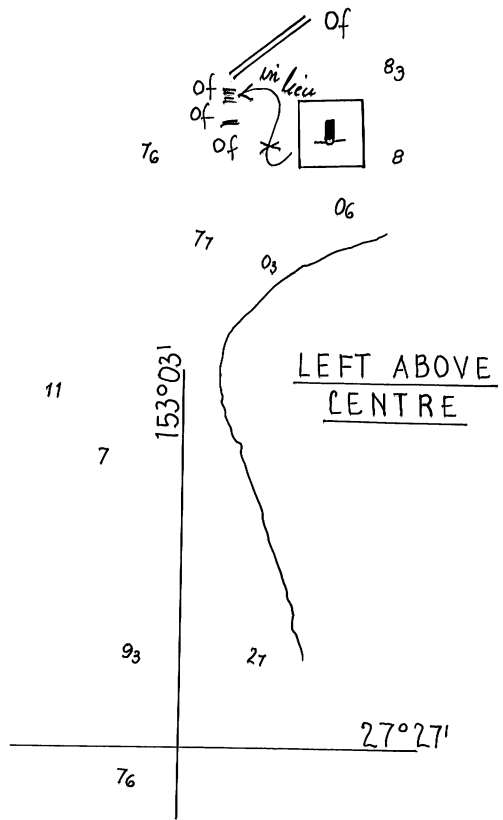
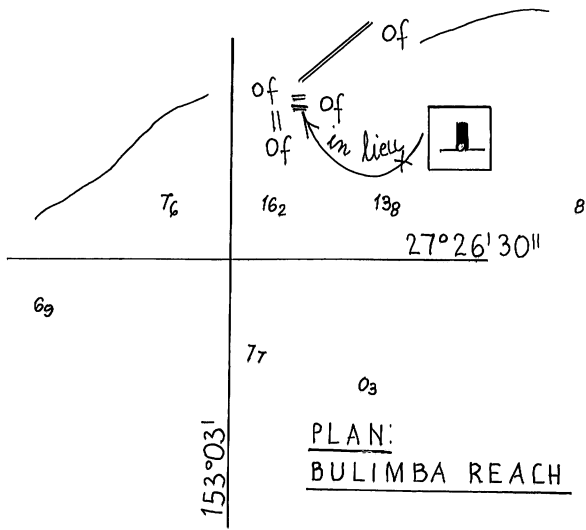

105/2010

408/2010

© Commonwealth of Australia 2010

AUS 238

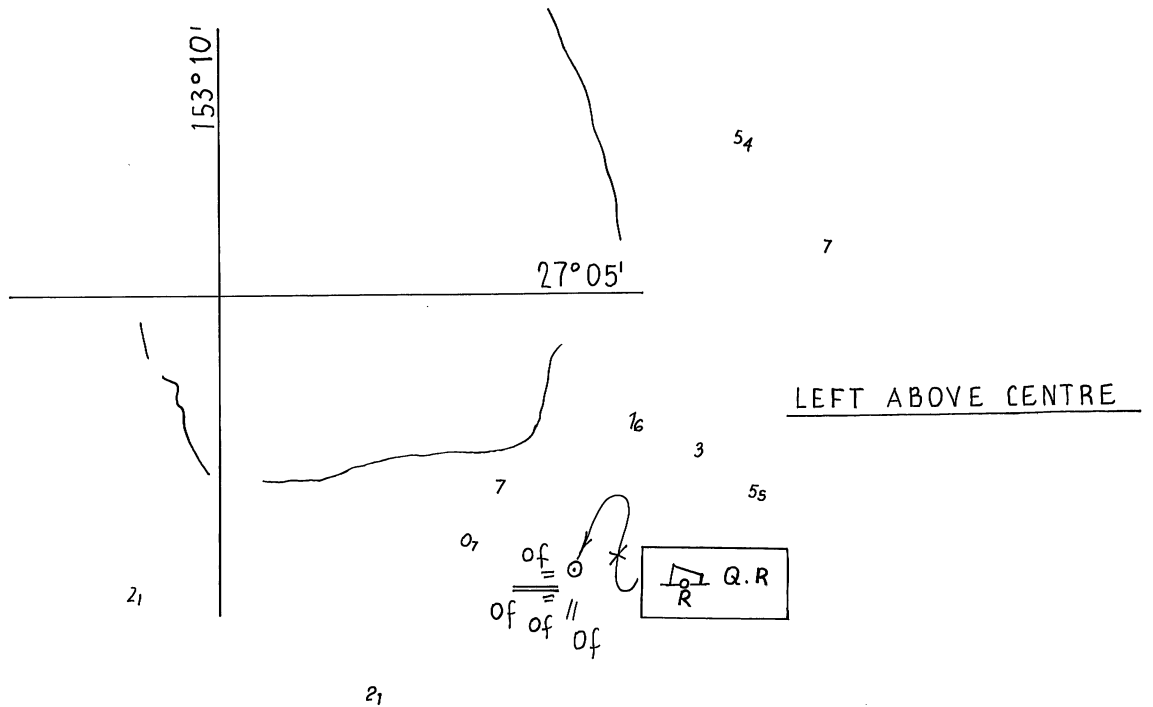

354/2010

409/2010

© Commonwealth of Australia 2010

AUS 236

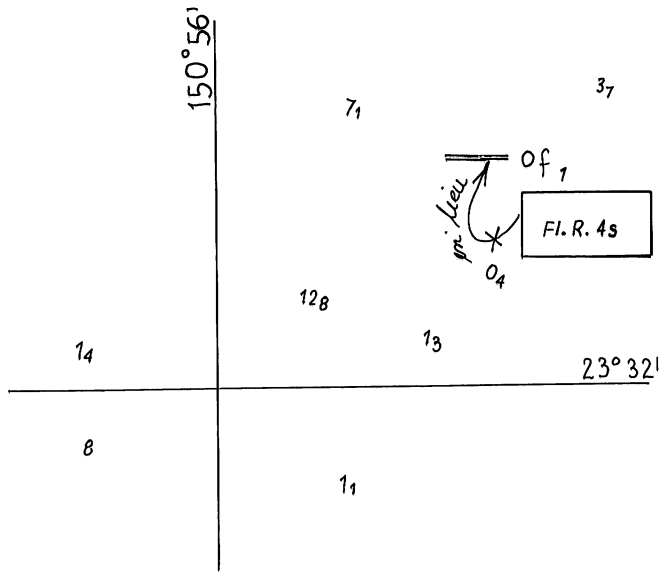

RIGHT BELOW CENTRE

355/2010

410/2010

© Commonwealth of Australia 2010

AUS 265

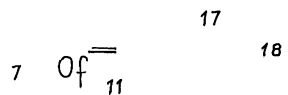

LEFT ABOVE CENTRE

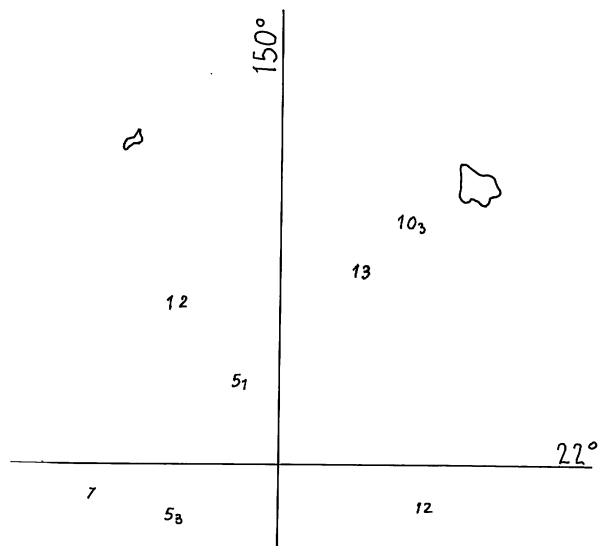

151/2010

411/2010

© Commonwealth of Australia 2010

AUS 426

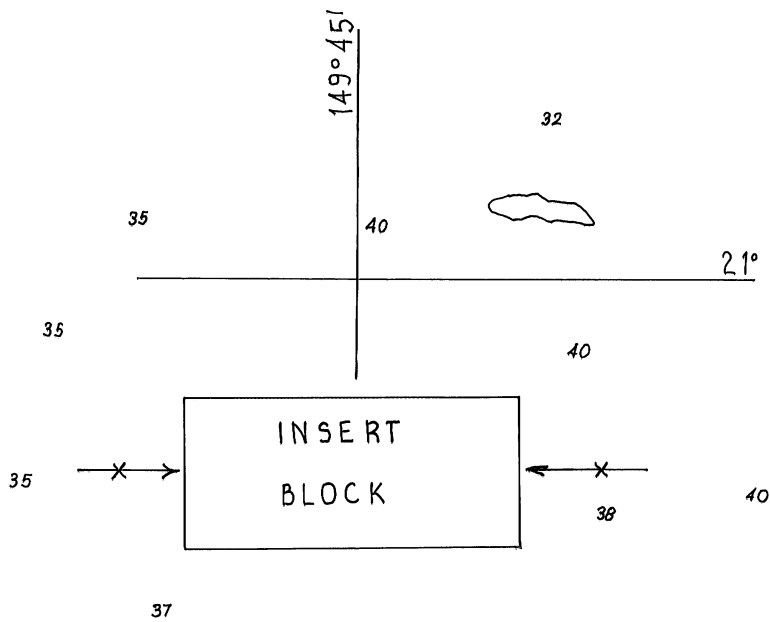

RIGHT BELOW CENTRE

1354/2009

411/2010

© Commonwealth of Australia 2010

AUS 824

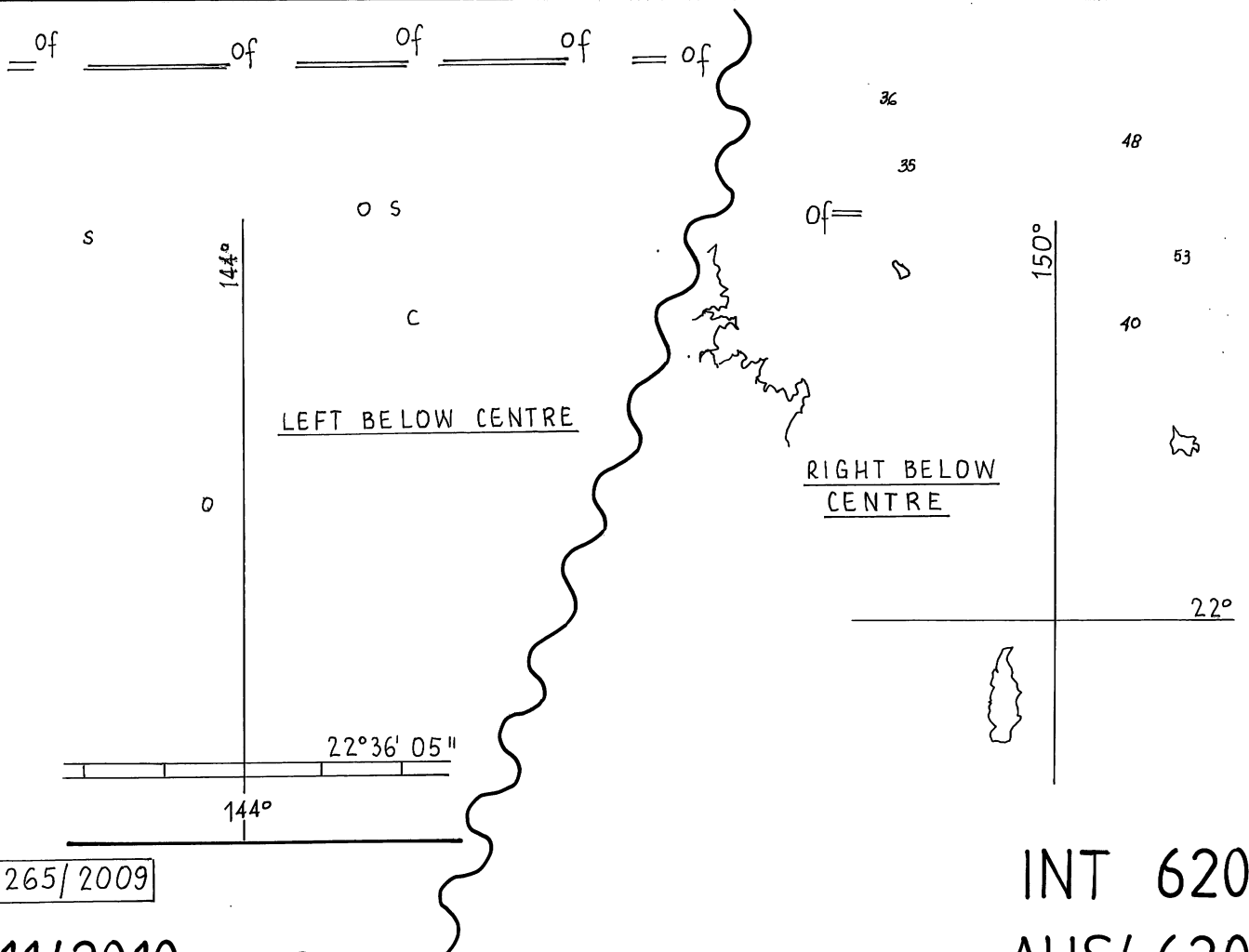

1265/2009

411/2010

© Commonwealth of Australia 2010

INT 620  
AUS4620



Of =

LEFT BELOW CENTRE

22°

150°

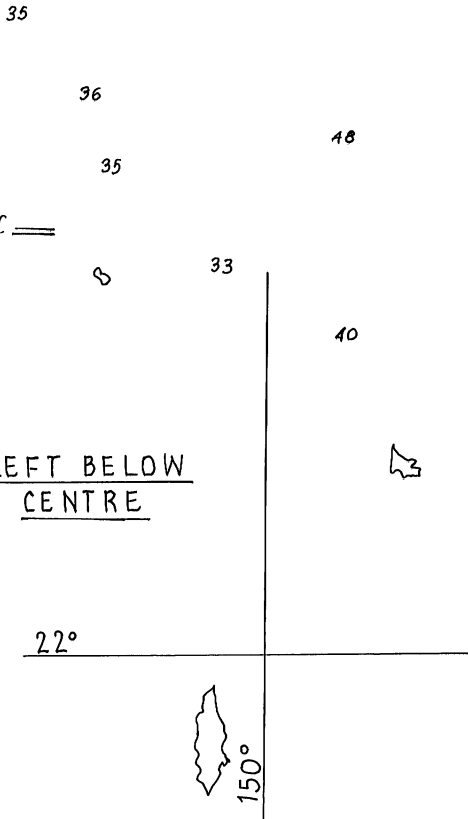

Of

Fl. 5M

RIGHT ABOVE CENTRE

156°

8°

3816

2466

2926

3208

472

311

646

151/2010

411,433/2010

© Commonwealth of Australia 2010

INT 621

AUS 4621

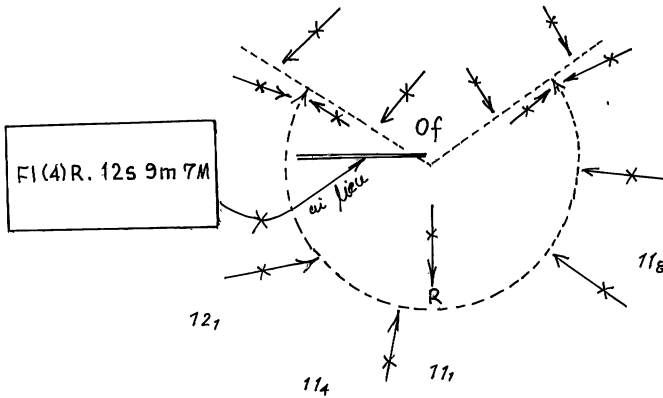

LEFT OF CENTRE

142° 16'

10° 32'

11

55

34

53

53

4

359/2010

412/2010

© Commonwealth of Australia 2010

AUS 293

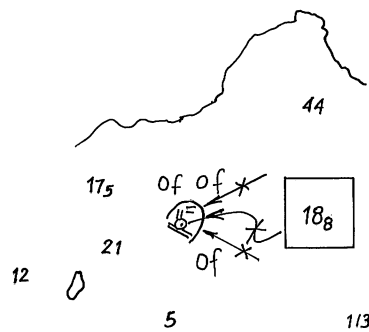
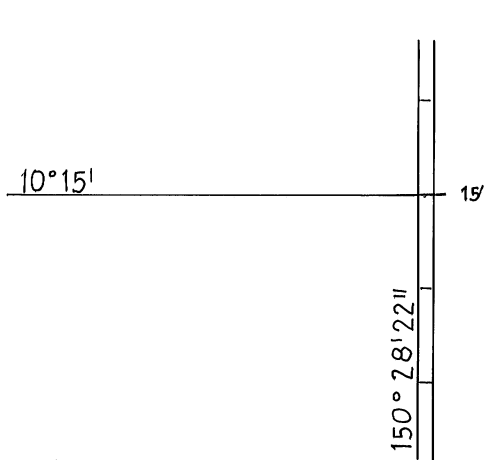

RIGHT ABOVE CENTRE

360/2009

413/2010

© Commonwealth of Australia 2010

AUS 507

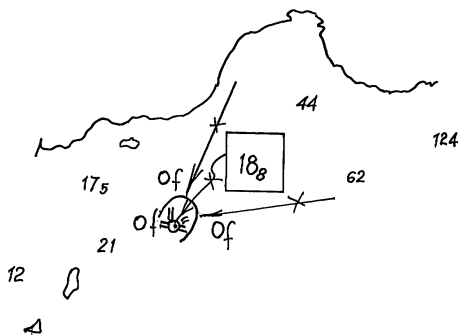
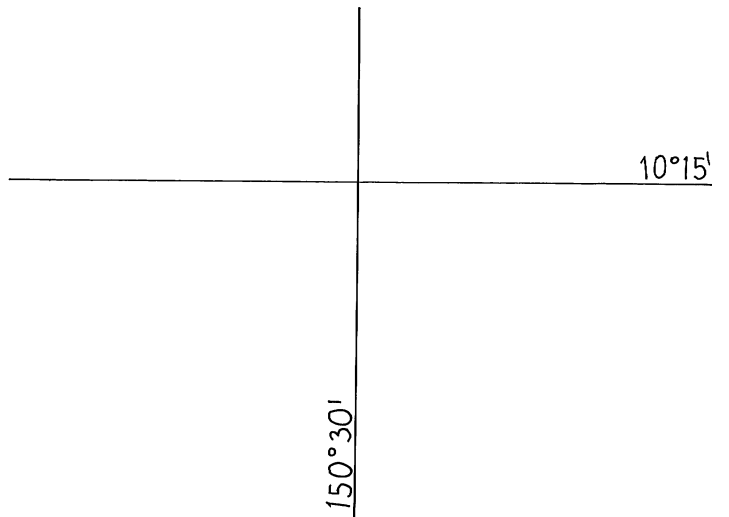

LEFT ABOVE CENTRE

251/2010

413/2010

© Commonwealth of Australia 2010

AUS 508

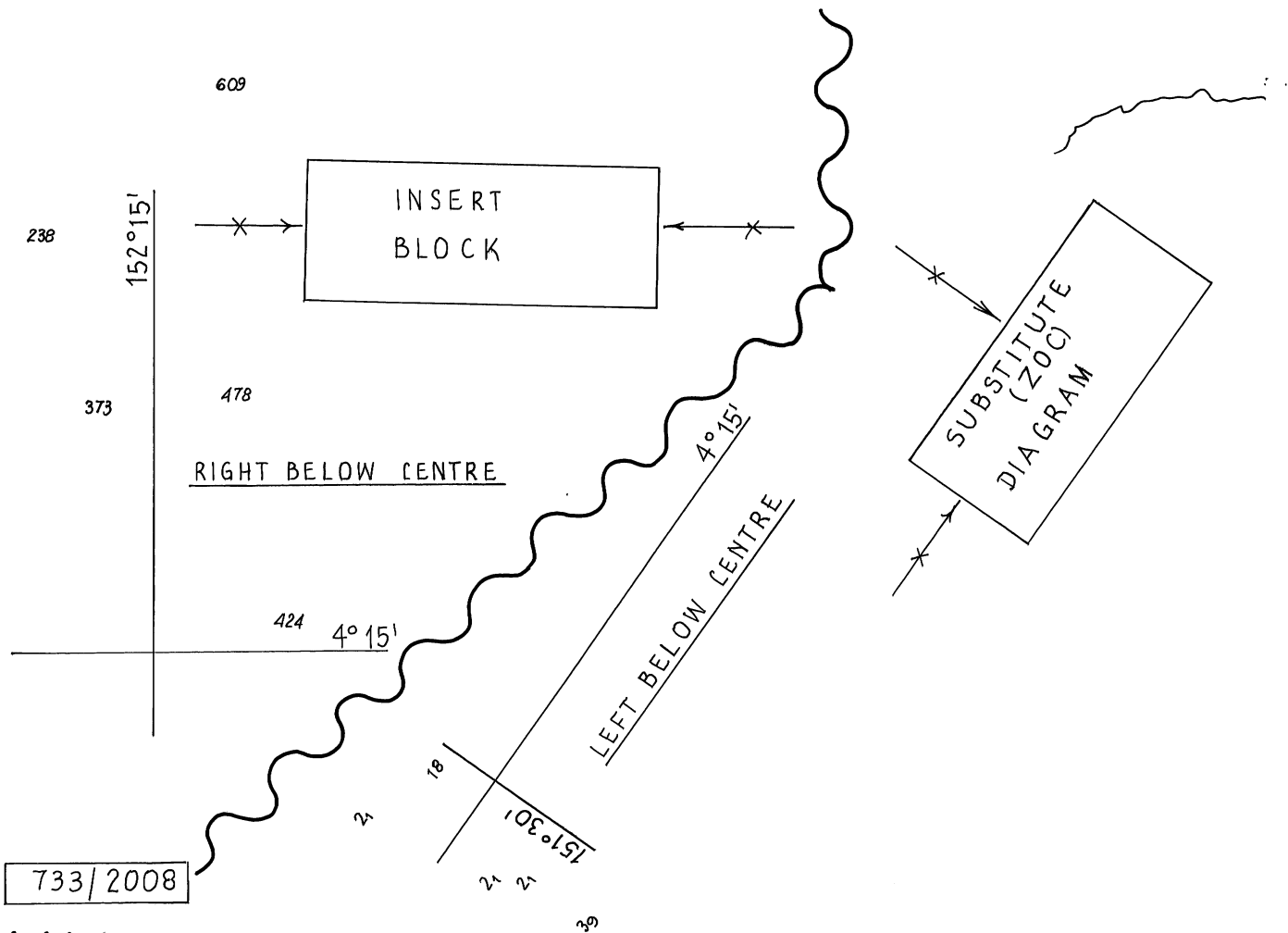

414/2010

© Commonwealth of Australia 2010

AUS 545

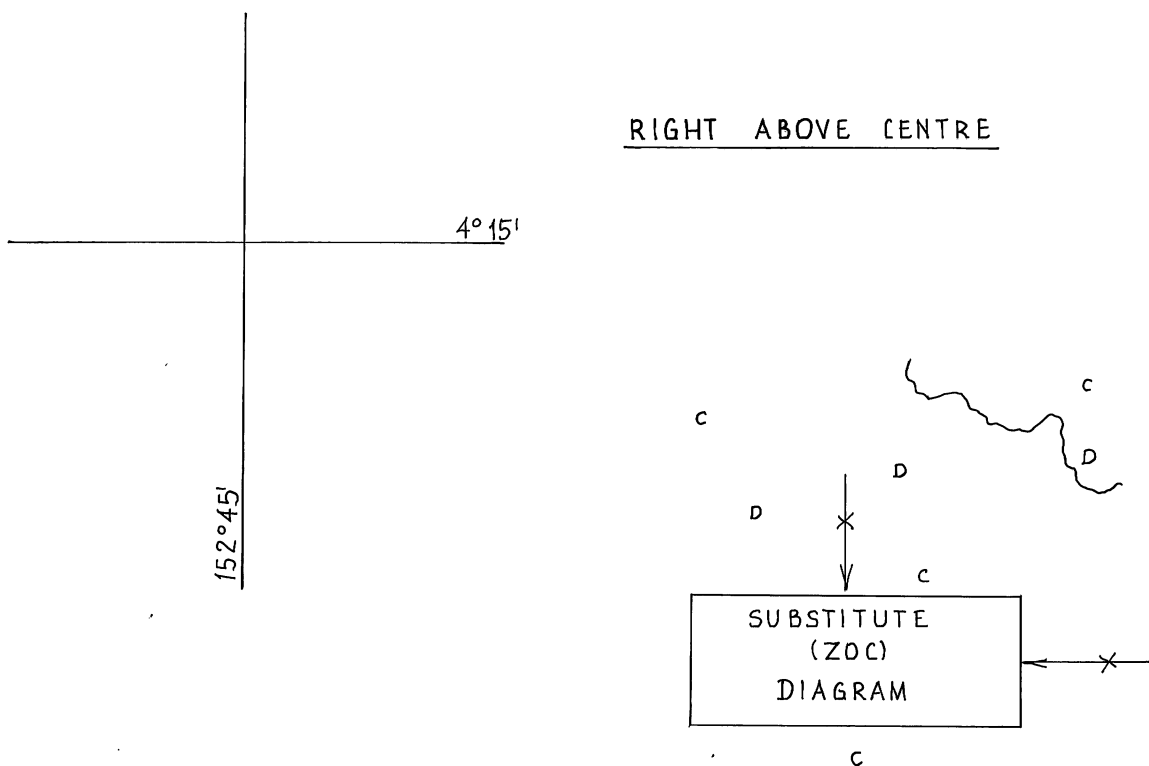

292/2010

414/2010

© Commonwealth of Australia 2010

AUS 554

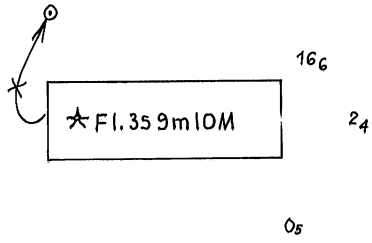

PLAN:  
PORT OF BASAMUK

146° 08' 30"

5° 32' 30"

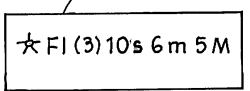
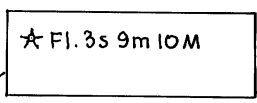
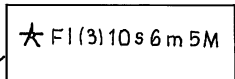
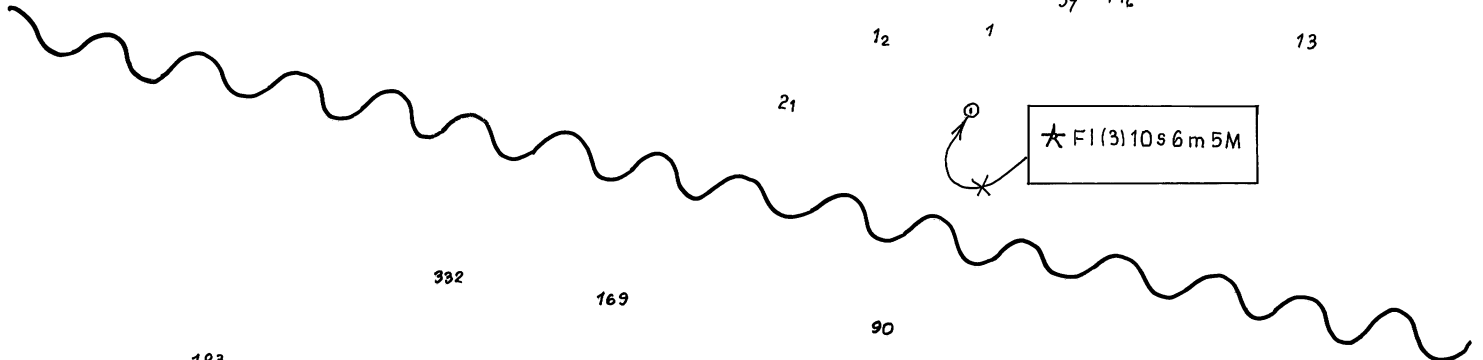

RIGHT ABOVE CENTRE

146° 09'

5° 33'

NC-5-12-2008

415/2010

© commonwealth of Australia 2010

AUS 645

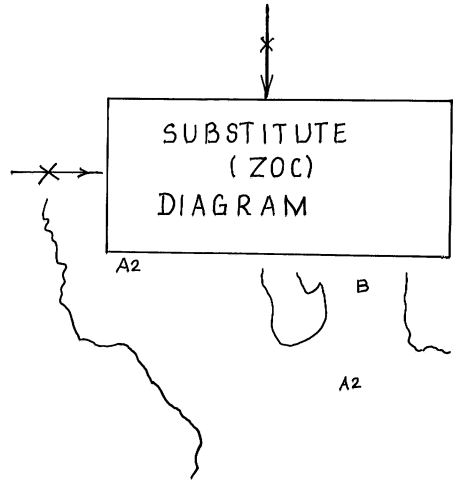
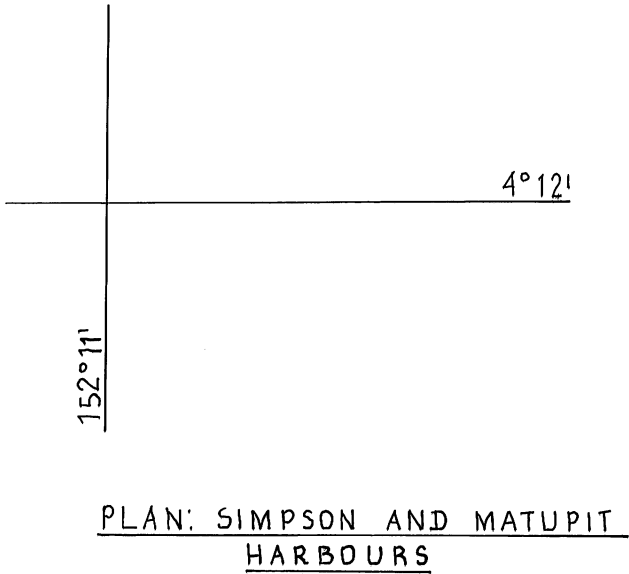

252/2010

414/2010

© Commonwealth of Australia 2010

AUS 680

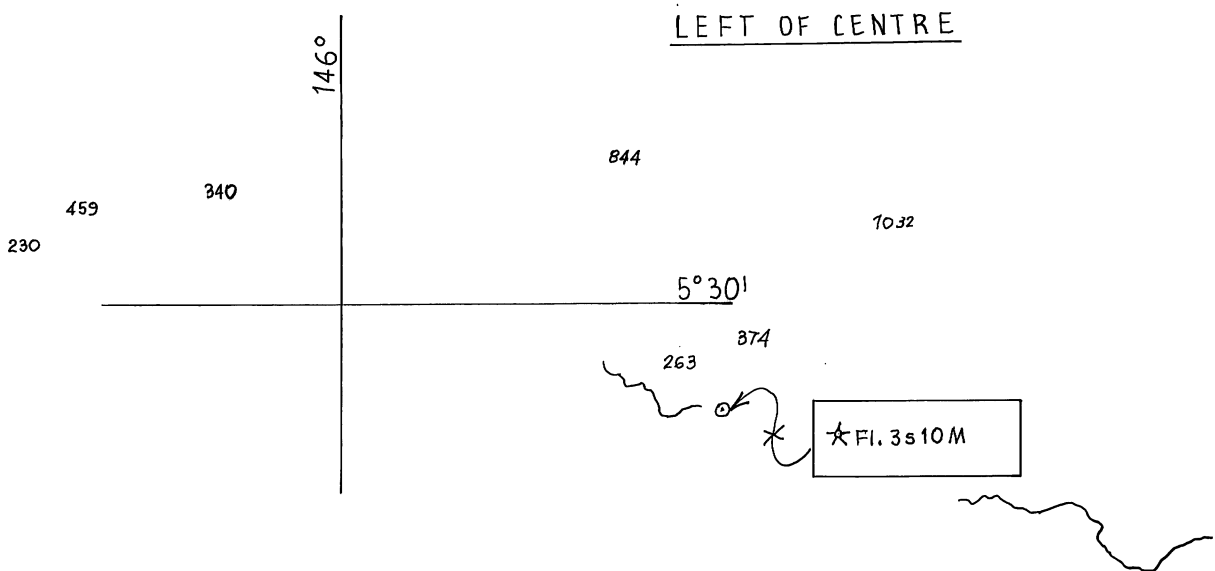

1359/2009

415/2010

© Commonwealth of Australia 2010

AUS 387

117

125°

*pro. magenta*  
*pro. blue*

(U)

110

325

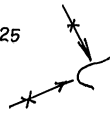

197

169

208

214

75

104

113

12°

101

RIGHT OF CENTRE

103

RIGHT ABOVE CENTRE

106

125° 30'

111

11° 30'

96

1160/2009

(On certain copies only)

416/2010

© Commonwealth of Australia 2010

AUS 314

RIGHT BELOW CENTRE

412

330

353

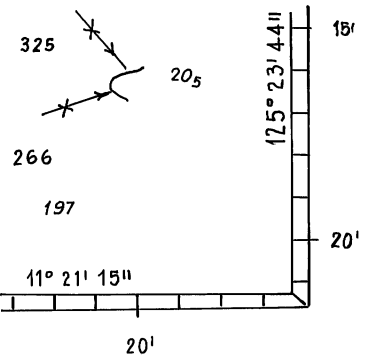

648/2009

416/2010

© Commonwealth of Australia 2010

AUS 321

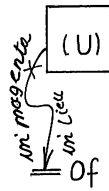
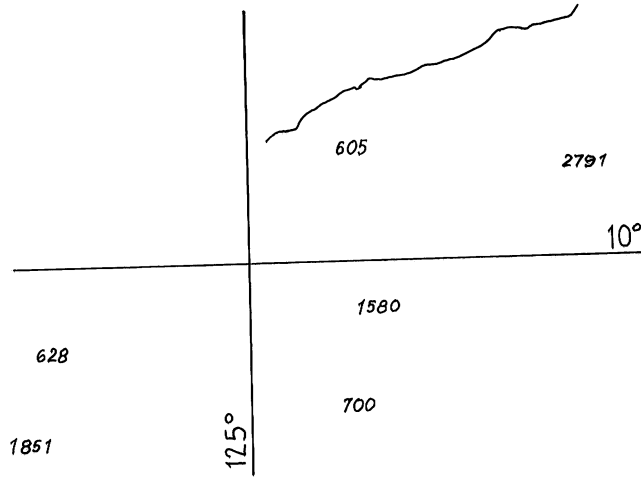

LEFT OF CENTRE

208/2010

(On certain copies only)

INT 603

416/2010

© Commonwealth of Australia 2010

AUS4603

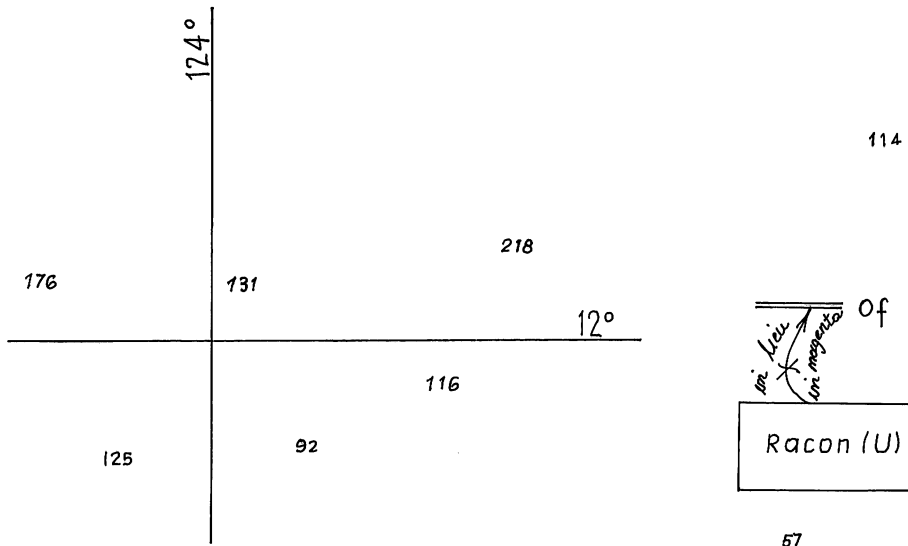

LEFT BELOW CENTRE

(On certain copies only)

254/2010

INT 721

416/2010

© Commonwealth of Australia 2010

AUS4721

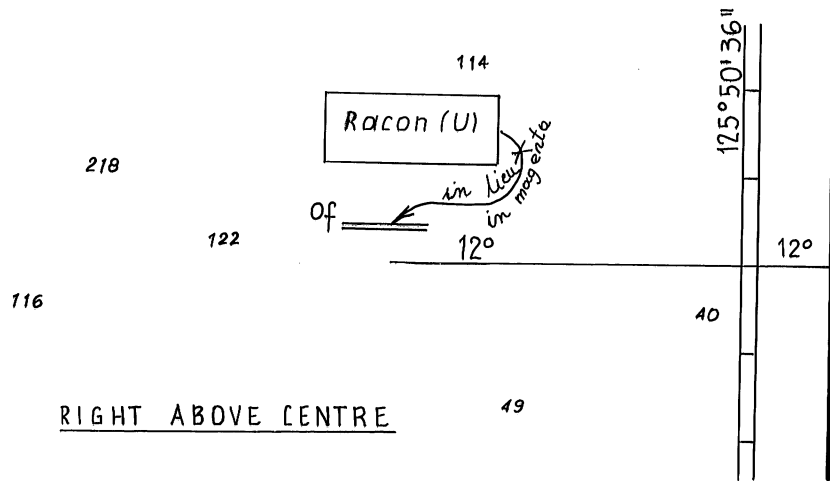

254/2010

(On certain copies only)

INT 722

416/2010

© Commonwealth of Australia 2010

AUS 4722

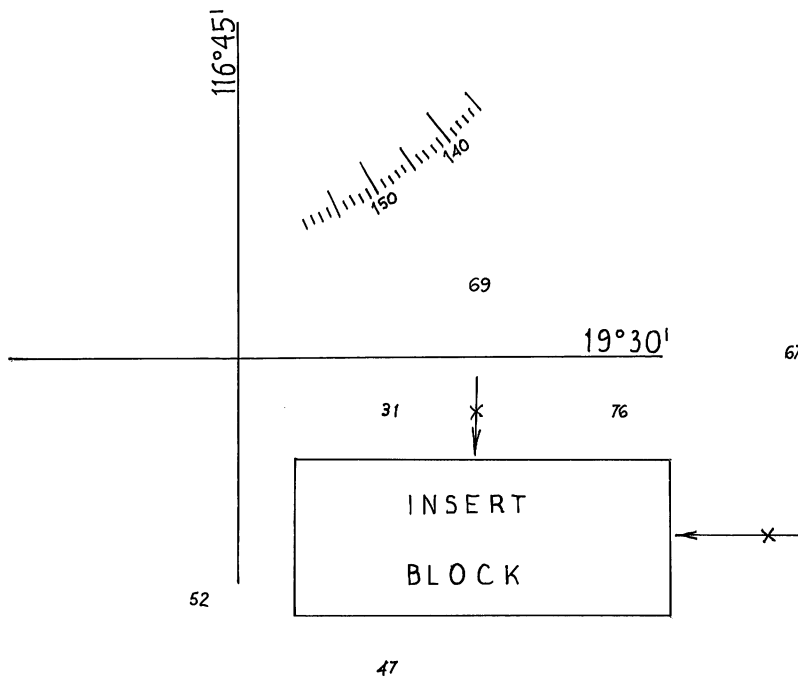

ABOVE CENTRE

363/2010

417/2010

© Commonwealth of Australia 2010

AUS 741

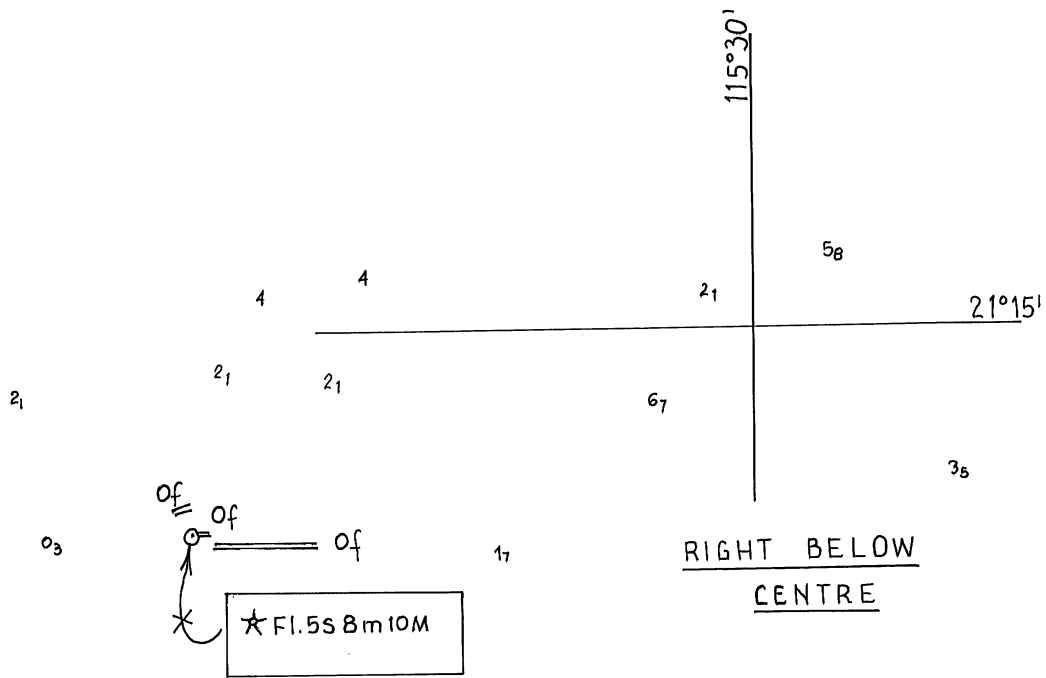

1362/2009

418/2010

© Commonwealth of Australia 2010

AUS 63

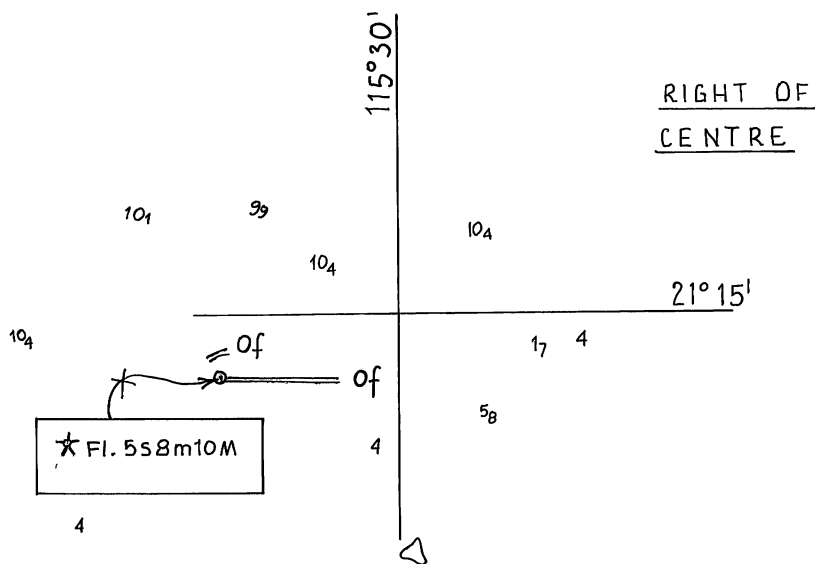

300/2010

418/2010

© Commonwealth of Australia 2010

AUS 743

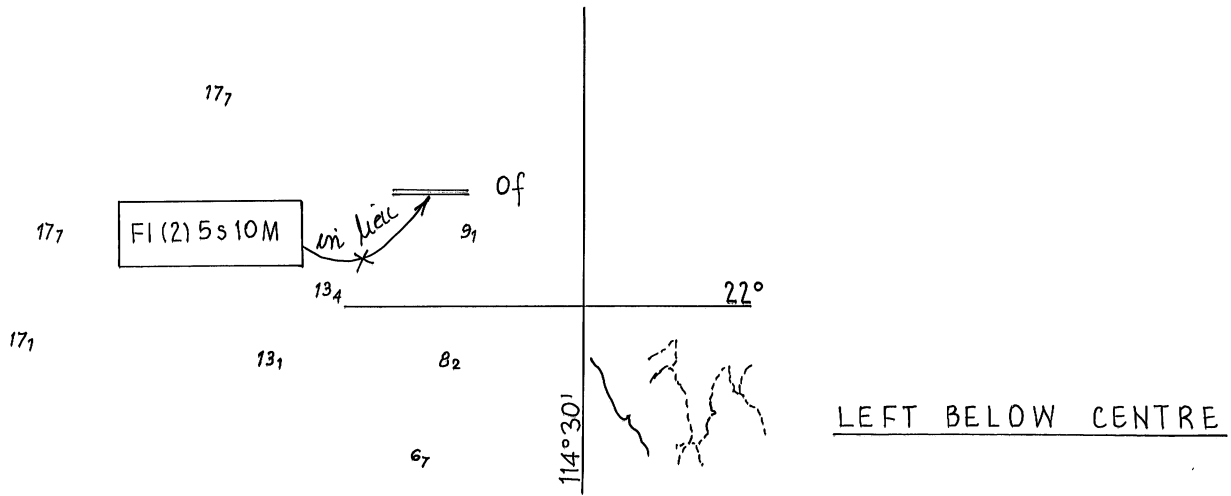

300/2010

419/2010

© Commonwealth of Australia 2010

AUS 328

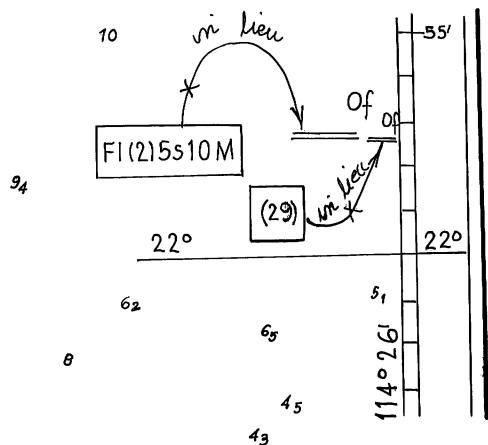

RIGHT BELOW CENTRE

258/2010

419/2010

© Commonwealth of Australia 2010

AUS 329



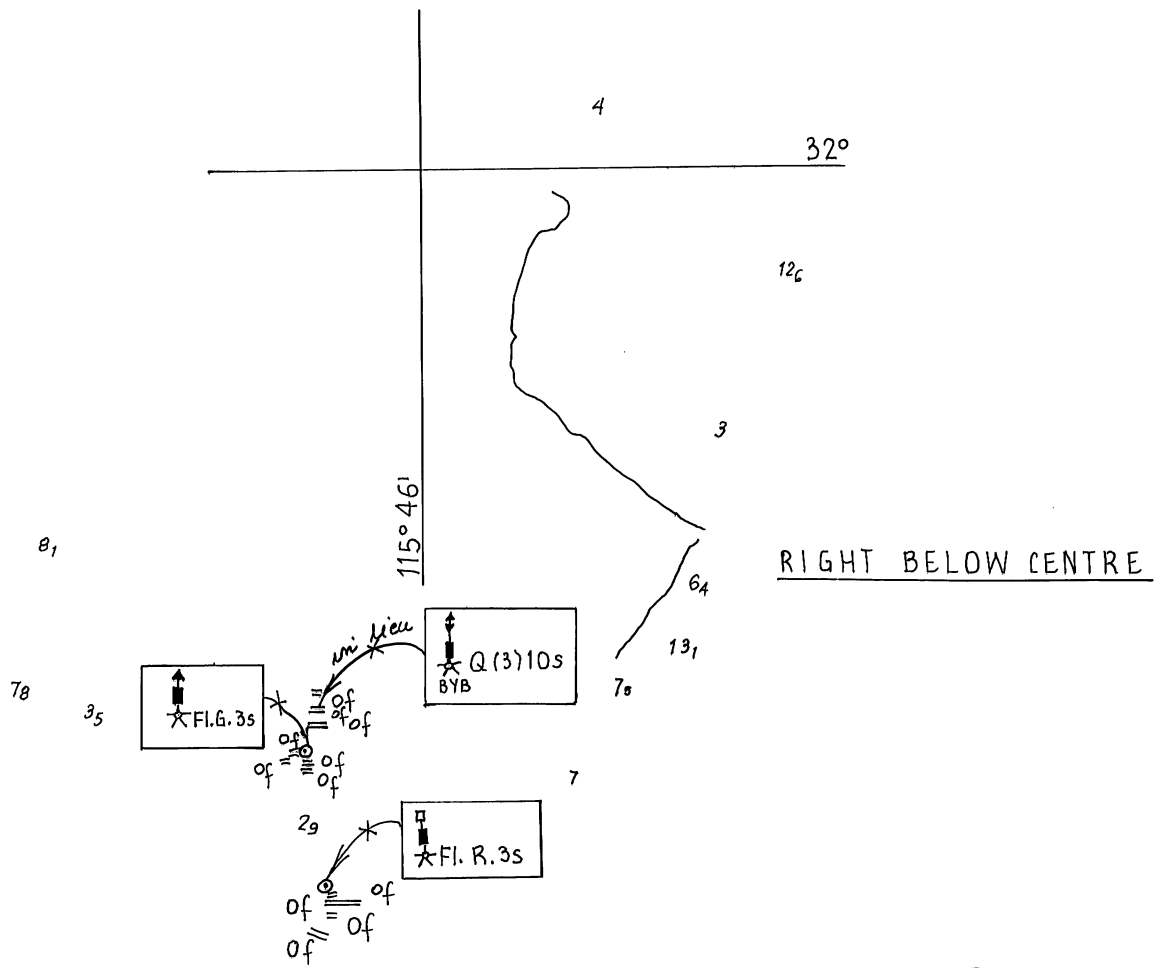

1313/2009

421/2010

© Commonwealth of Australia 2010

AUS 112

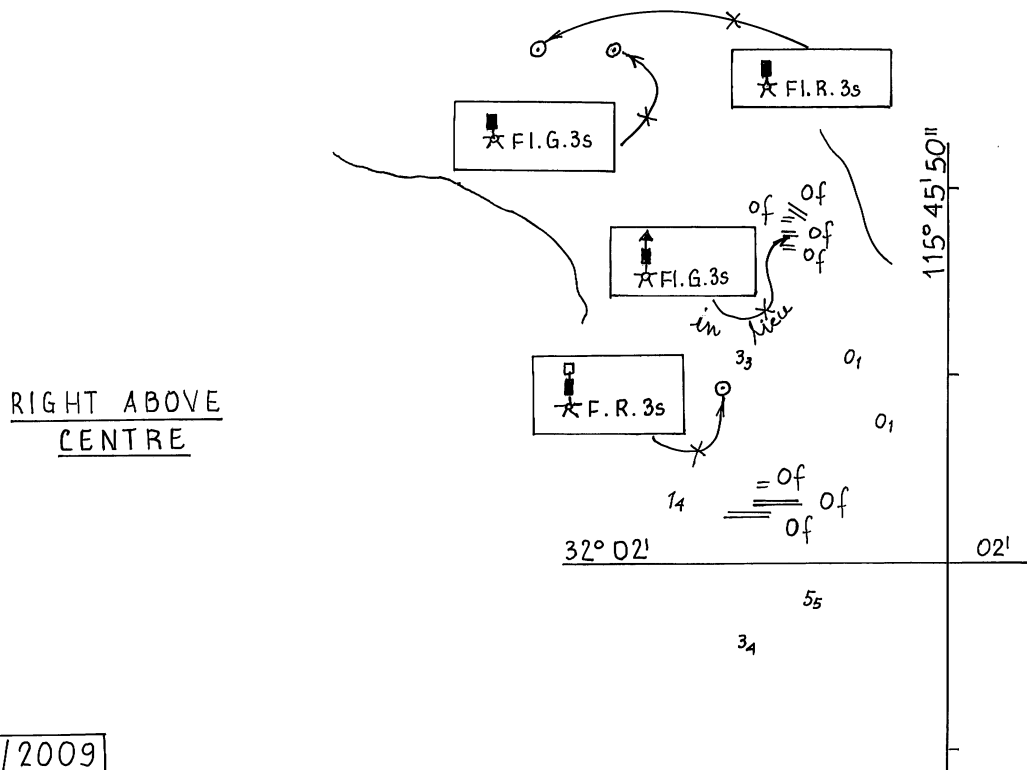

1313/2009

421/2010

© Commonwealth of Australia 2010

AUS 113

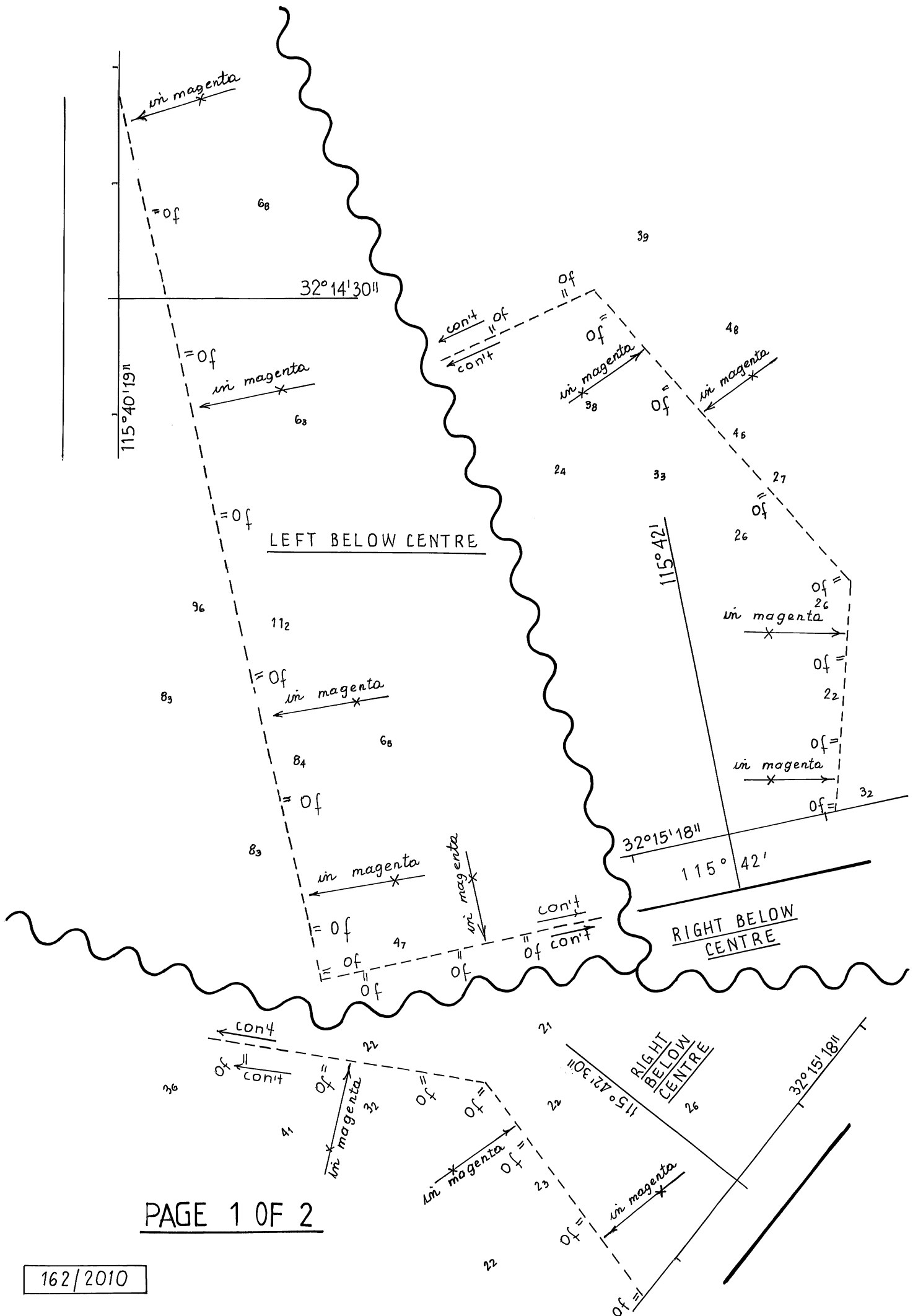

PAGE 1 OF 2

162/2010

422/2010

© Commonwealth of Australia 2010

AUS 111

32° 14' 30"

115° 42'

RIGHT BELOW CENTRE

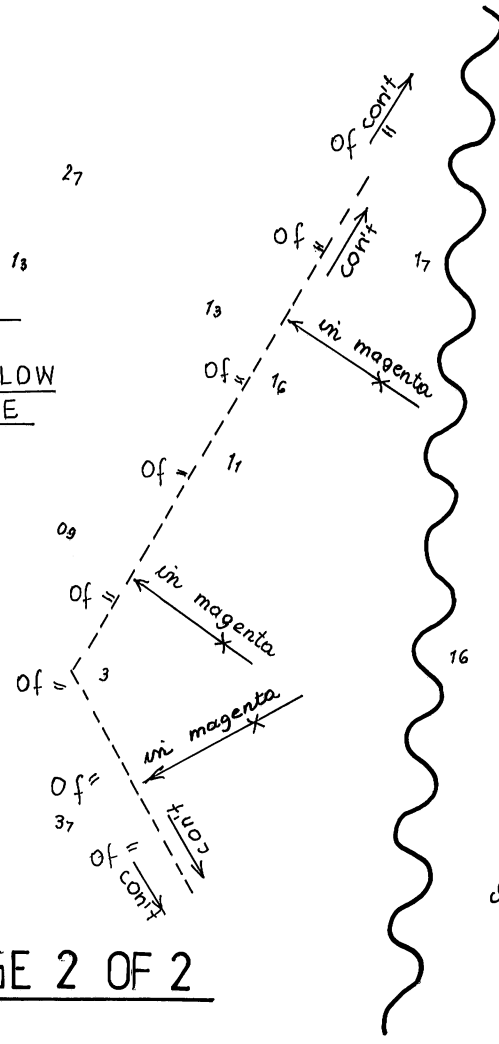

115° 42' 30"

32° 14'

RIGHT BELOW CENTRE

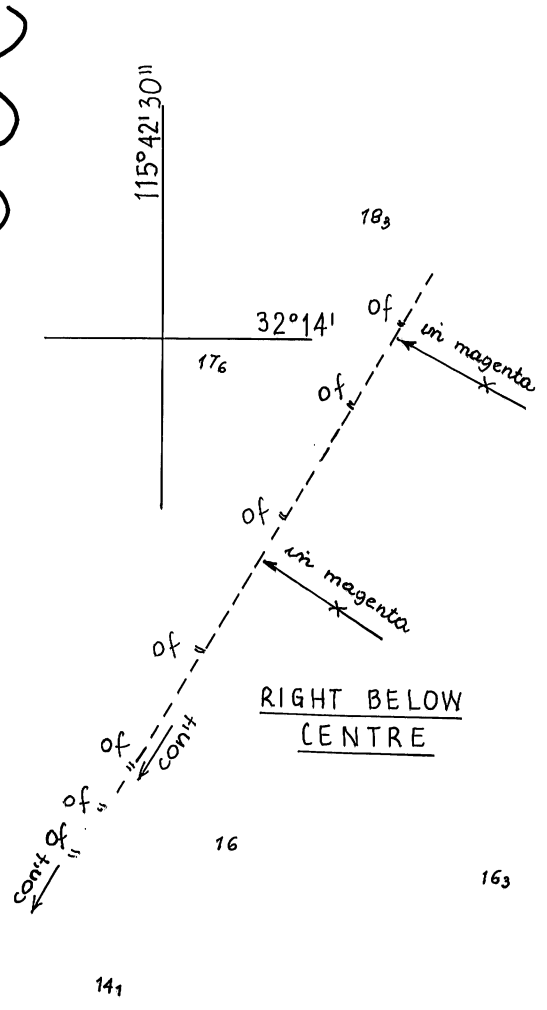

162/2010

PAGE 2 OF 2

422/2010

© Commonwealth of Australia 2010

AUS 111

32° 10'

115° 40'

BELOW CENTRE

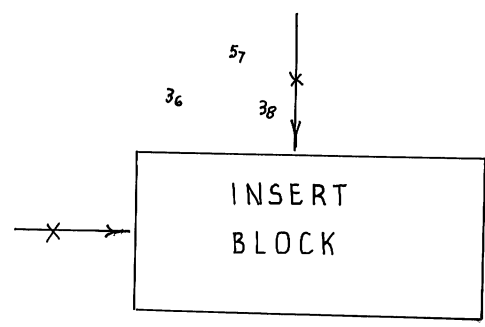

32° 12'

RIGHT BELOW CENTRE

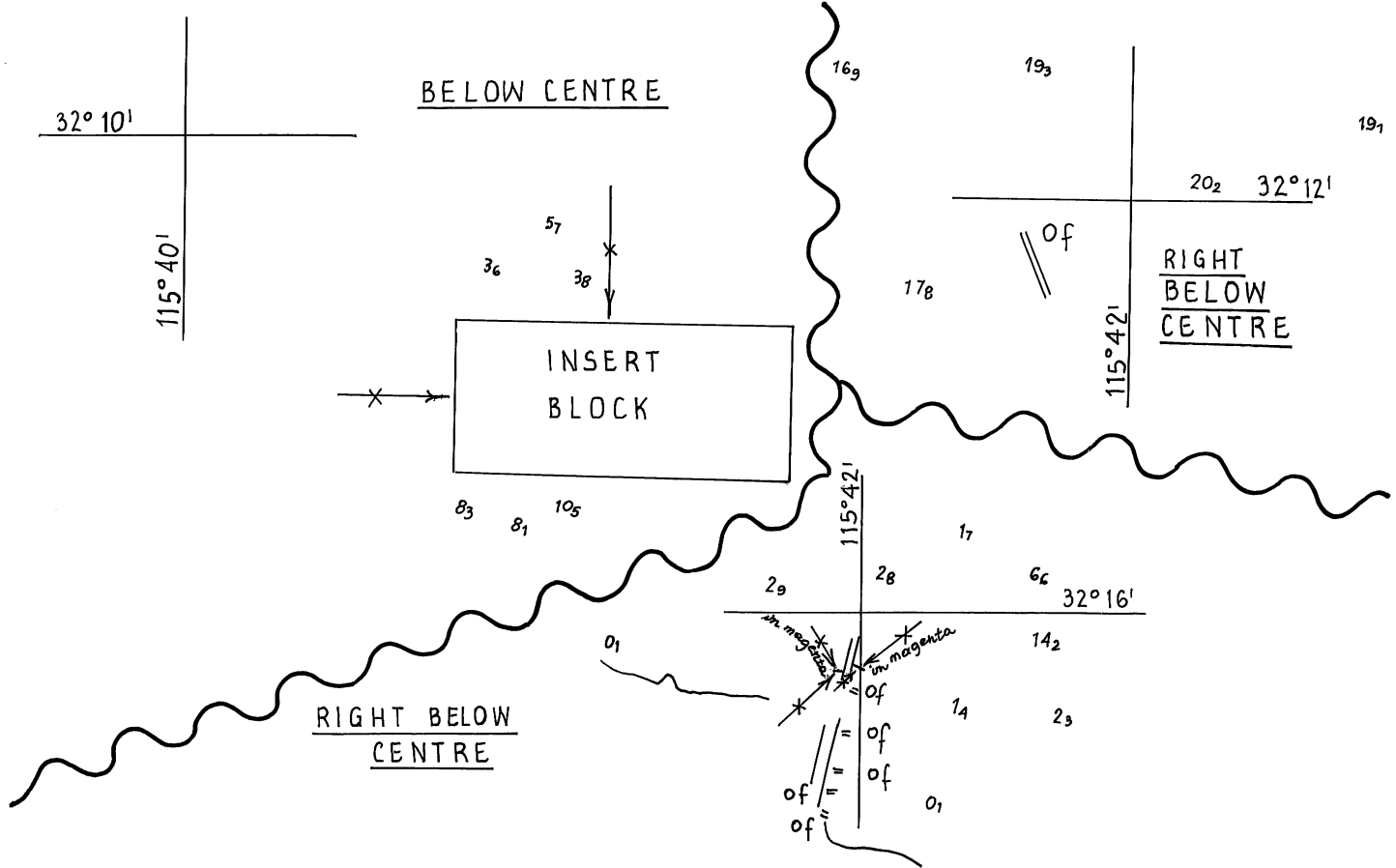

163/2010

422/2010

© Commonwealth of Australia 2010

AUS 117

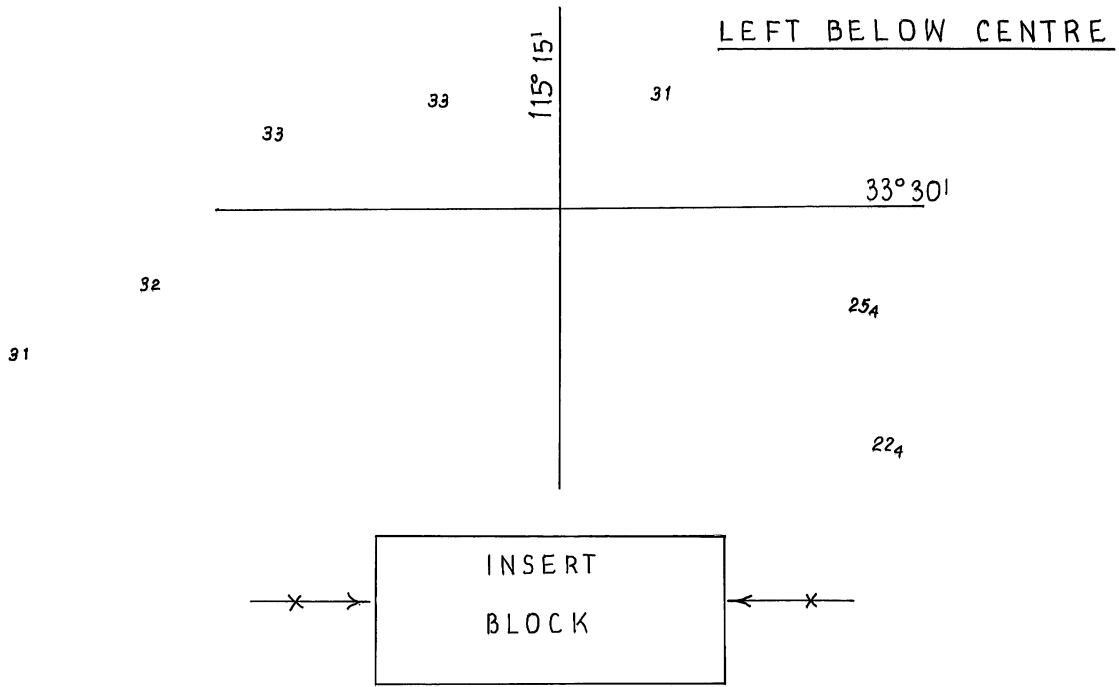

366/2010

423/2010

© Commonwealth of Australia 2010

AUS 755

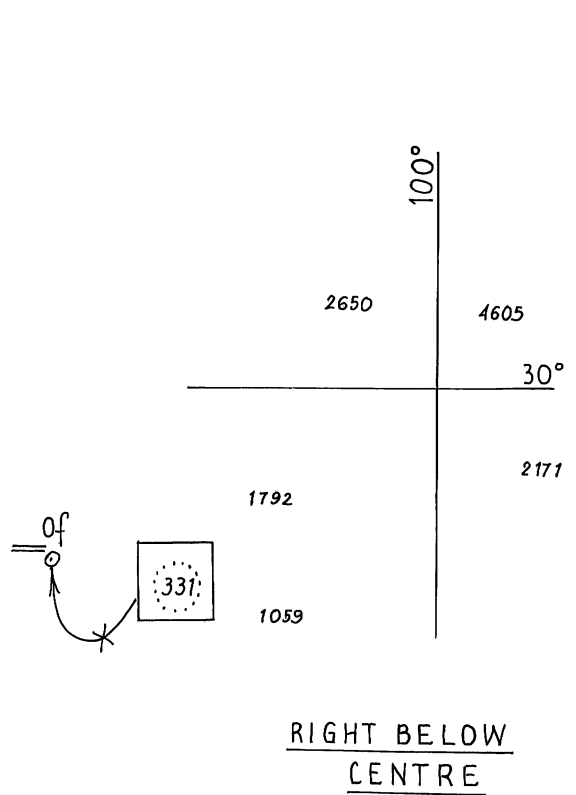
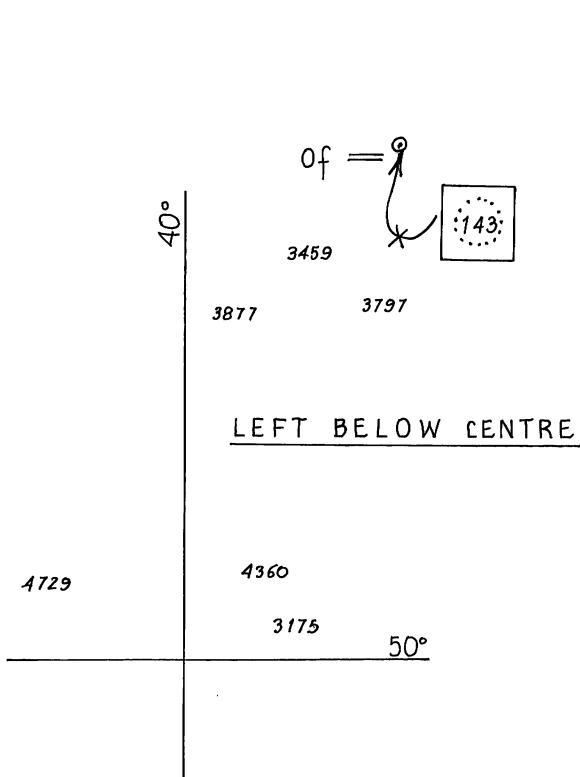

260/2010

424/2010

© Commonwealth of Australia 2010

INT 70  
AUS4070

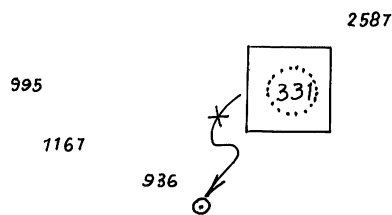
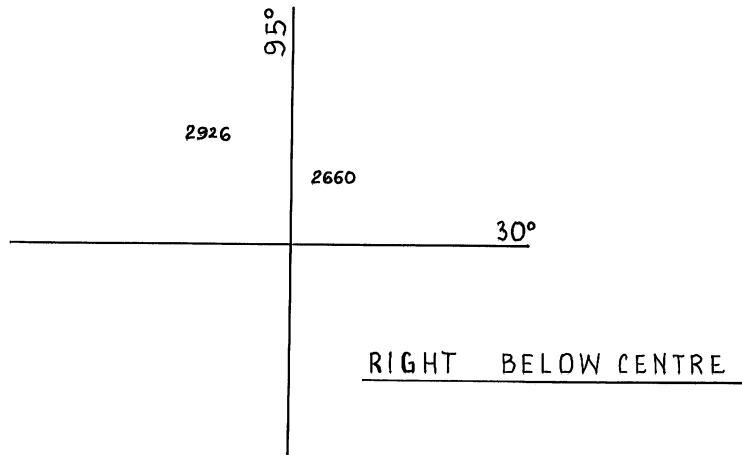

260/2010

424/2010

© Commonwealth of Australia 2010

INT 714  
AUS 4714

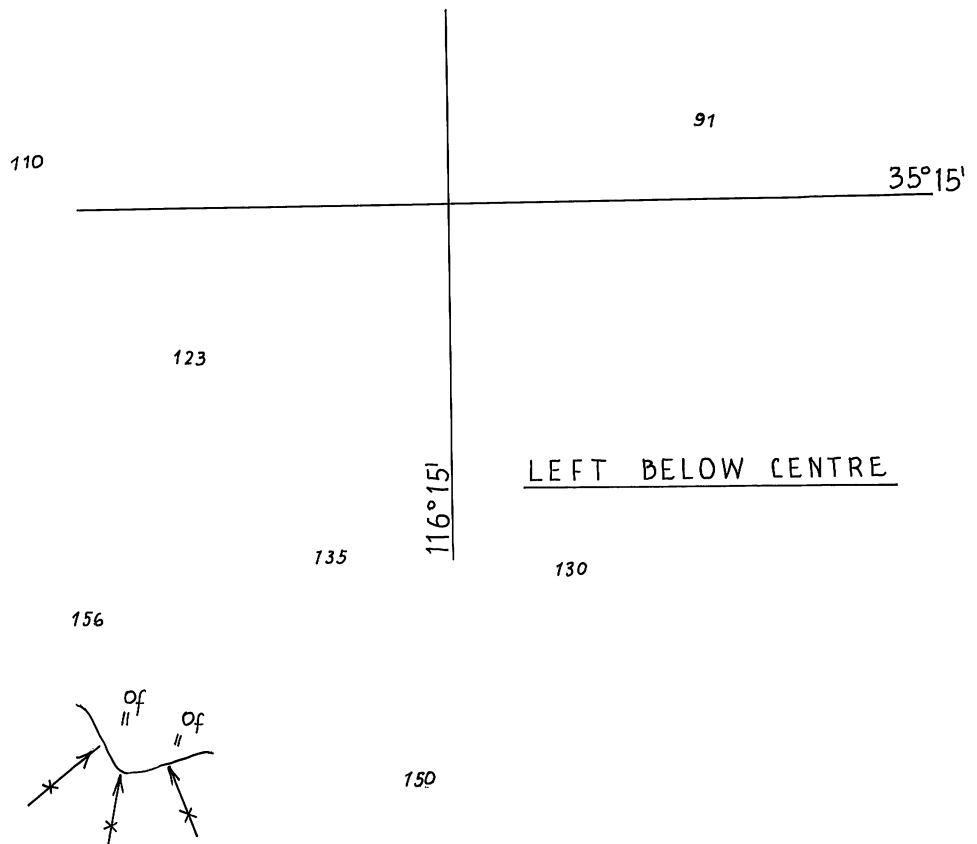

309/2009

425/2010

© Commonwealth of Australia 2010

AUS 758

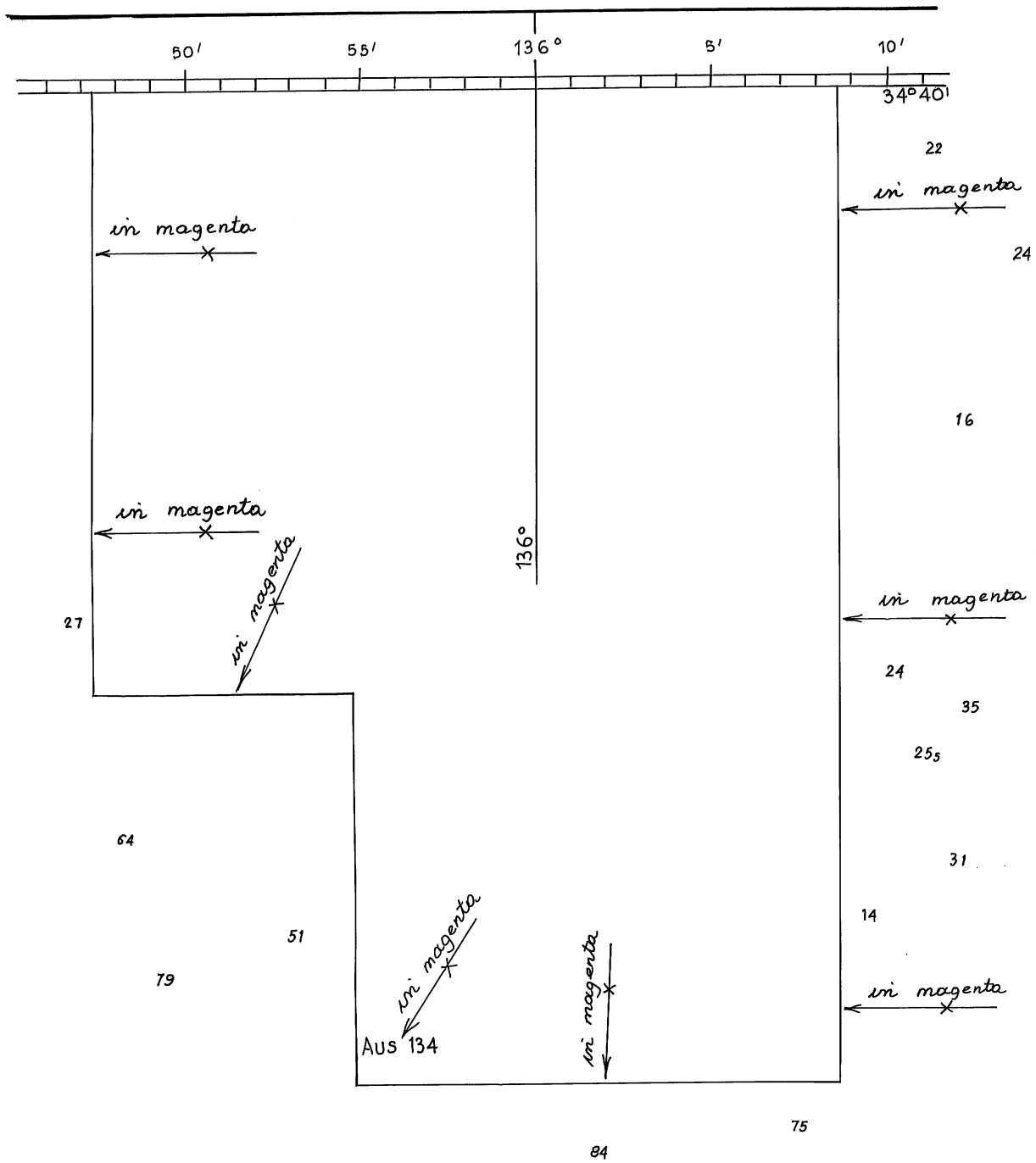

RIGHT ABOVE CENTRE

304/2010

426/2010

© Commonwealth of Australia 2010

AUS 343

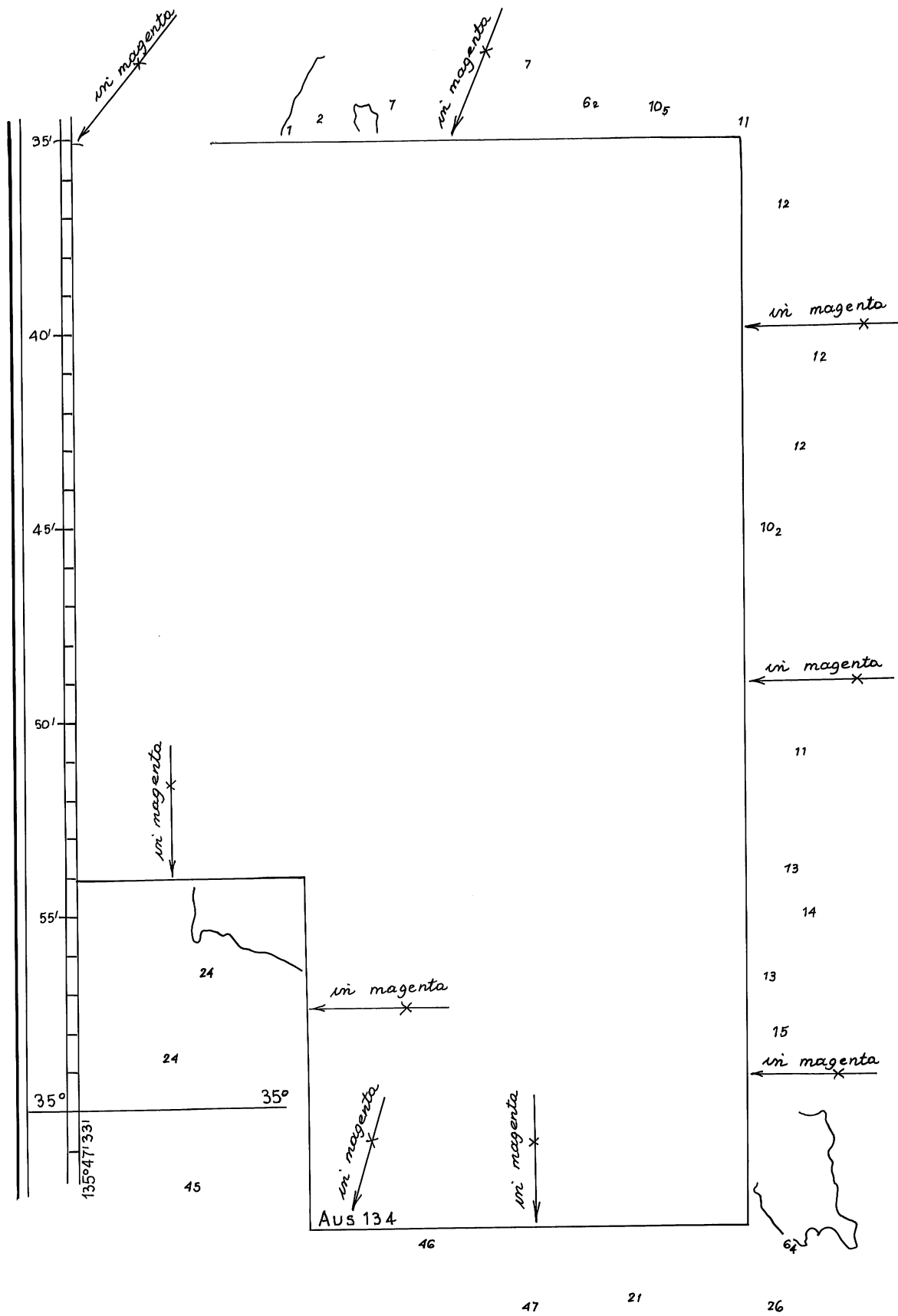

LEFT ABOVE CENTRE

367/2010

426/2010

© Commonwealth of Australia 2010

AUS 345

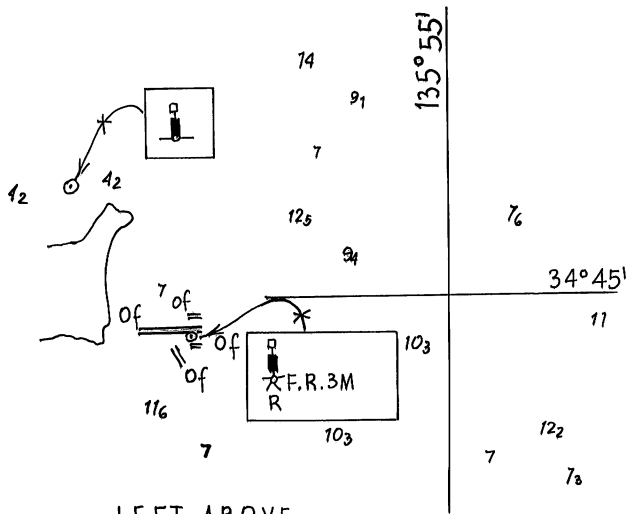

LEFT ABOVE CENTRE

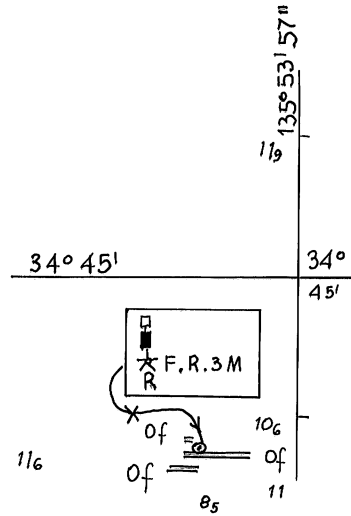

PLAN: PROPER BAY

100/2008

427/2010

© commonwealth of Australia 2010

AUS 134

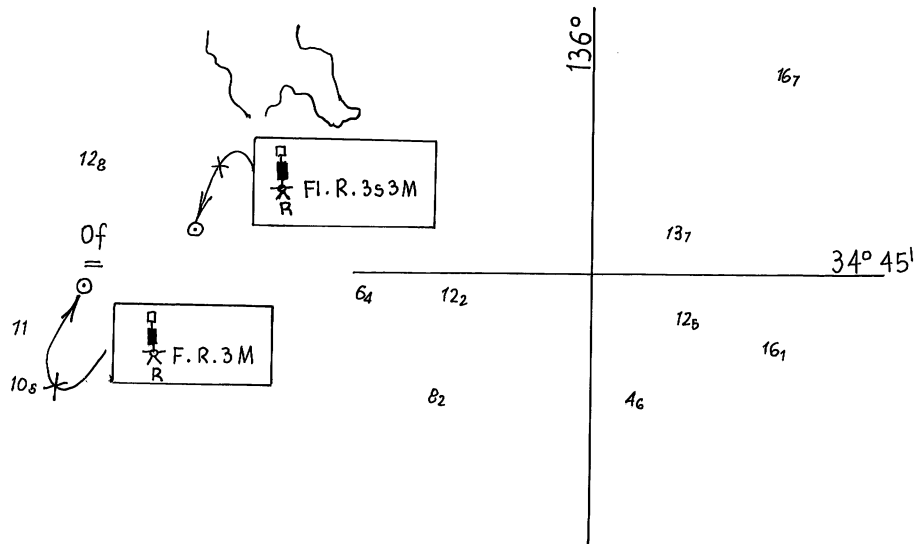

LEFT ABOVE CENTRE

304/2010

427/2010

© commonwealth of Australia 2010

AUS 776

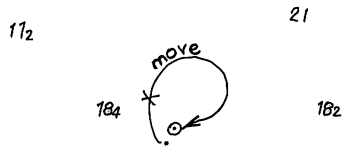
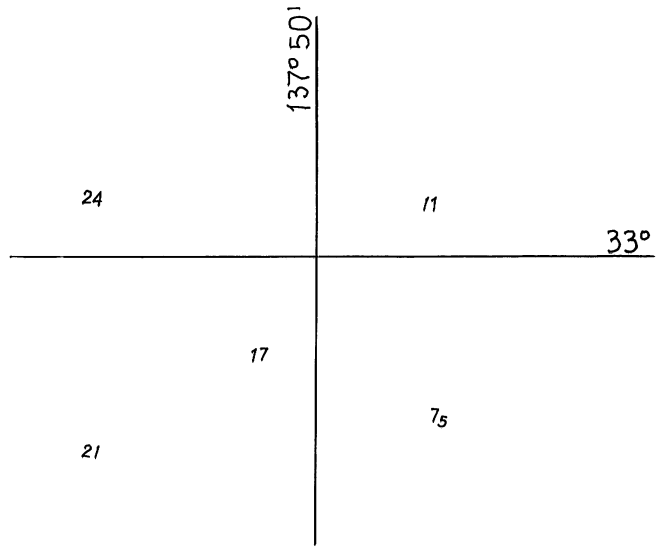
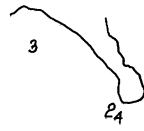

BELOW CENTRE

68/2009

428/2010

© Commonwealth of Australia 2010

AUS 136

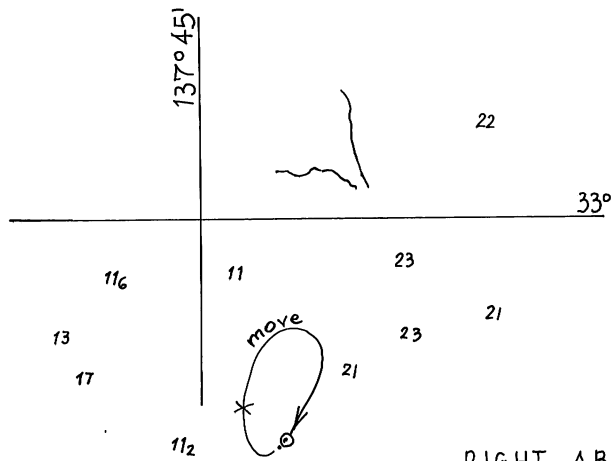

RIGHT ABOVE CENTRE

305/2010

428/2010

© commonwealth of Australia 2010

AUS 778

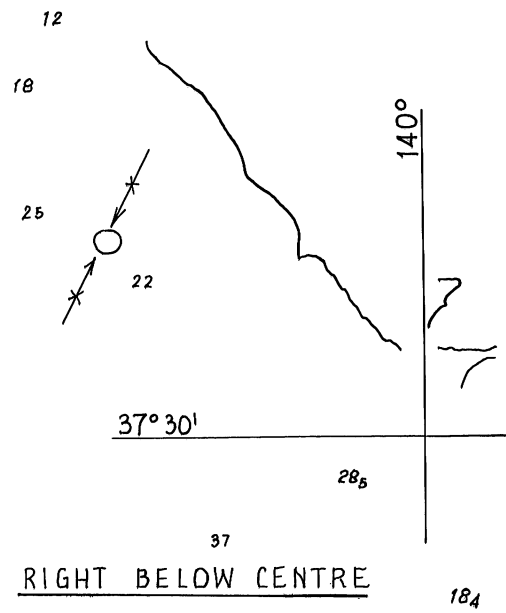
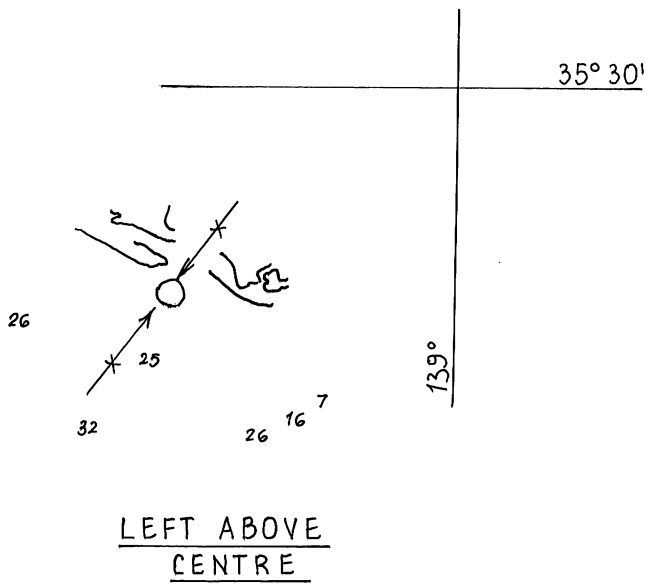

609/2009

429/2010

© Commonwealth of Australia 2010

AUS 347

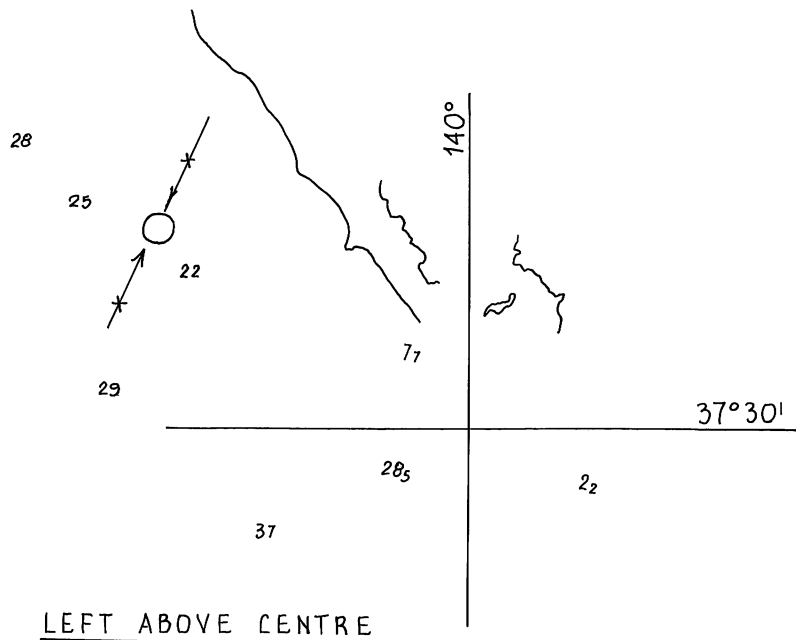

265/2010

429/2010

© Commonwealth of Australia 2010

AUS 348

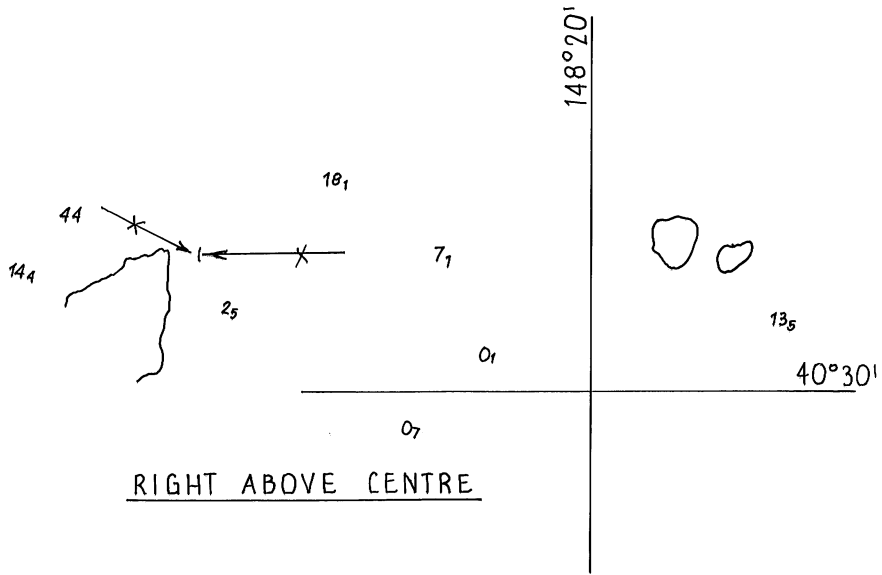

527/2007

430/2010

© Commonwealth of Australia 2010

AUS 798

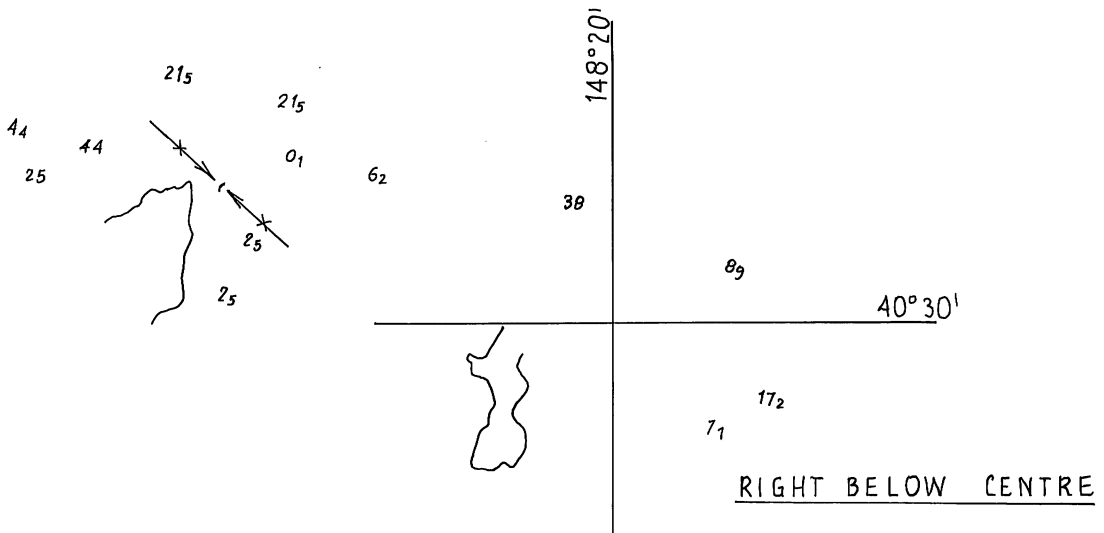

493/2009

430/2010

© Commonwealth of Australia 2010

AUS 800

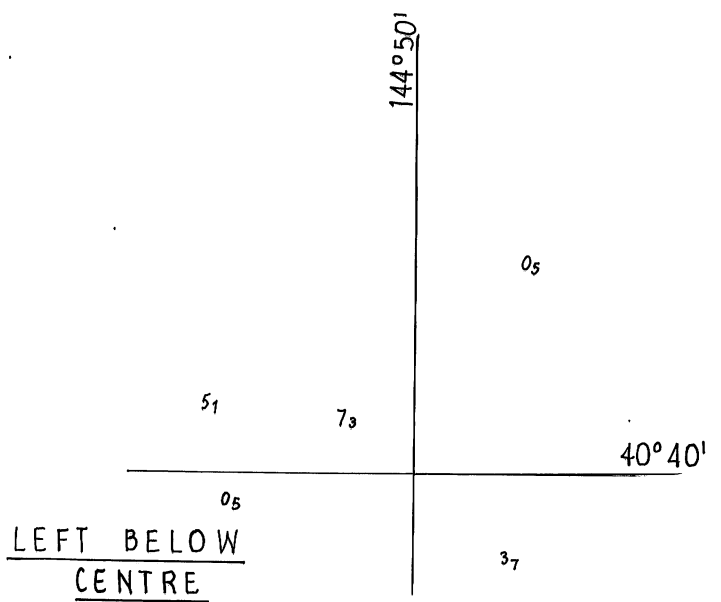
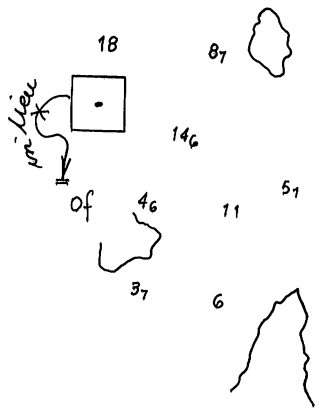

120/2010

431/2010

© Commonwealth of Australia 2010

AUS 790

RIGHT BELOW CENTRE

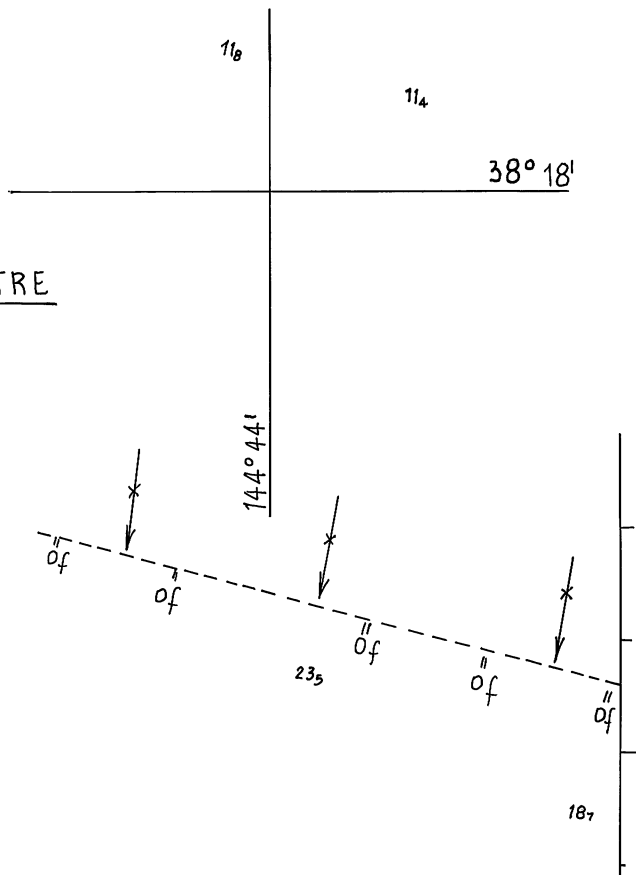

215/2010

432/2010

© Commonwealth of Australia 2010

AUS 144

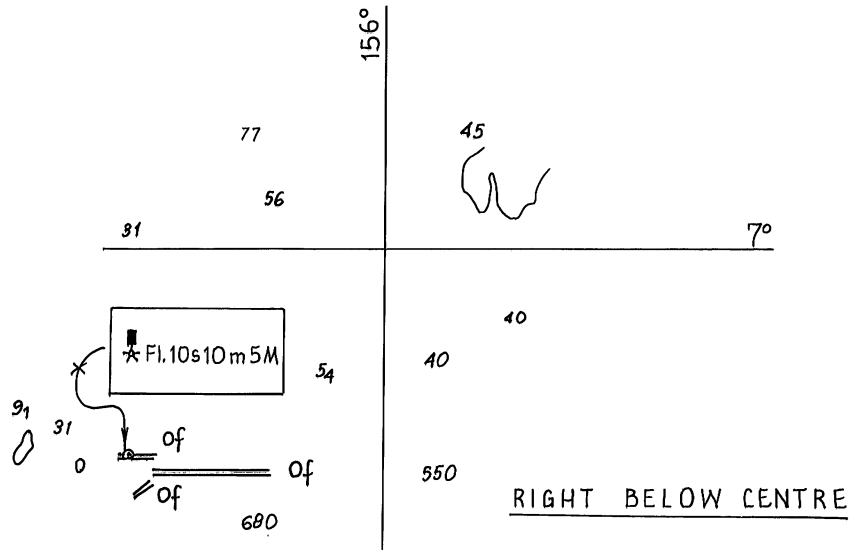

1219/2009

433/2010

© Commonwealth of Australia 2010

AUS 399

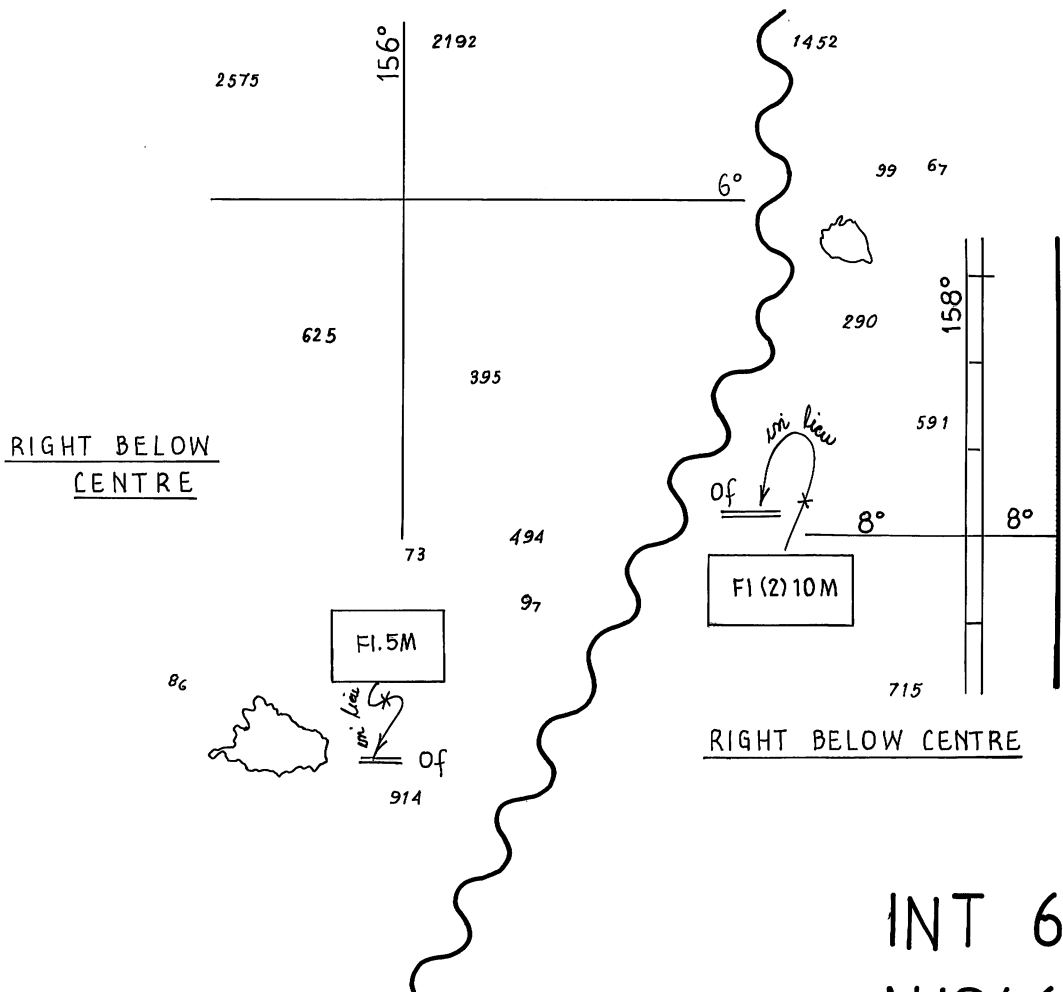

32/2010

433/2010

© Commonwealth of Australia 2010

INT 622

AUS4622