

LEFT BELOW CENTRE

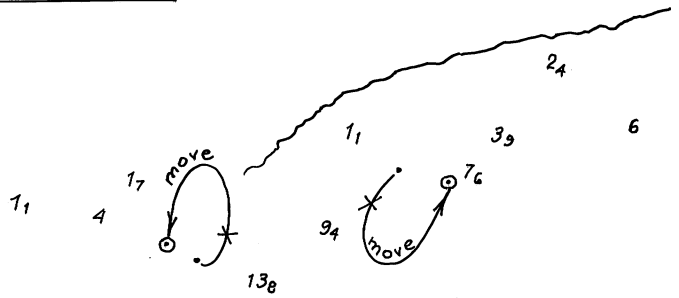

471/2010

946/2010

© Commonwealth of Australia 2010

AUS 201

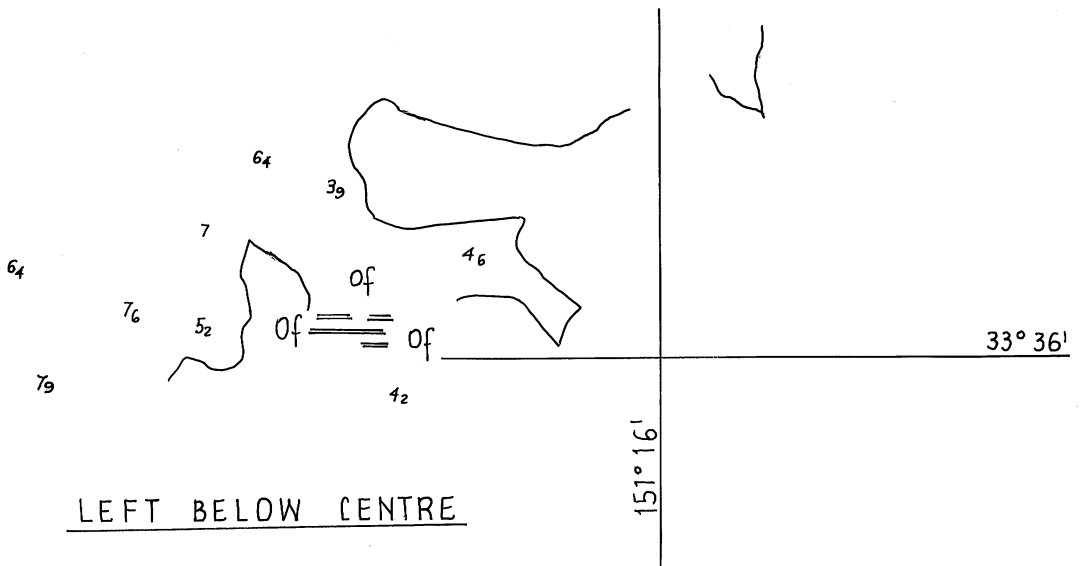

1351/2009

947/2010

© Commonwealth of Australia 2010

AUS 204

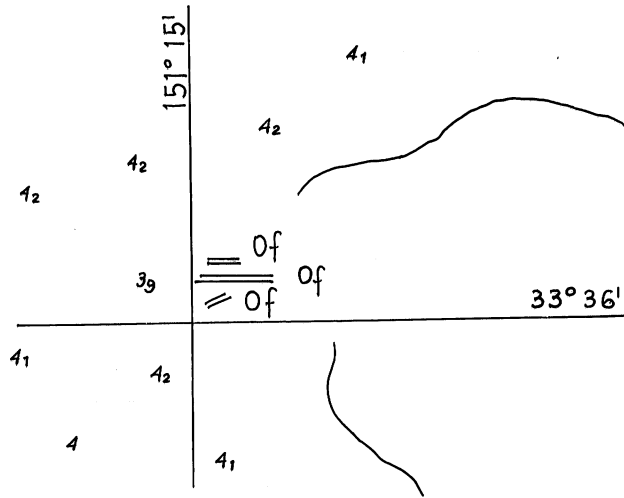

RIGHT BELOW CENTRE

1307/2009

947/2010

© Commonwealth of Australia 2010

AUS 217

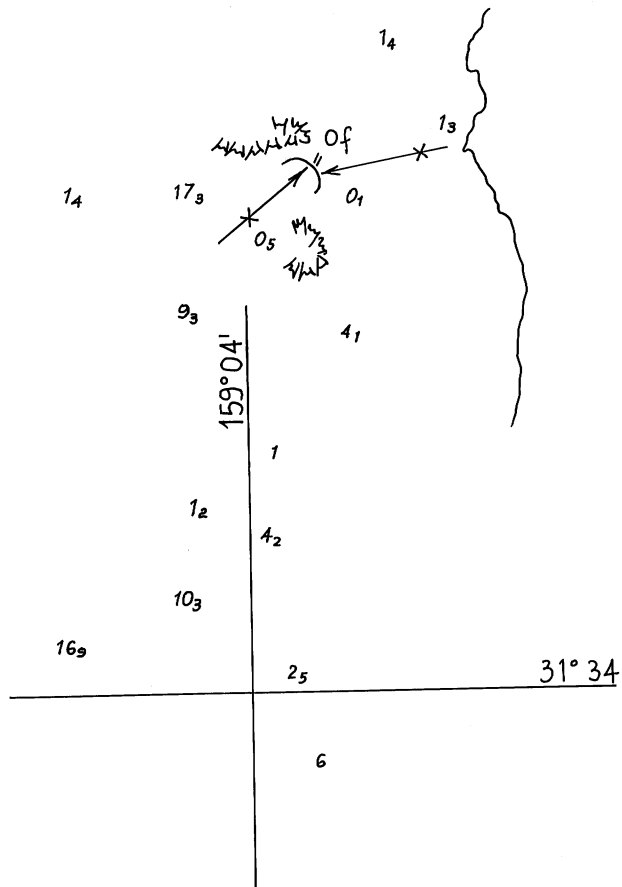

PLAN:
LORD HOWE ISLAND

896/2010

948/2010

© Commonwealth of Australia 2010

AUS 610

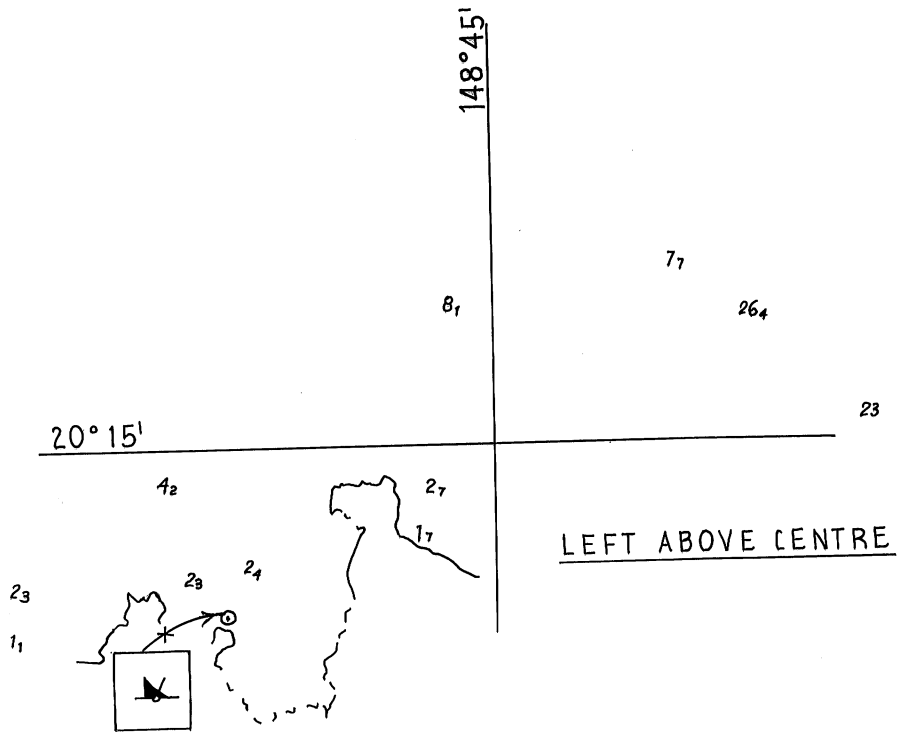

31/2010

949/2010

© Commonwealth of Australia 2010

AUS 252

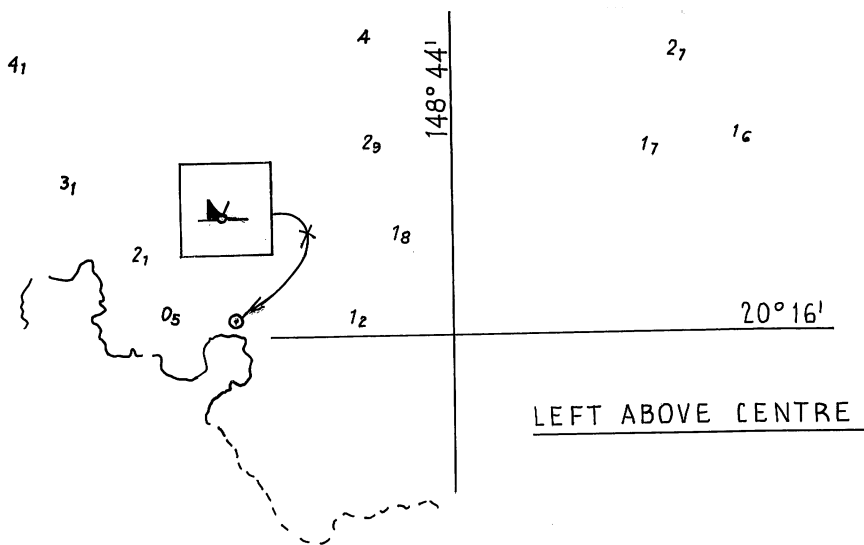

782/2010

949/2010

© Commonwealth of Australia 2010

AUS 253

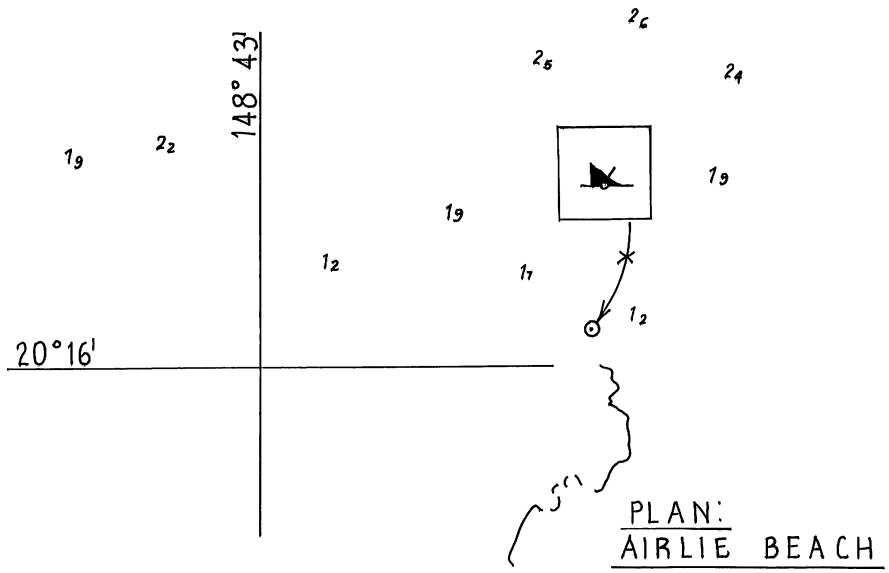

901/2010

949/2010

© Commonwealth of Australia 2010

AUS 268

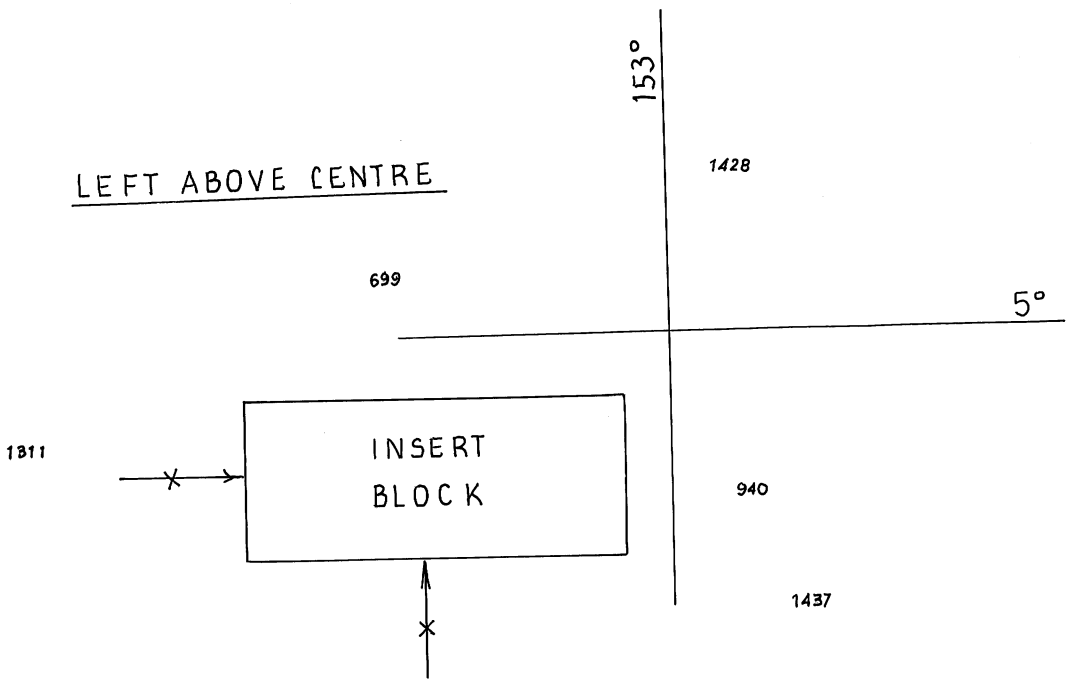

732/2008

950/2010

© Commonwealth of Australia 2010

AUS 397

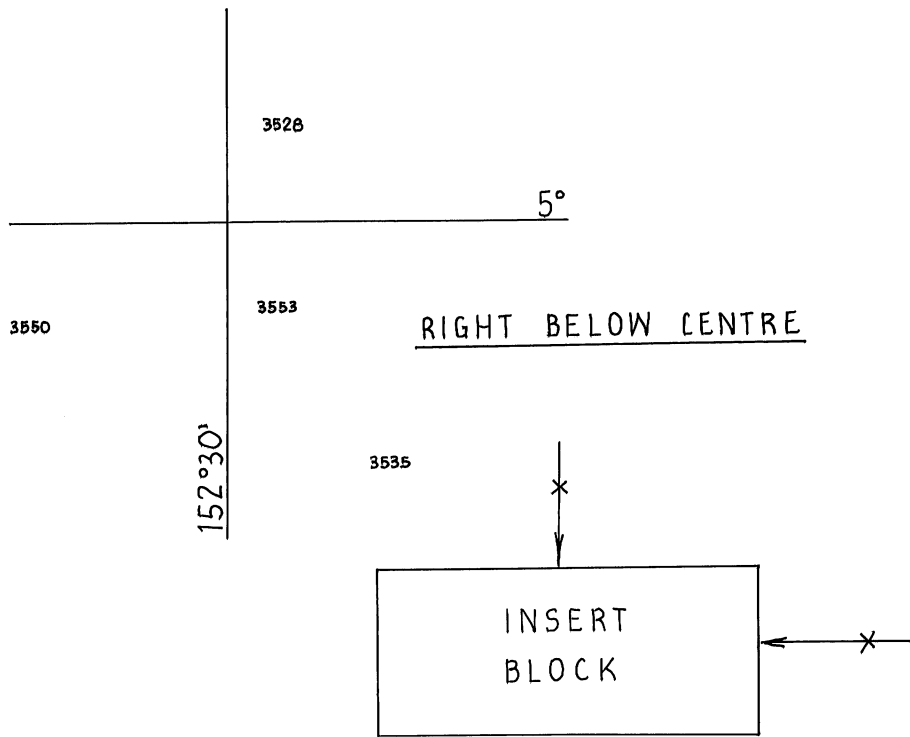

414/2010

950/2010

© Commonwealth of Australia 2010

AUS 554

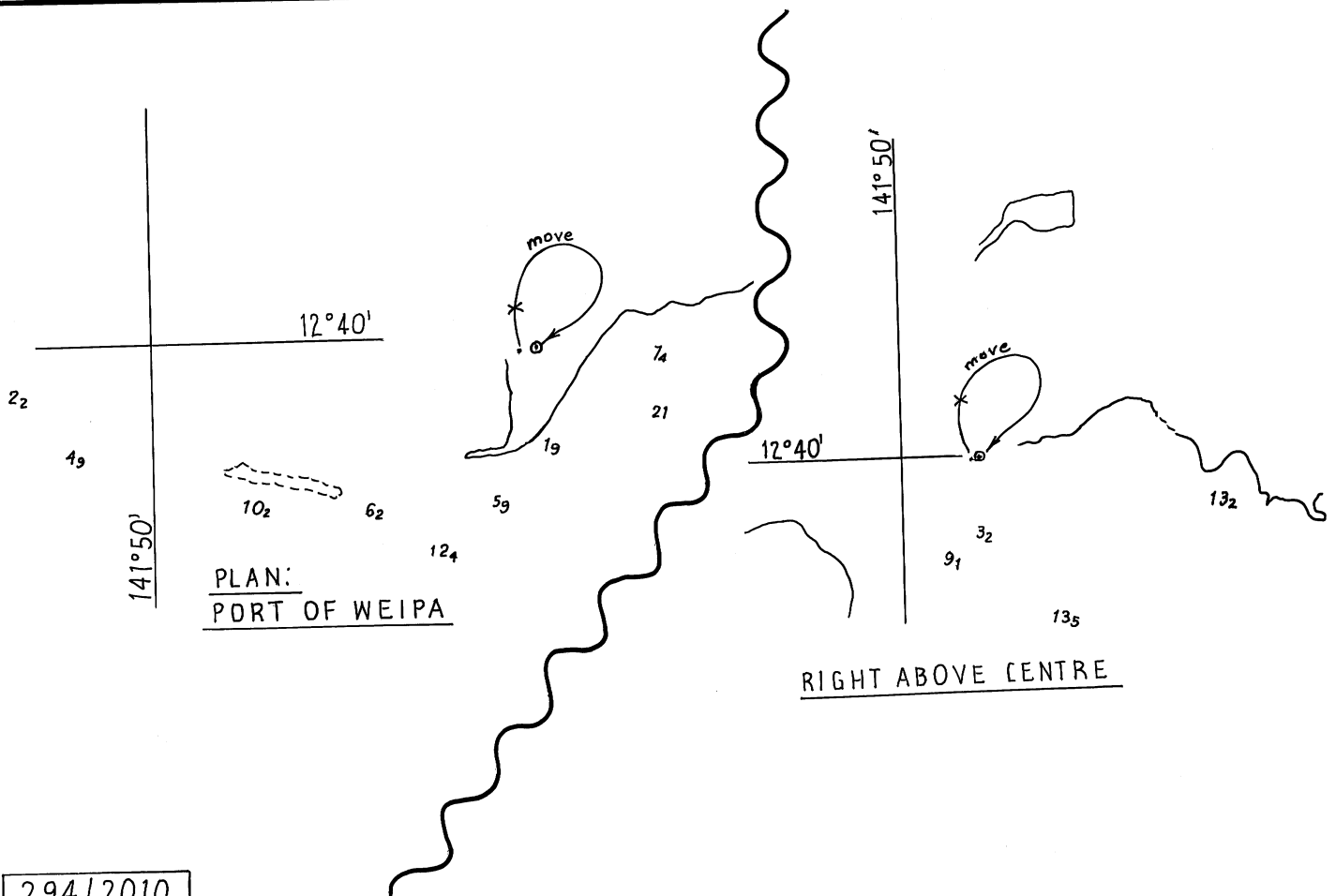

294/2010

952/2010

© Commonwealth of Australia 2010

AUS

4

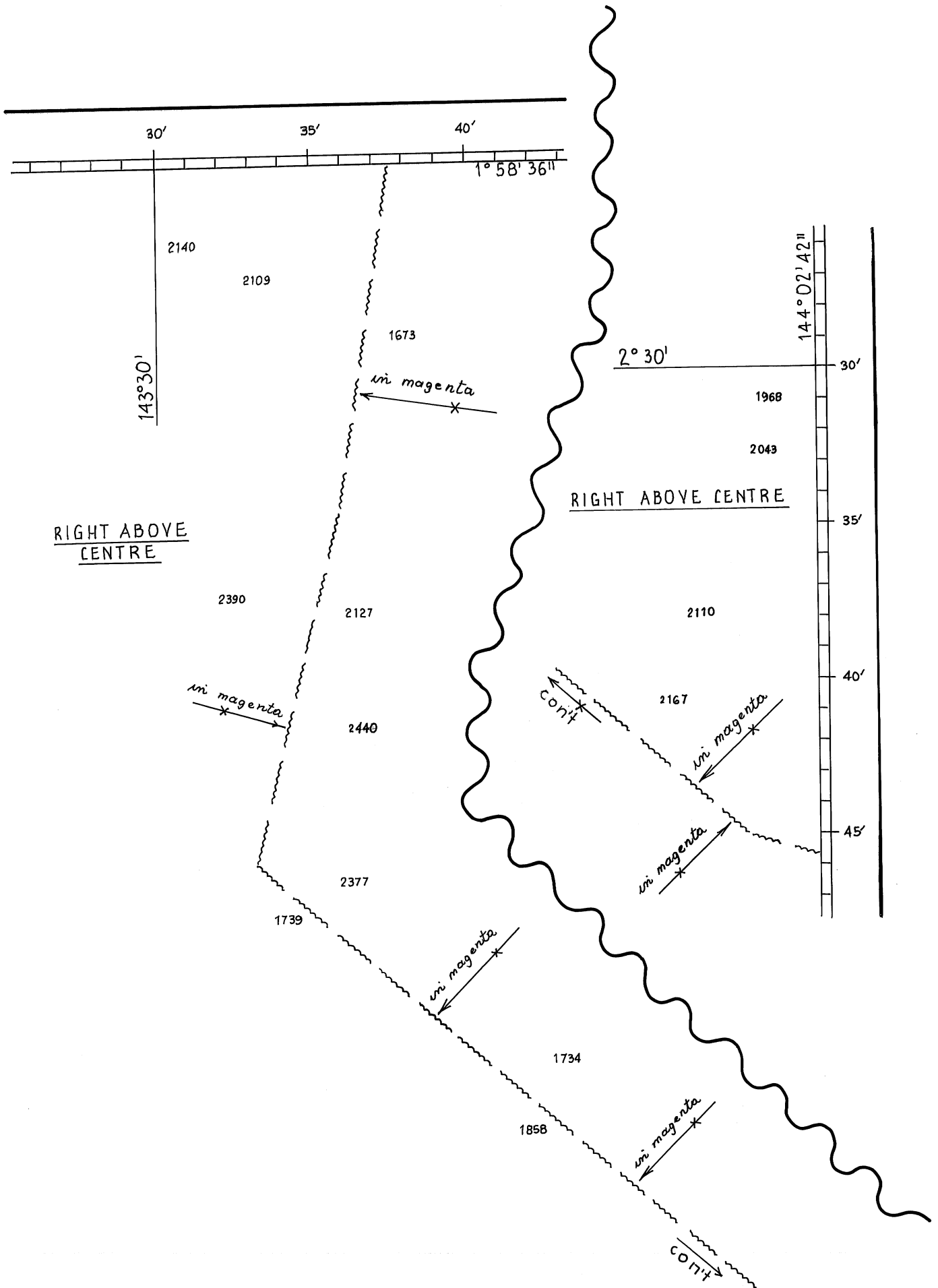

944/2009

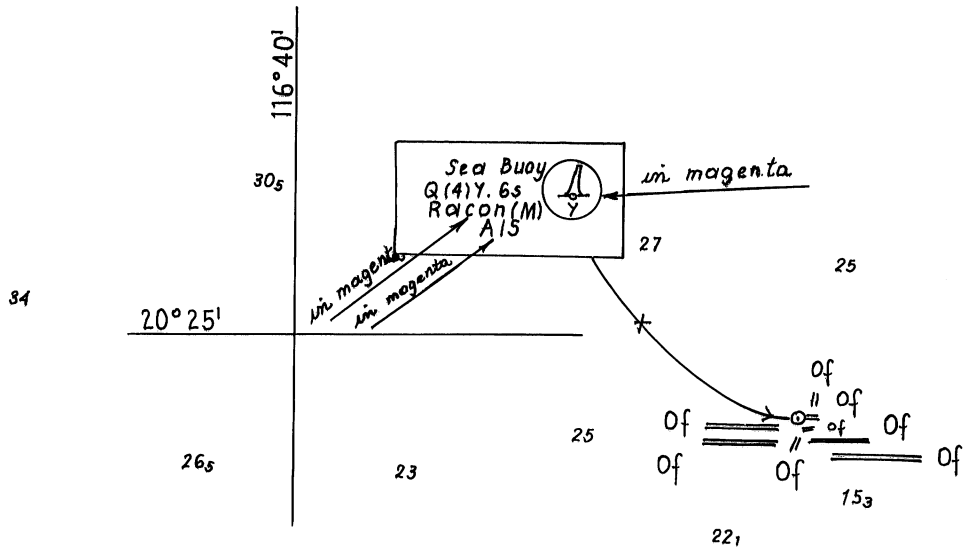

LEFT ABOVE CENTRE

596/2010

953/2010

© Commonwealth of Australia 2010

AUS 57

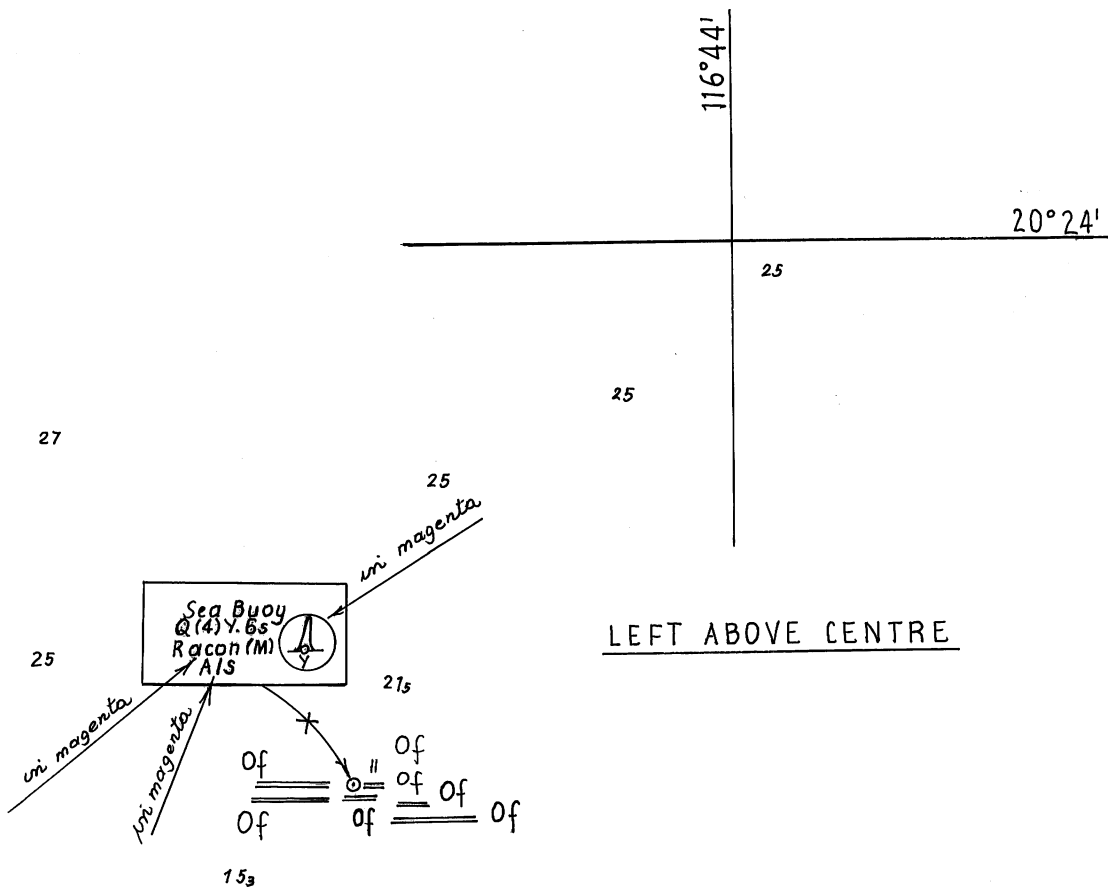

LEFT ABOVE CENTRE

363/2010

953/2010

© Commonwealth of Australia 2010

AUS 58

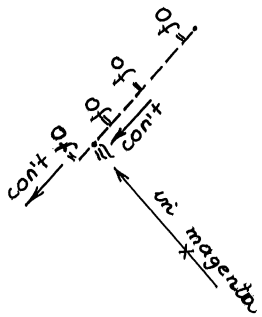

32

115°

31

38

39

30°45'

RIGHT BELOW CENTRE

32

38

34

35

PAGE 2 OF 2

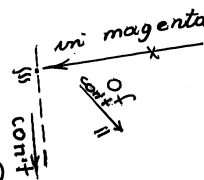

484/2010

954/2010

© Commonwealth of Australia 2010

AUS 753

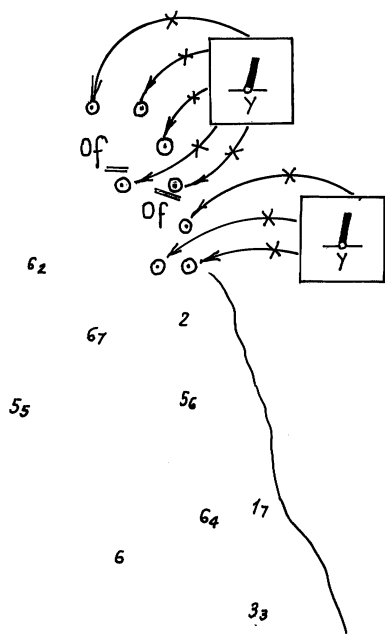

115°45'

RIGHT BELOW CENTRE

17

53

33

104

93

115°45'

31°45'



RIGHT BELOW CENTRE

31°45'

62

7

41

26

26

4c

33

56

597/2010

955/2010

© Commonwealth of Australia 2010

AUS 754

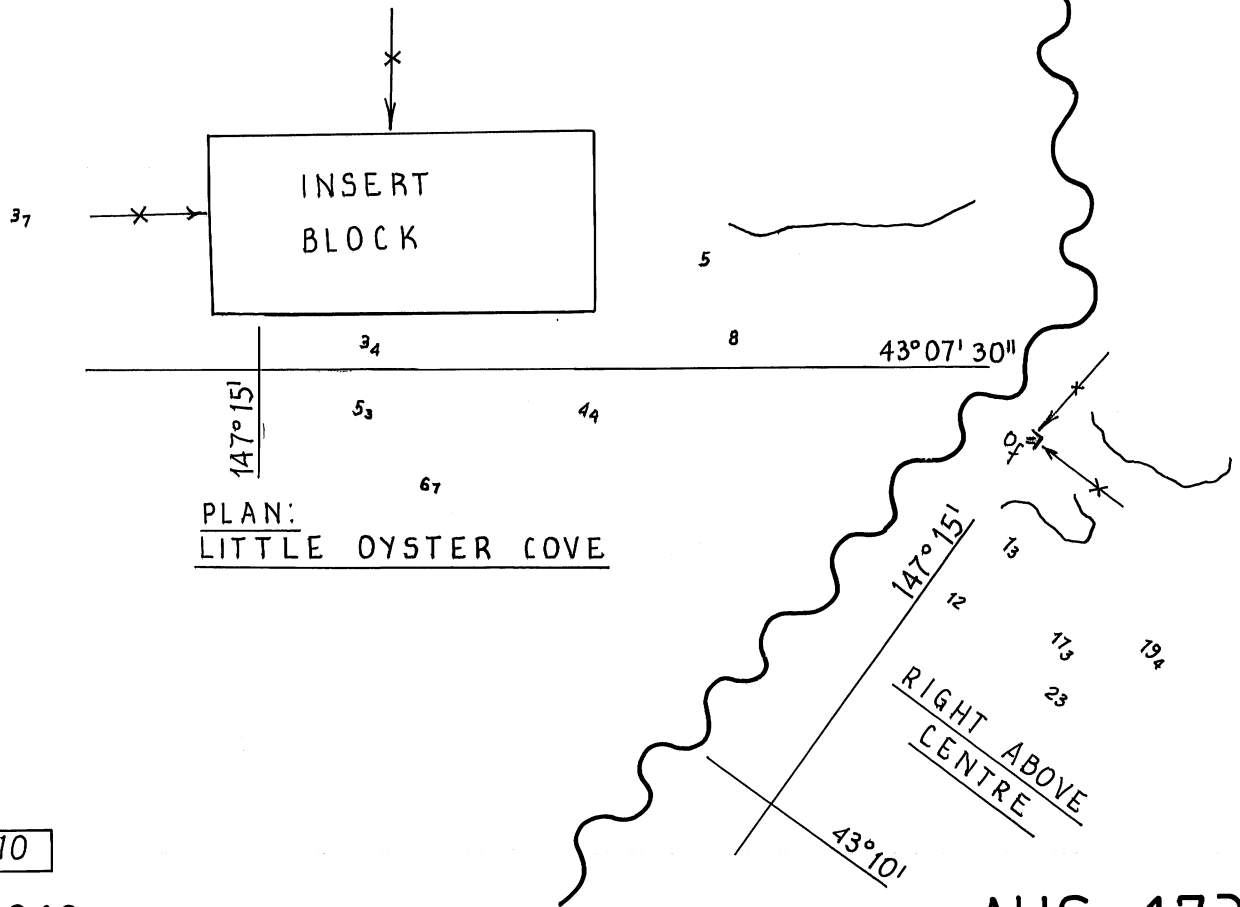

749/2010

956/2010

© Commonwealth of Australia 2010

AUS 173

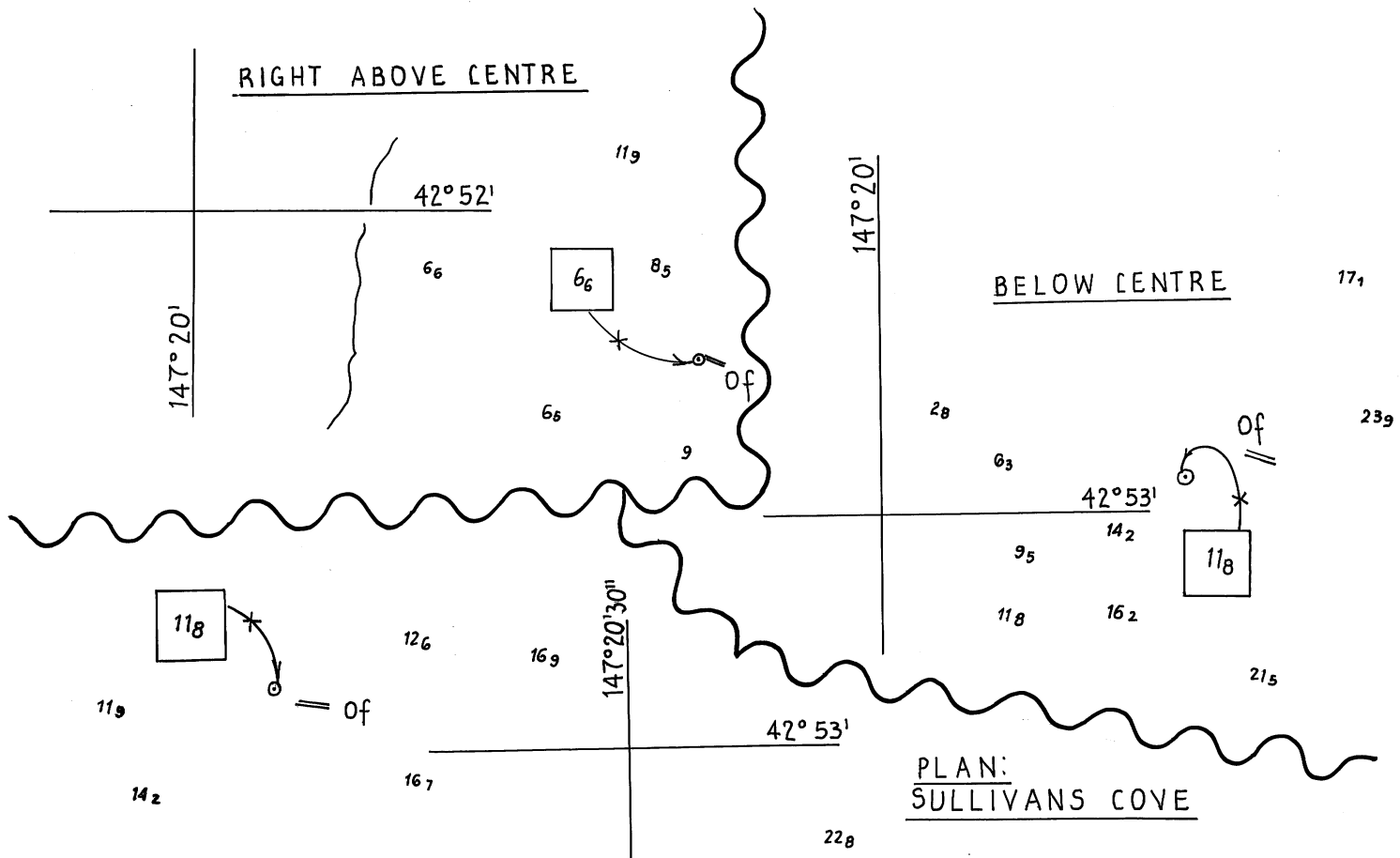

551/2010

957/2010

© Commonwealth of Australia 2010

AUS 172

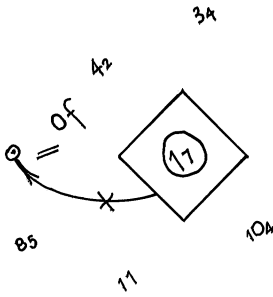

LEFT BELOW
CENTRE

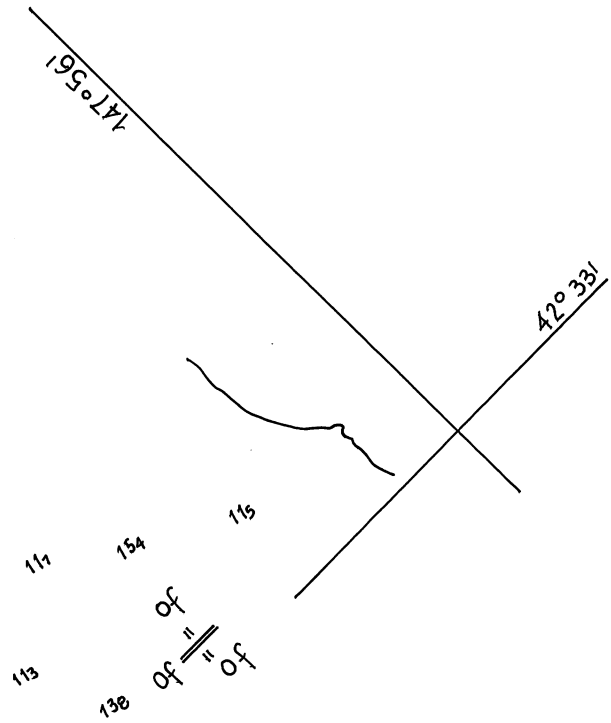

1138/2008

958/2010

© Commonwealth of Australia 2010

AUS 175

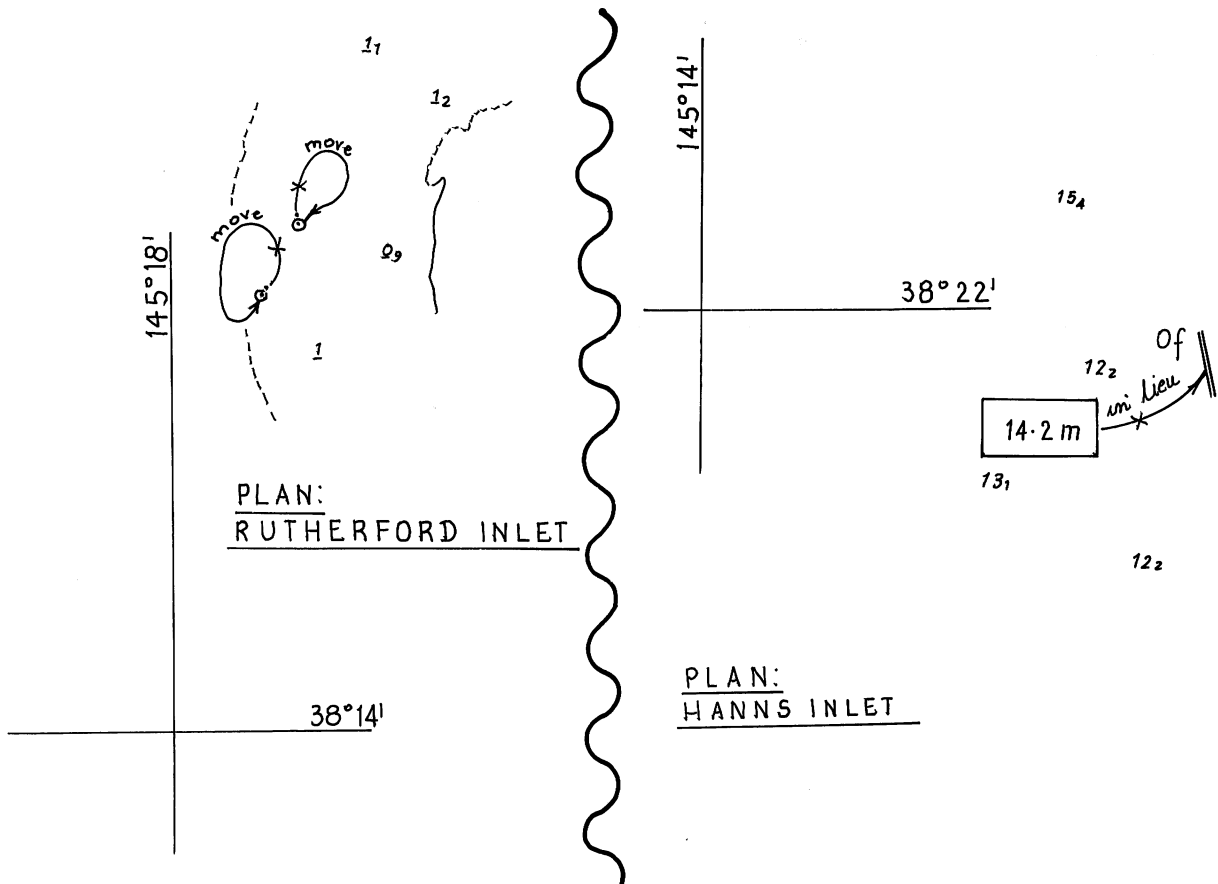

NE 4-6-2010

PAGE 1 OF 2

959960/2010

© Commonwealth of Australia 2010

AUS 152

PLAN:
HASTINGS BIGHT

PLAN:
CRIB POINT OIL
TERMINAL JETTY

PLAN:
HASTINGS BIGHT

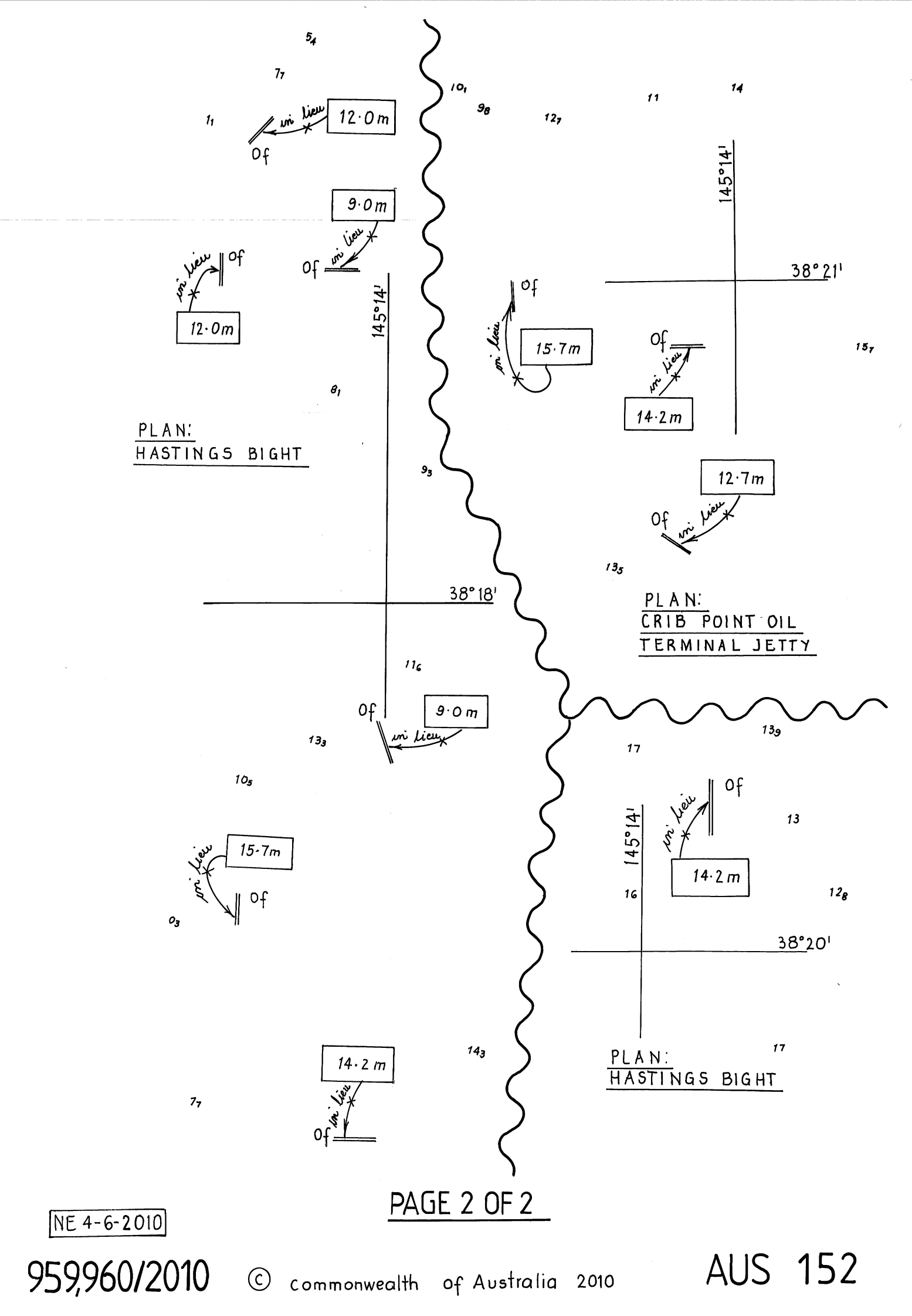

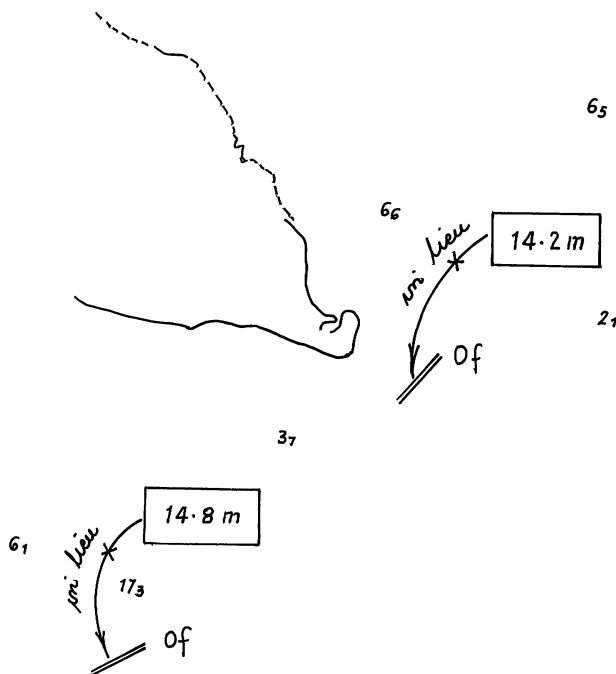
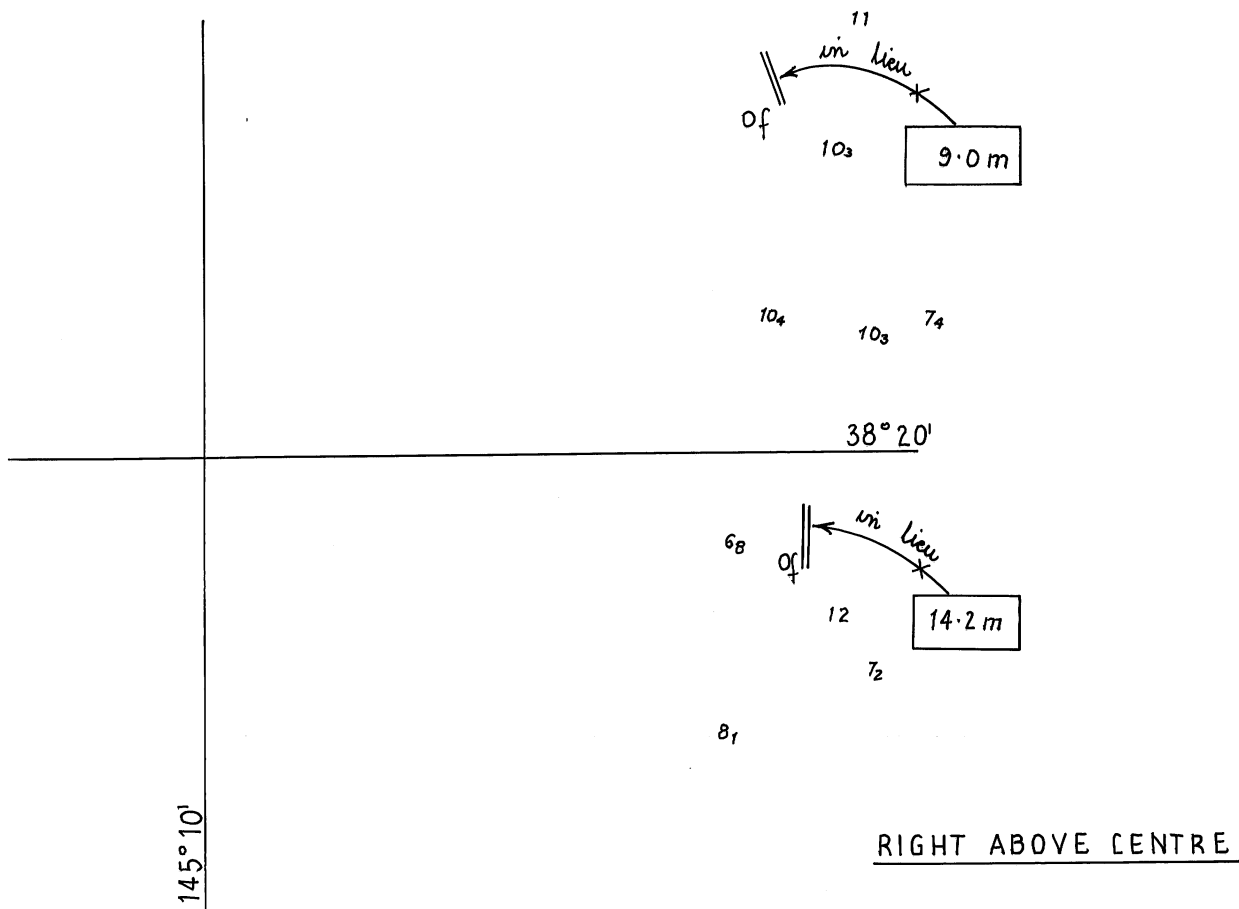

846/2010

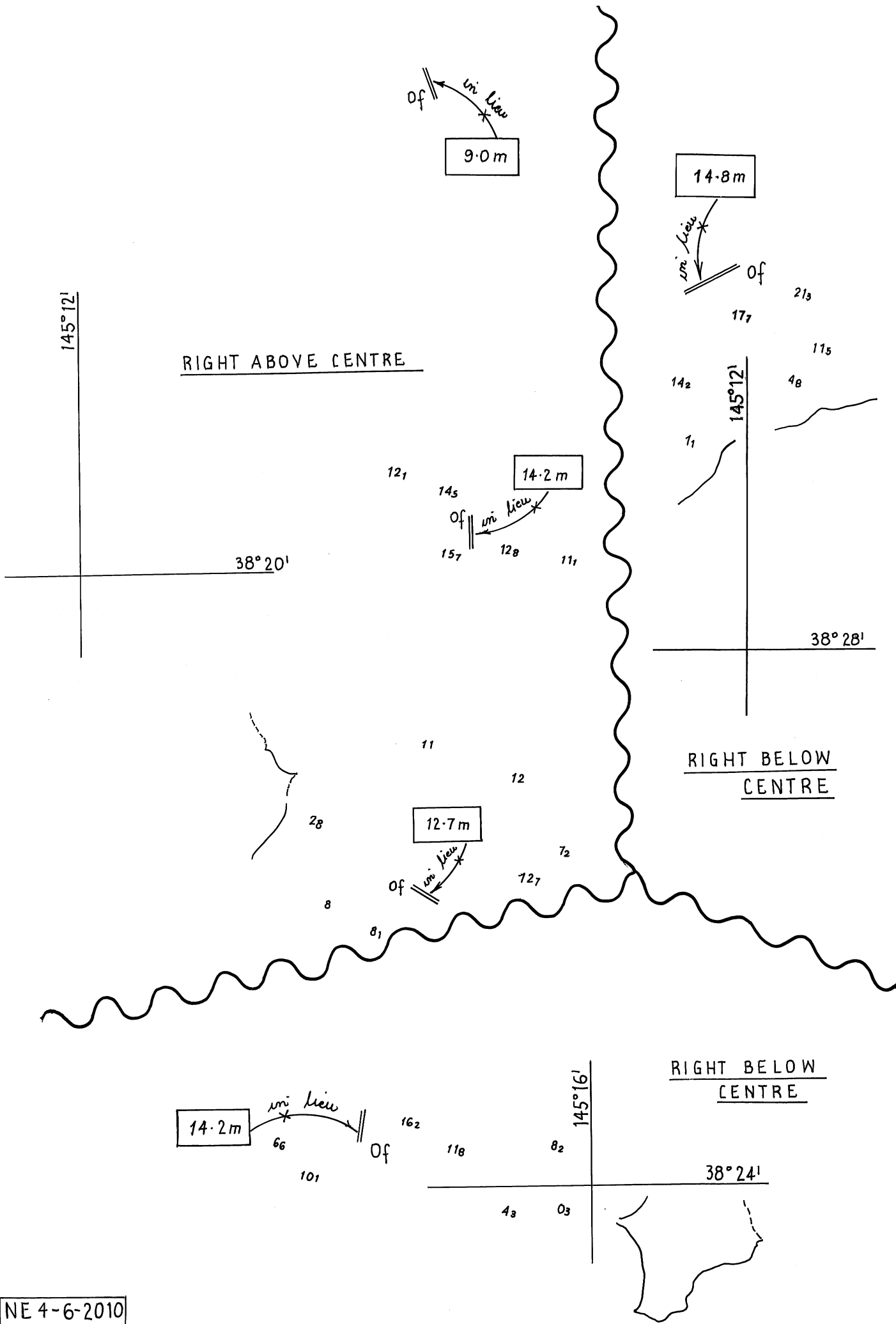

NE 4-6-2010

959/2010

© Commonwealth of Australia 2010

AUS 151

PLAN:
MILNER BAY

AMENDED TRACING

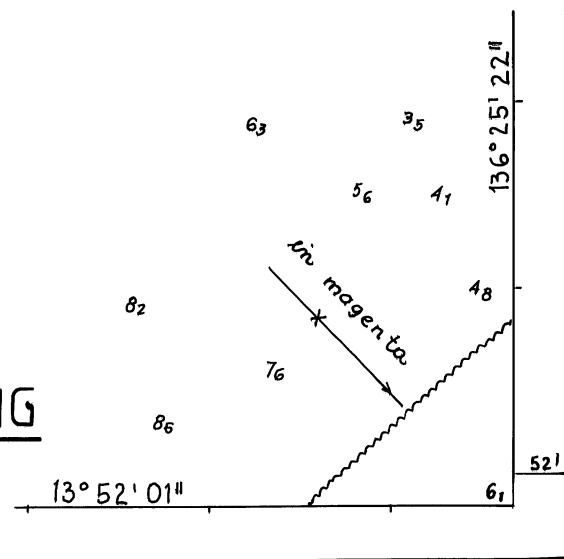

244/2009

905/2010

© Commonwealth of Australia 2010

AUS 14

LEFT BELOW CENTRE

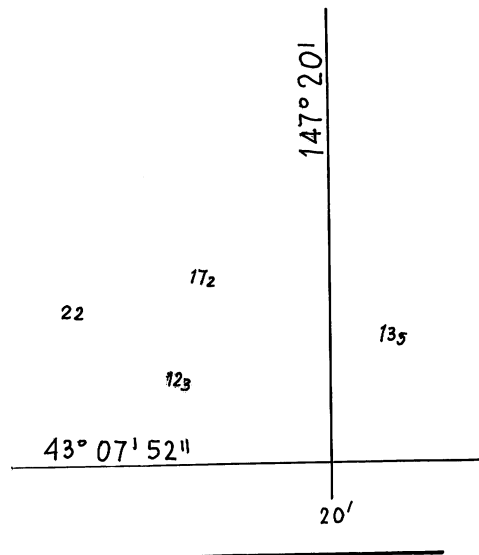
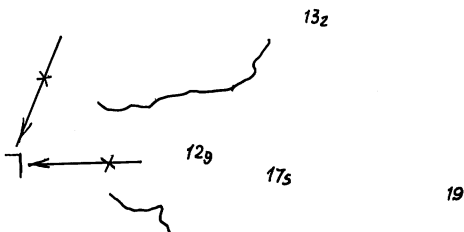

749/2010

956/2010

© Commonwealth of Australia 2010

AUS 171