

156/2010

253/2010

© Commonwealth of Australia 2010

AUS 22

15° 16'

128° 04'

PLAN:
APPROACHES
TO
WYNDHAM WHARF

★ Q (3) G. 4 s 8 m 3M

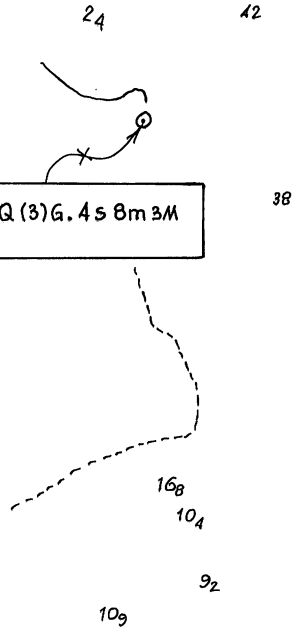

□ F1 (2) R. 4 s 3M
★ No 2
R

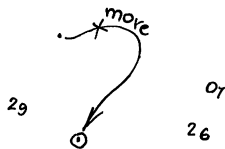
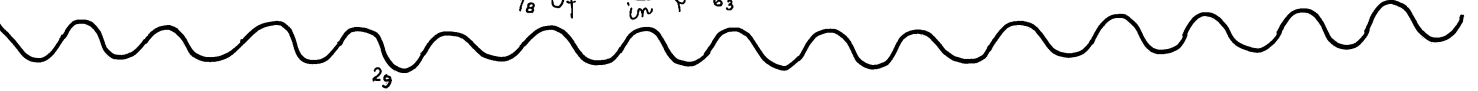
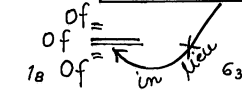

PLAN:
APPROACHES
TO
WYNDHAM WHARF

15° 20'

128° 08'

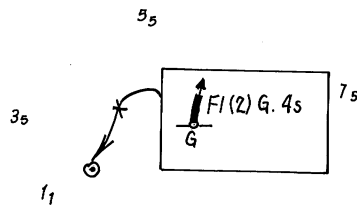

366/2009

255/2010

© Commonwealth of Australia 2010

AUS 32

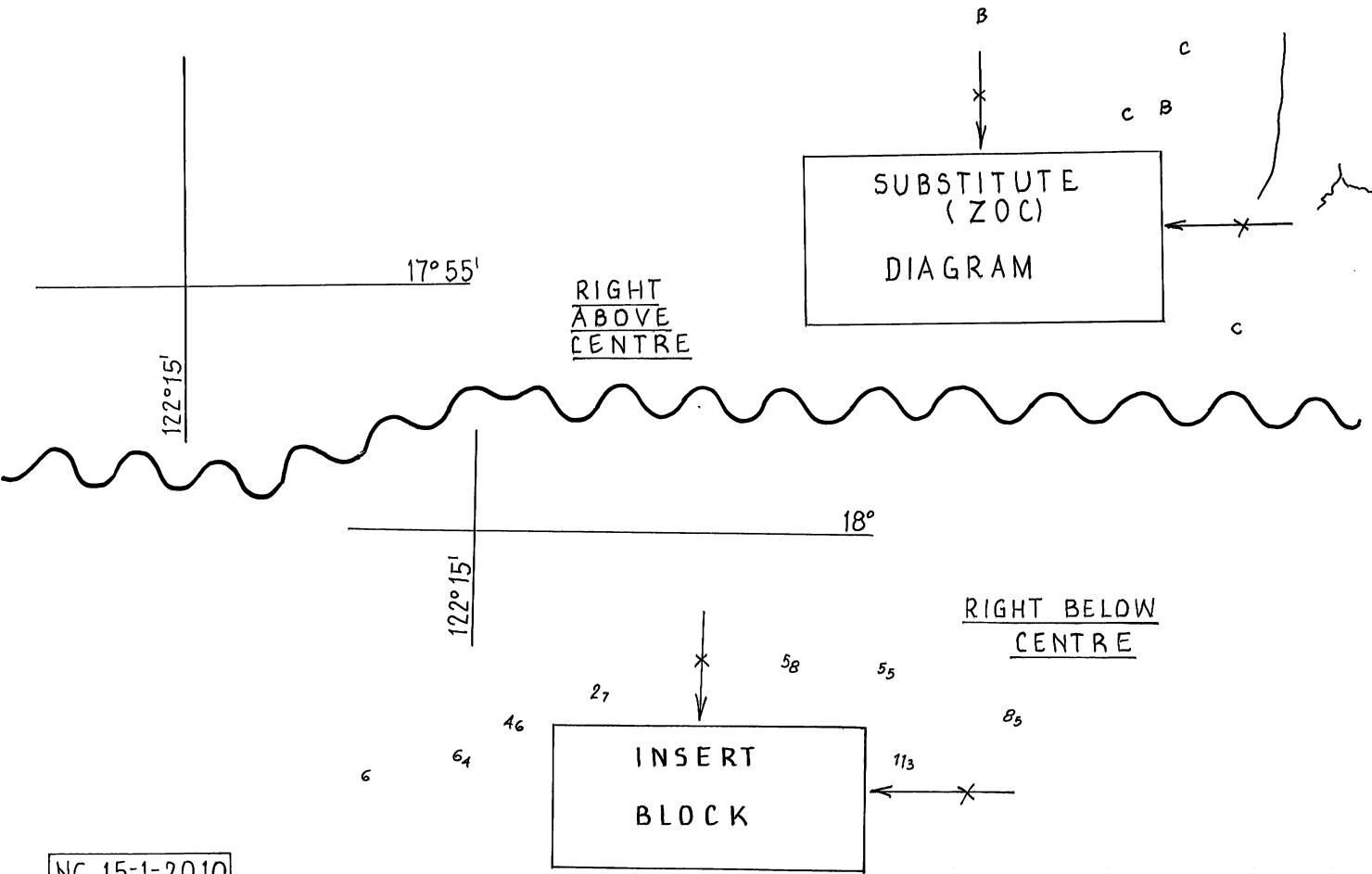

NC 15-1-2010

PLAN:
SLOPE ISLAND

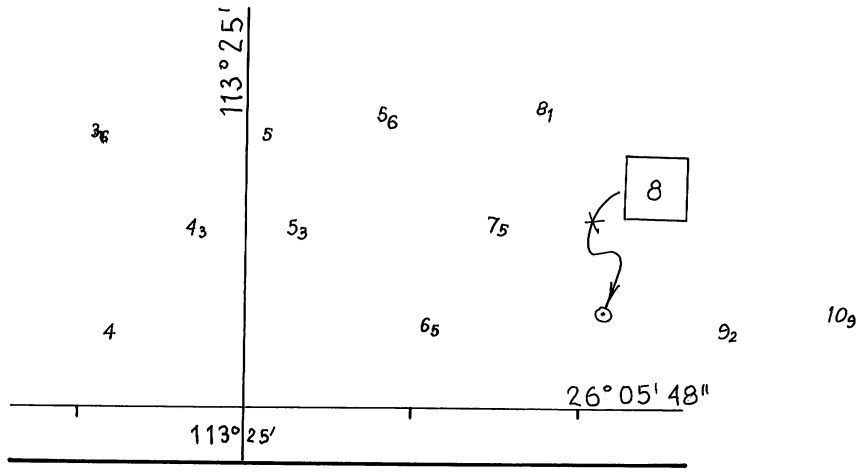

1427/2009

259/2010

© Commonwealth of Australia 2010

AUS 74

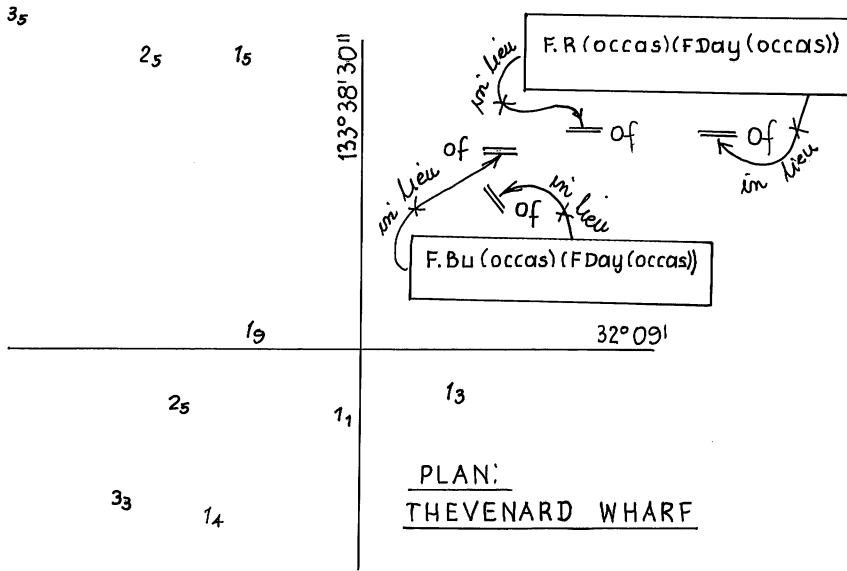

1273/2009

261/2010

© Commonwealth of Australia 2010

AUS 122

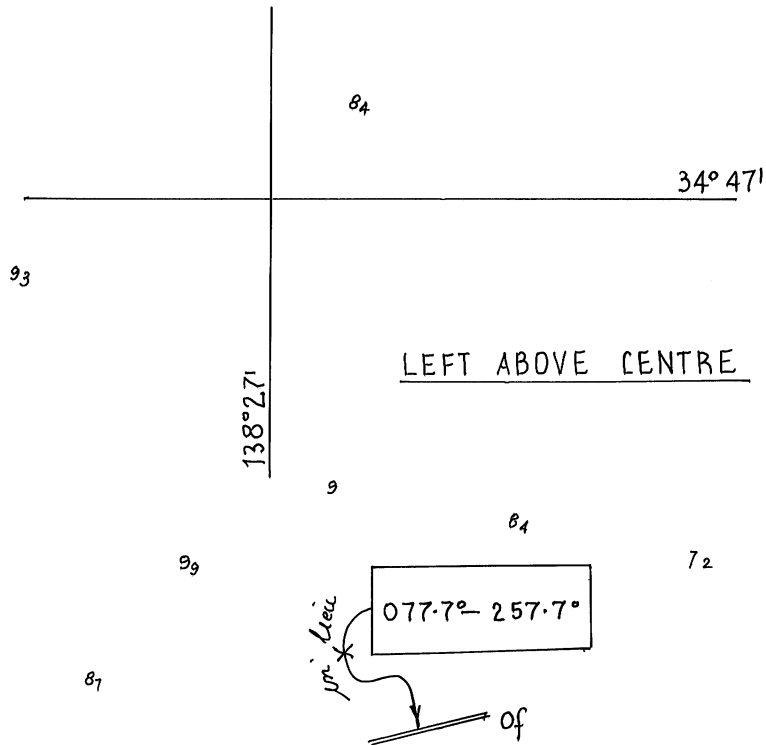

118/2010

264/2010

RIGHT OF CENTRE

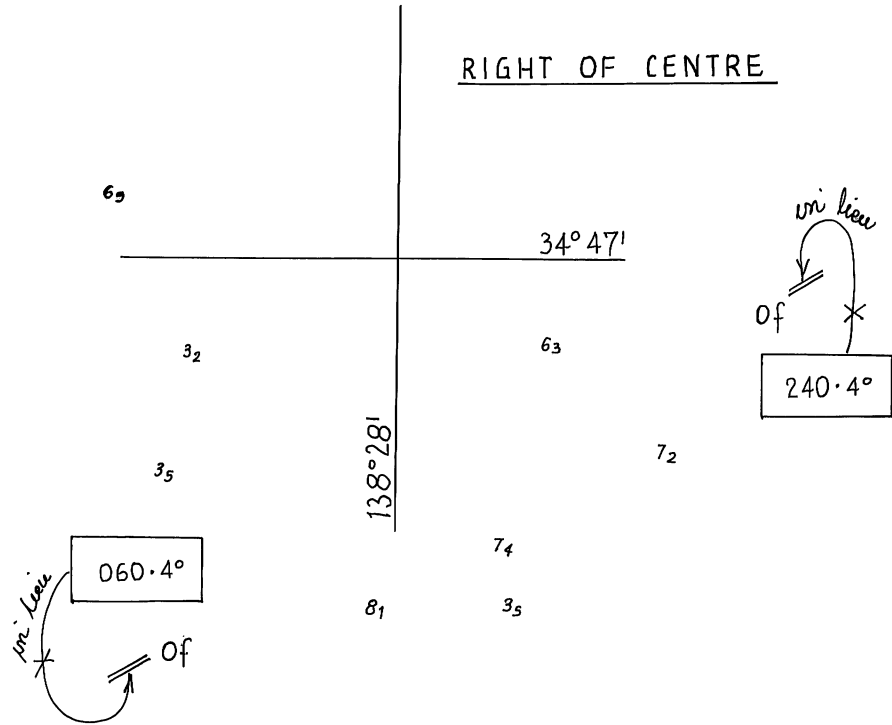

1365/2009

264/2010

© Commonwealth of Australia 2010

AUS 138

6₁

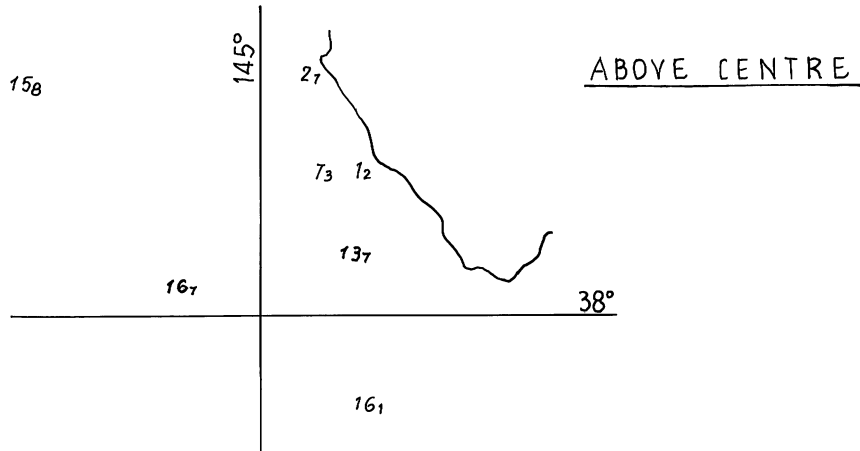
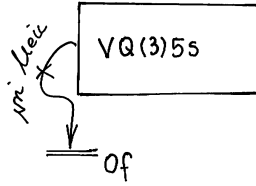

1370/2009

266/2010

© commonwealth of Australia 2010

AUS 143

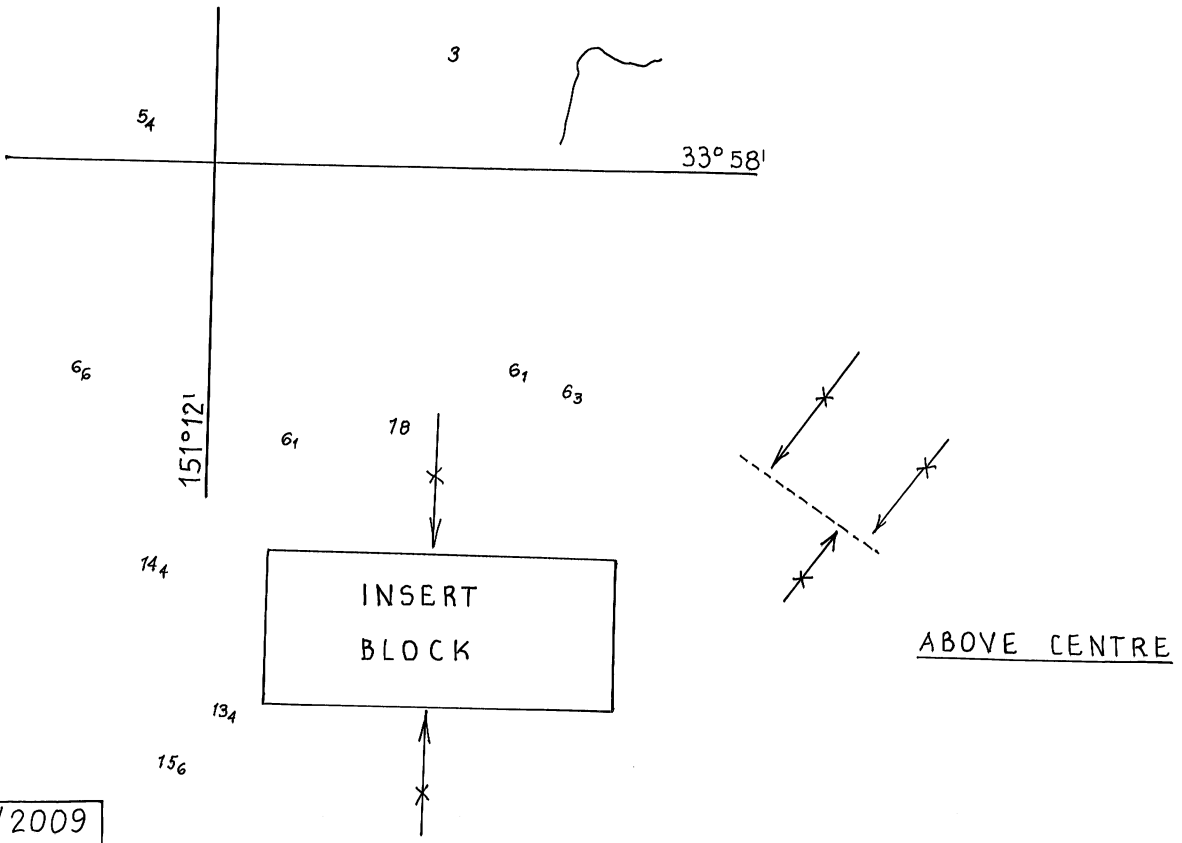

14/10/2009

24/1/2010

© Commonwealth of Australia 2010

AUS 199

146/2010

242/2010

© Commonwealth of Australia 2010

AUS 200

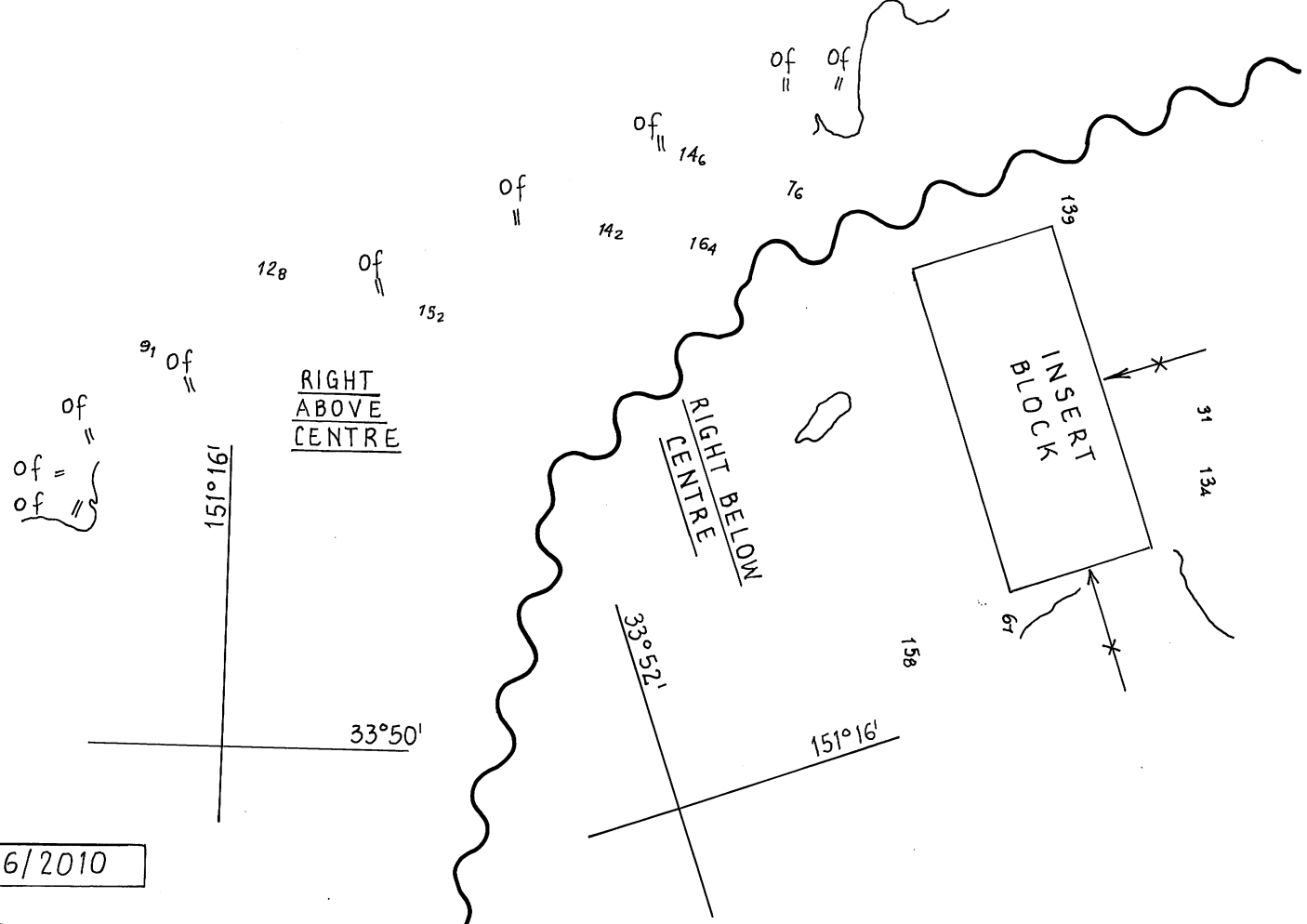

27
LEFT BELOW CENTRE

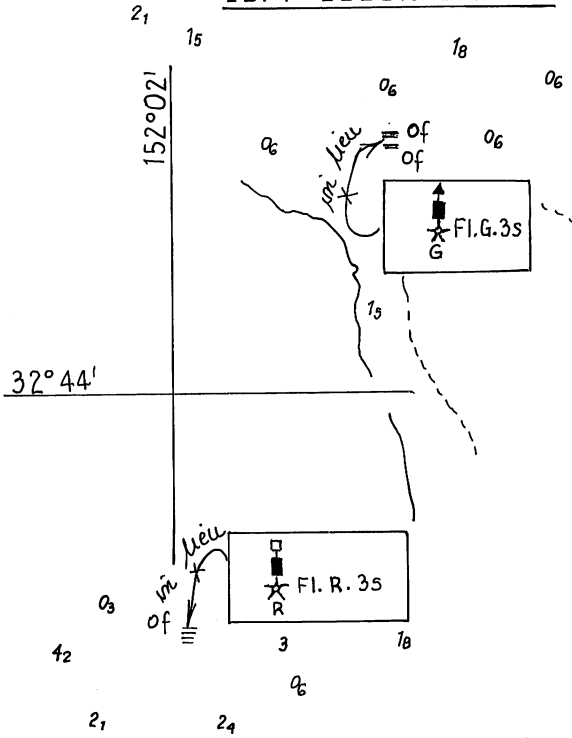

LEFT ABOVE CENTRE

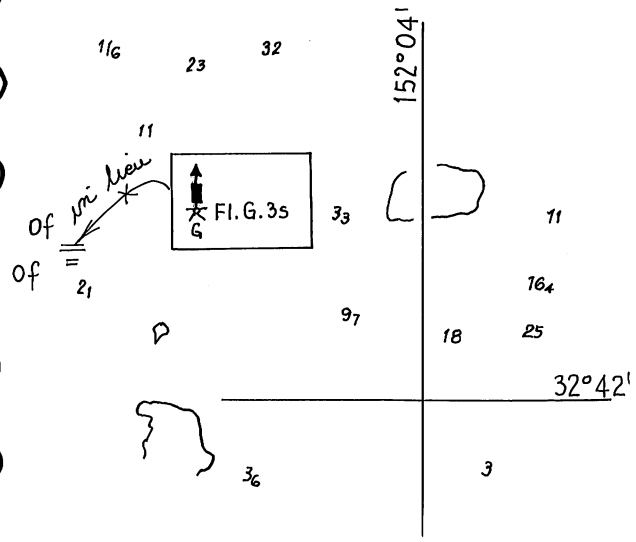

1351/2009

244/2010

AUS 209

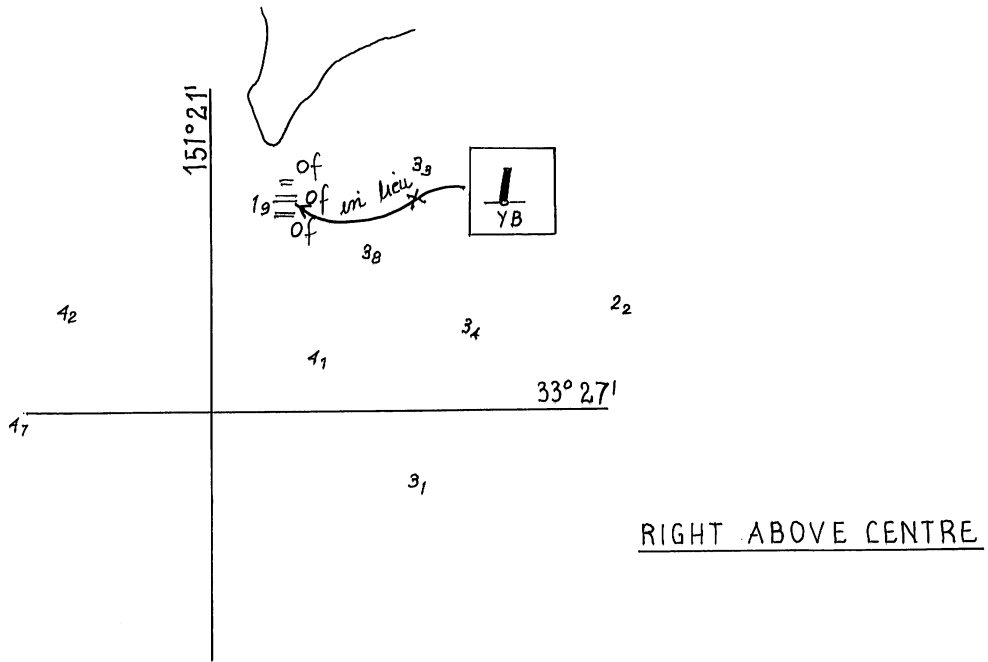

1351/2009

243/2010

© Commonwealth of Australia 2010

AUS 216

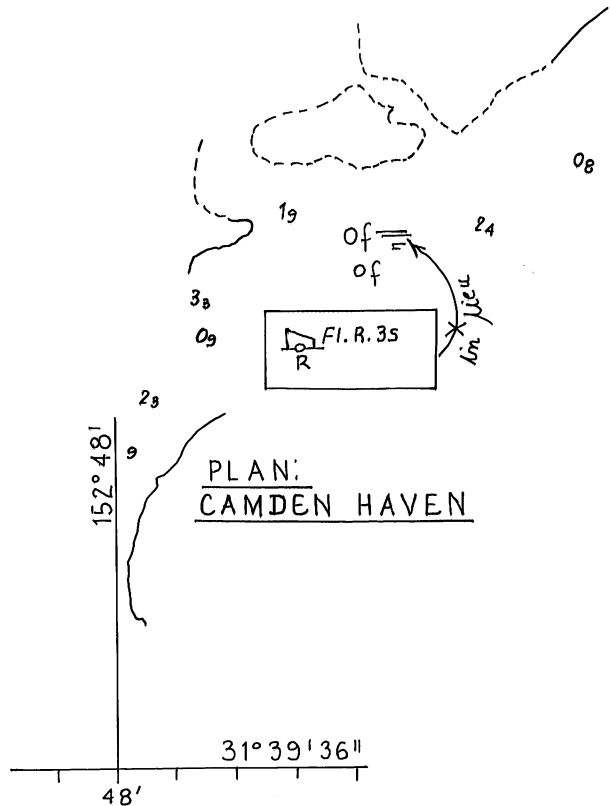
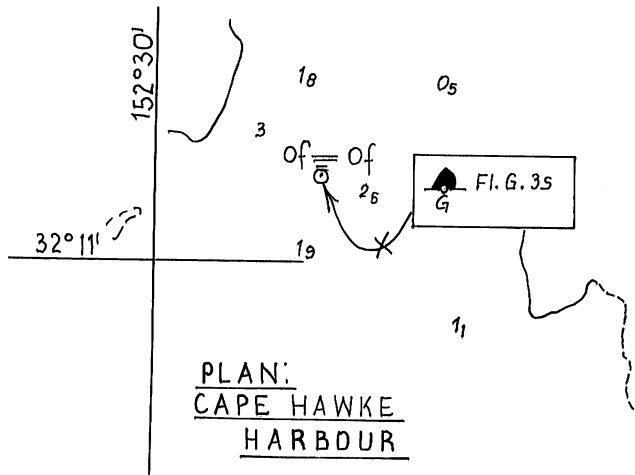

1259/2009

245,246/2010

© Commonwealth of Australia 2010

AUS 219

PLAN:
RICHMOND
RIVER
ENTRANCE

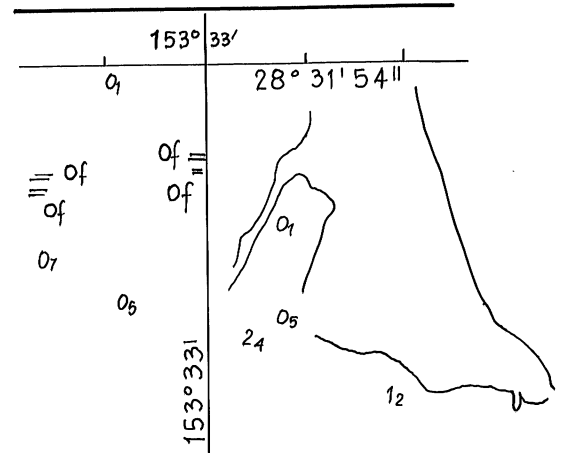
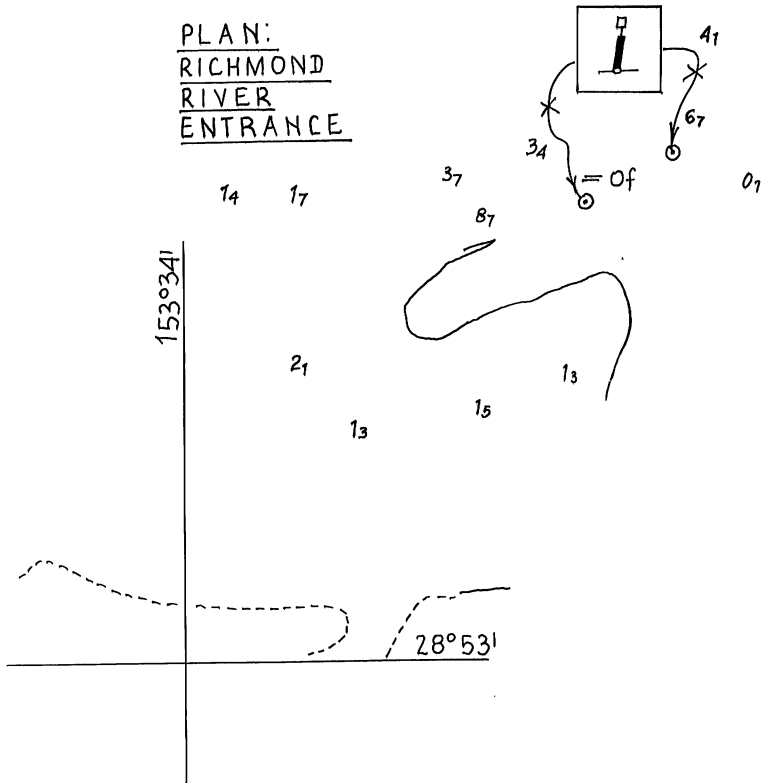

PLAN:
BRUNSWICK
RIVER ENTRANCE

147/2010

58

58

81

30°15'

62

BELOW CENTRE

71

ODAS

Mr. Lieu

80

Of

77

153°20'



91

ODAS

Mr. Lieu

100

Of

108

153°25'

97

108

30°15'

99

111

RIGHT BELOW CENTRE

1045/2009

247/2010

© Commonwealth of Australia 2010

AUS 221

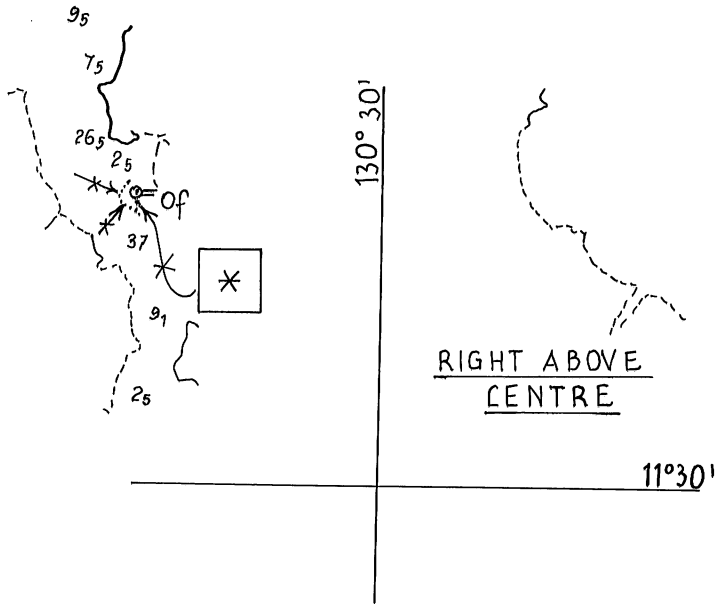

109/2010

253/2010

© Commonwealth of Australia 2010

AUS 309

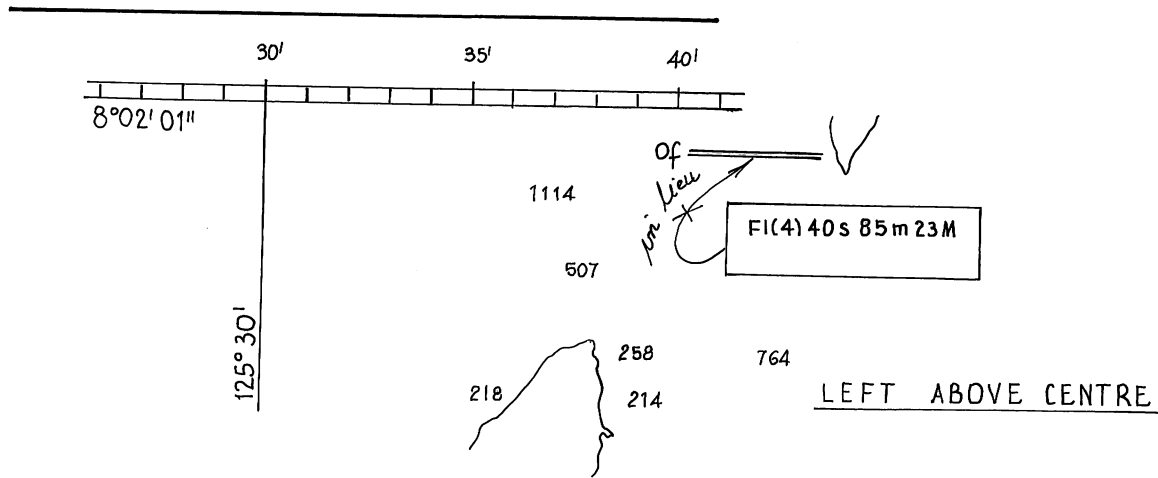

998/2009

254/2010

© Commonwealth of Australia 2010

AUS 313

LEFT BELOW CENTRE

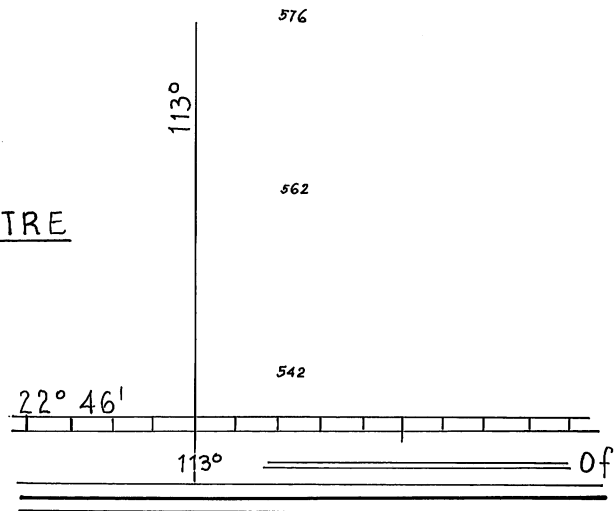

1364/2009

258/2010

© Commonwealth of Australia 2010

AUS 329

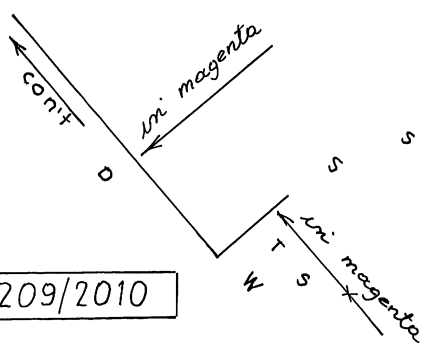
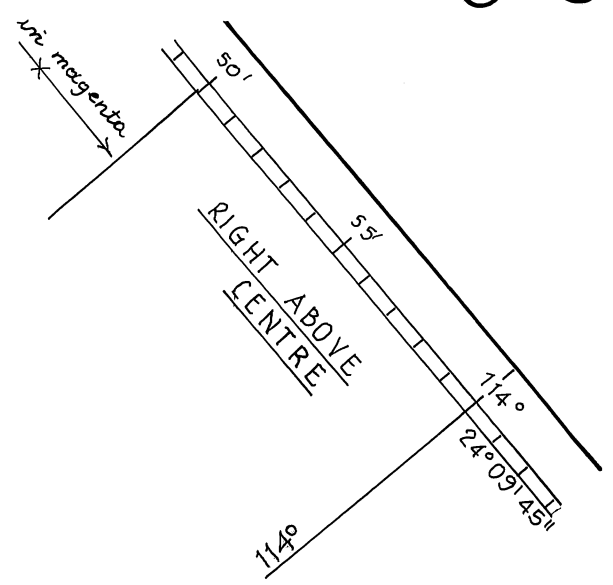
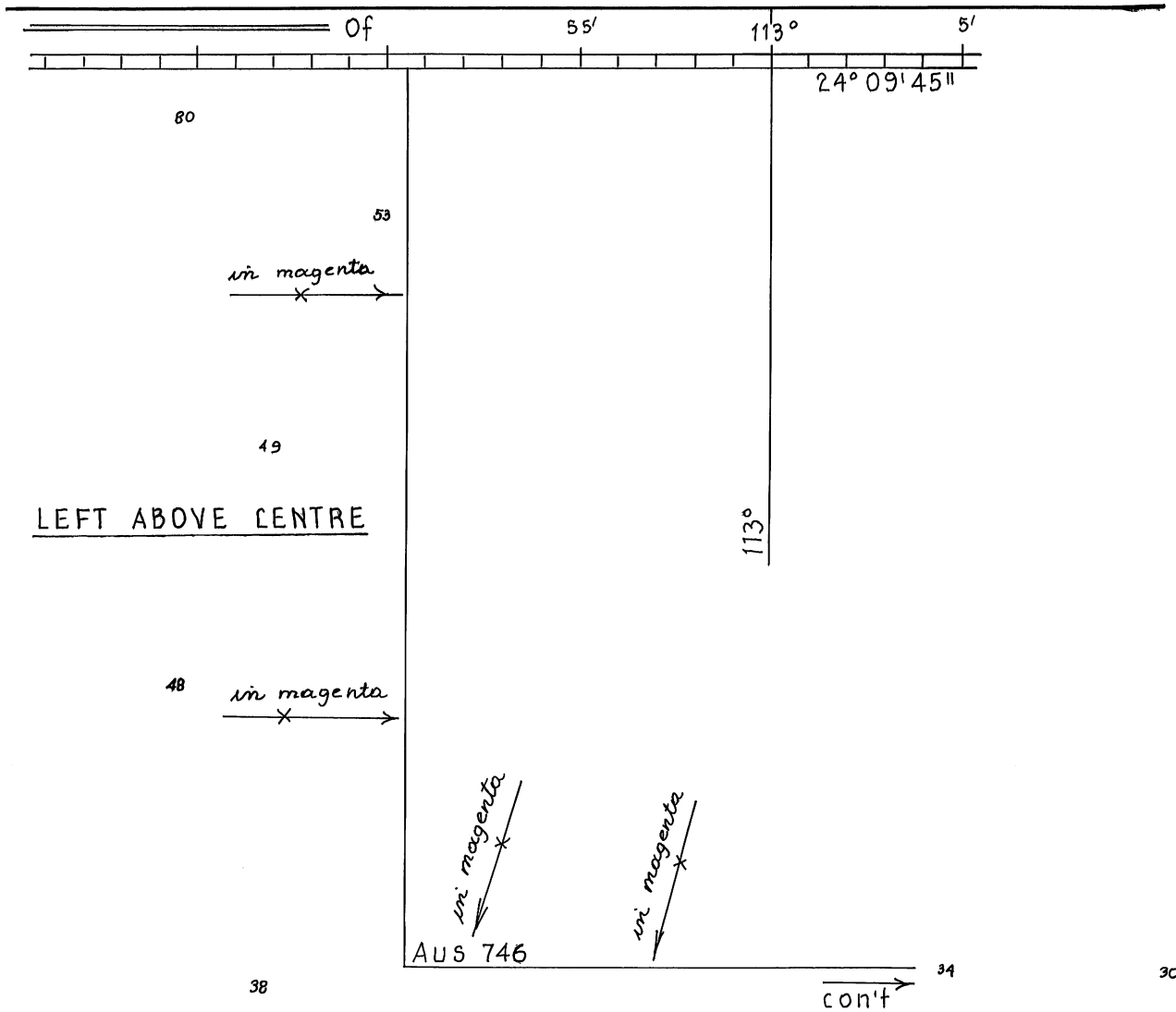

209/2010

258/2010

© Commonwealth of Australia 2010

AUS 331

35°

227

139

787

of

ODAS

31

RIGHT BELOW
CENTRE

35

42

257

151

RIGHT ABOVE CENTRE

36°17'07".7

150

31

136°30'

42

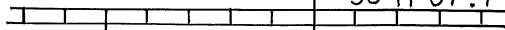

55'

136°



49

42

44

69

37

42

ODAS

37

31

46

35

of

42/2010

262/2010

© Commonwealth of Australia 2010

AUS 343

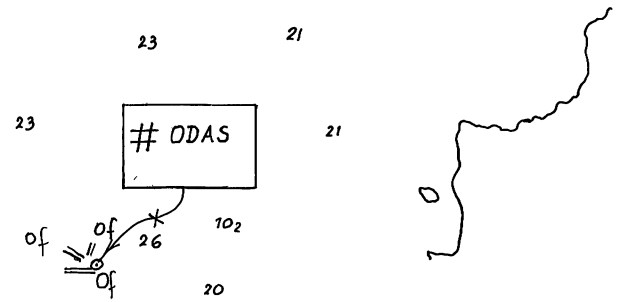
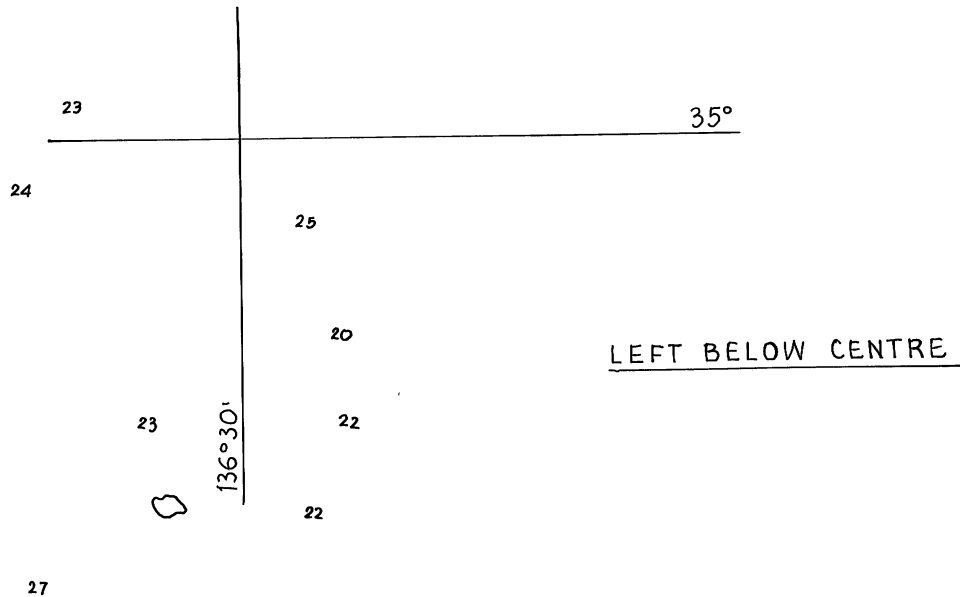

42/2010

262/2010

© Commonwealth of Australia 2010

AUS 345

LEFT ABOVE CENTRE

07

00

77

36°

02

06

76

08

91

136°

73

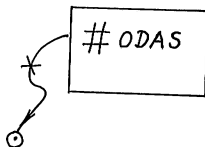

1240/2008

262/2010

© Commonwealth of Australia 2010

AUS 346

cont of
 $141^{\circ}30'$

of =
77

88

of =
21

115

of =

38°30'

86

of

RIGHT BELOW
CENTRE

of =

of =

of =

of =

RIGHT BELOW
CENTRE

431

of =
cont
 $141^{\circ}30'$

464

of =

882

of =

1407

of = of

of

$38^{\circ}53'48''$

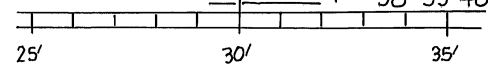

1082/2008

265/2010

© Commonwealth of Australia 2010

AUS 348

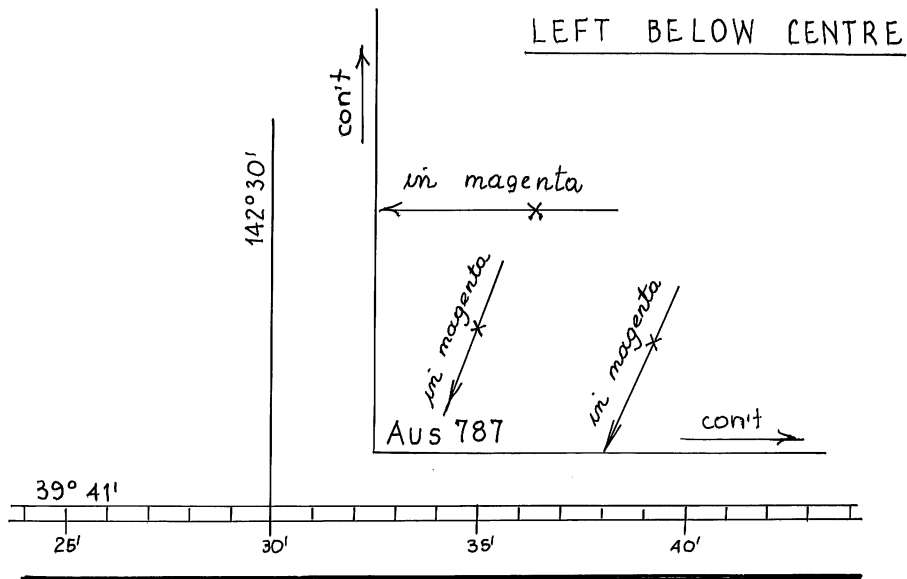

730

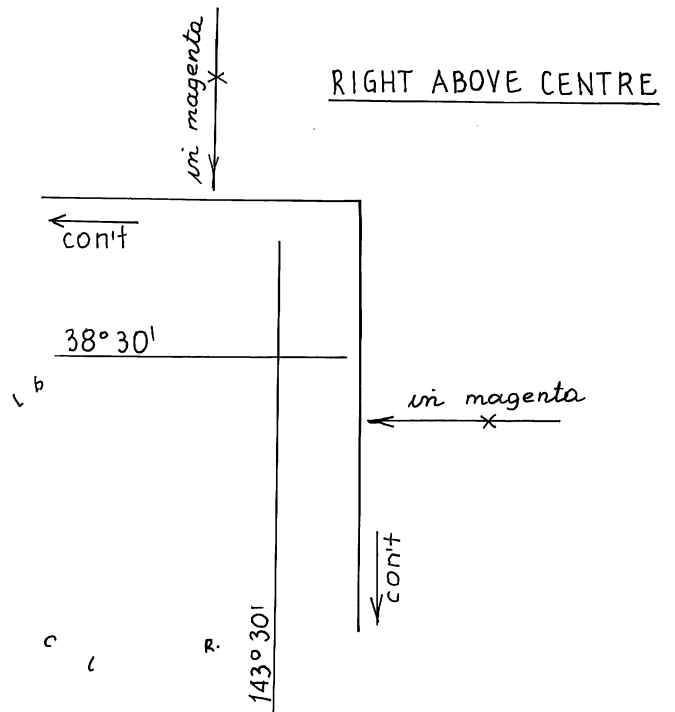
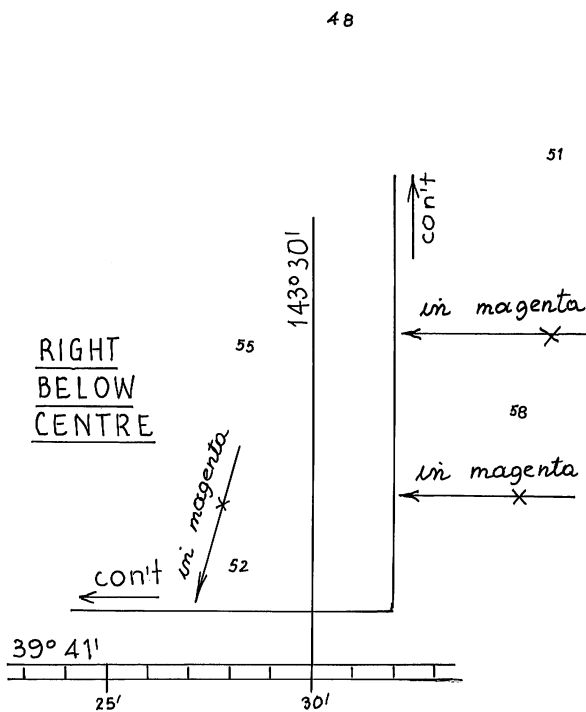

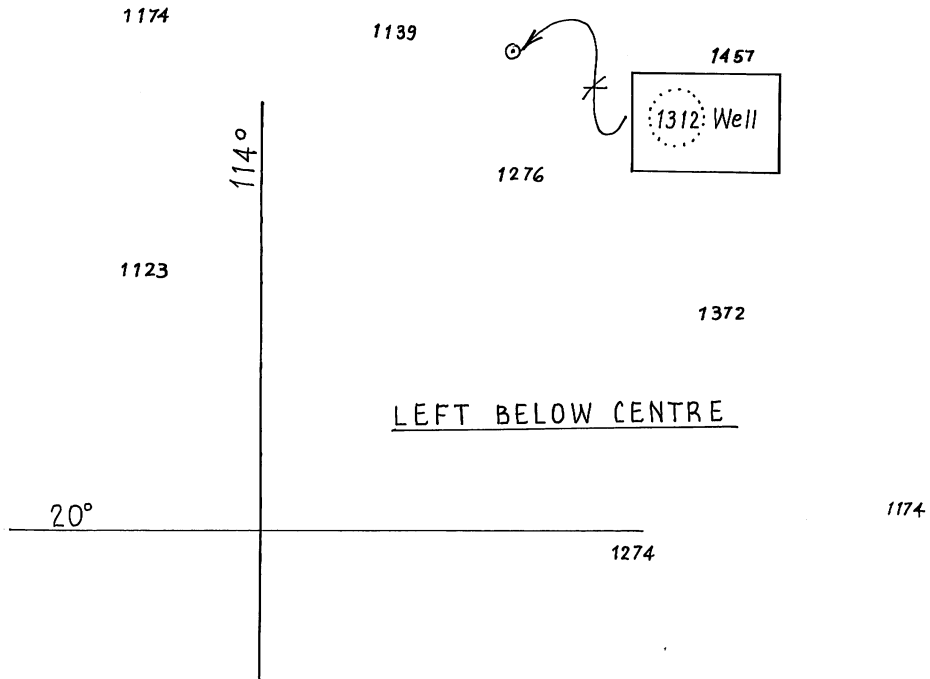

113/2010

257/2010

© commonwealth of Australia 2010

AUS 415

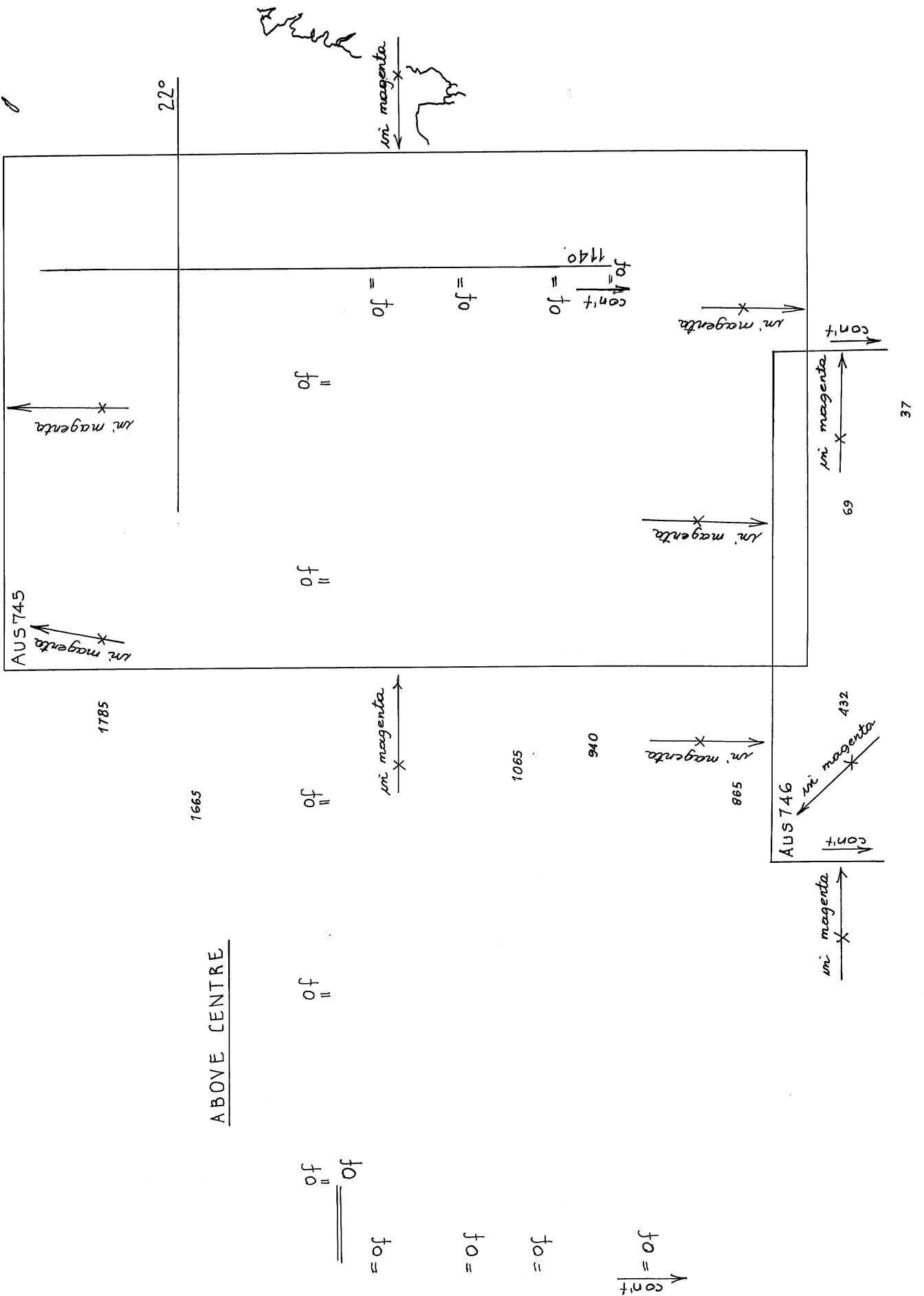

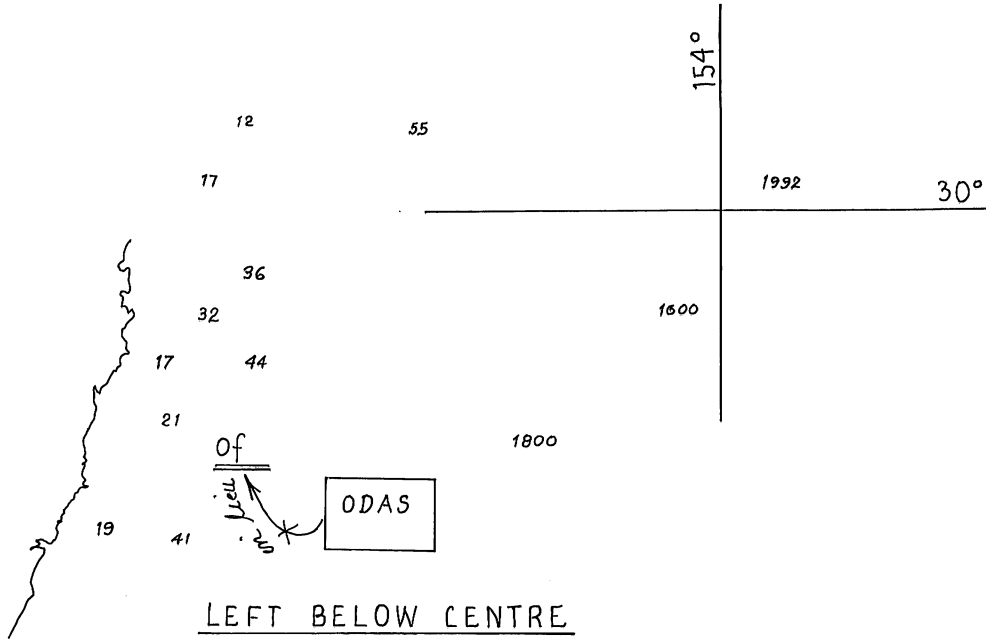

103/2010

247/2010

© commonwealth of Australia 2010

AUS 424

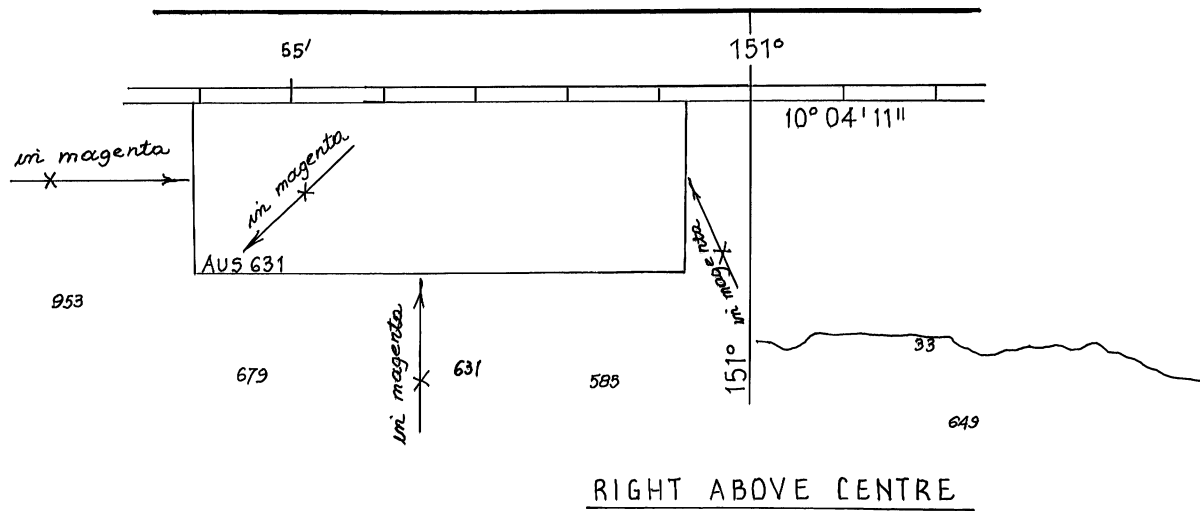

1177/2008

251/2010

© commonwealth of Australia 2010

AUS 508

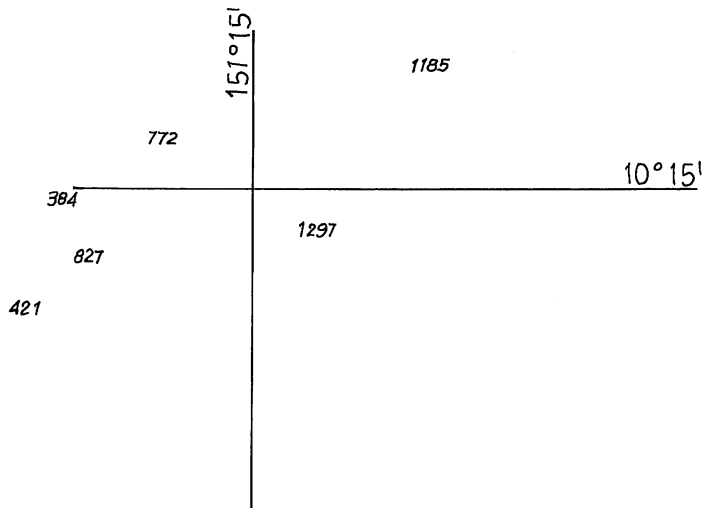

LEFT ABOVE CENTRE

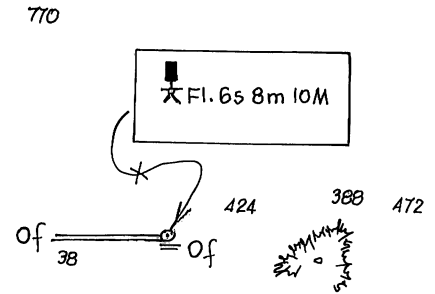

524/2008

250/2010

© Commonwealth of Australia 2010

AUS 509

1418/2009

251/2010

© Commonwealth of Australia 2010

AUS 518

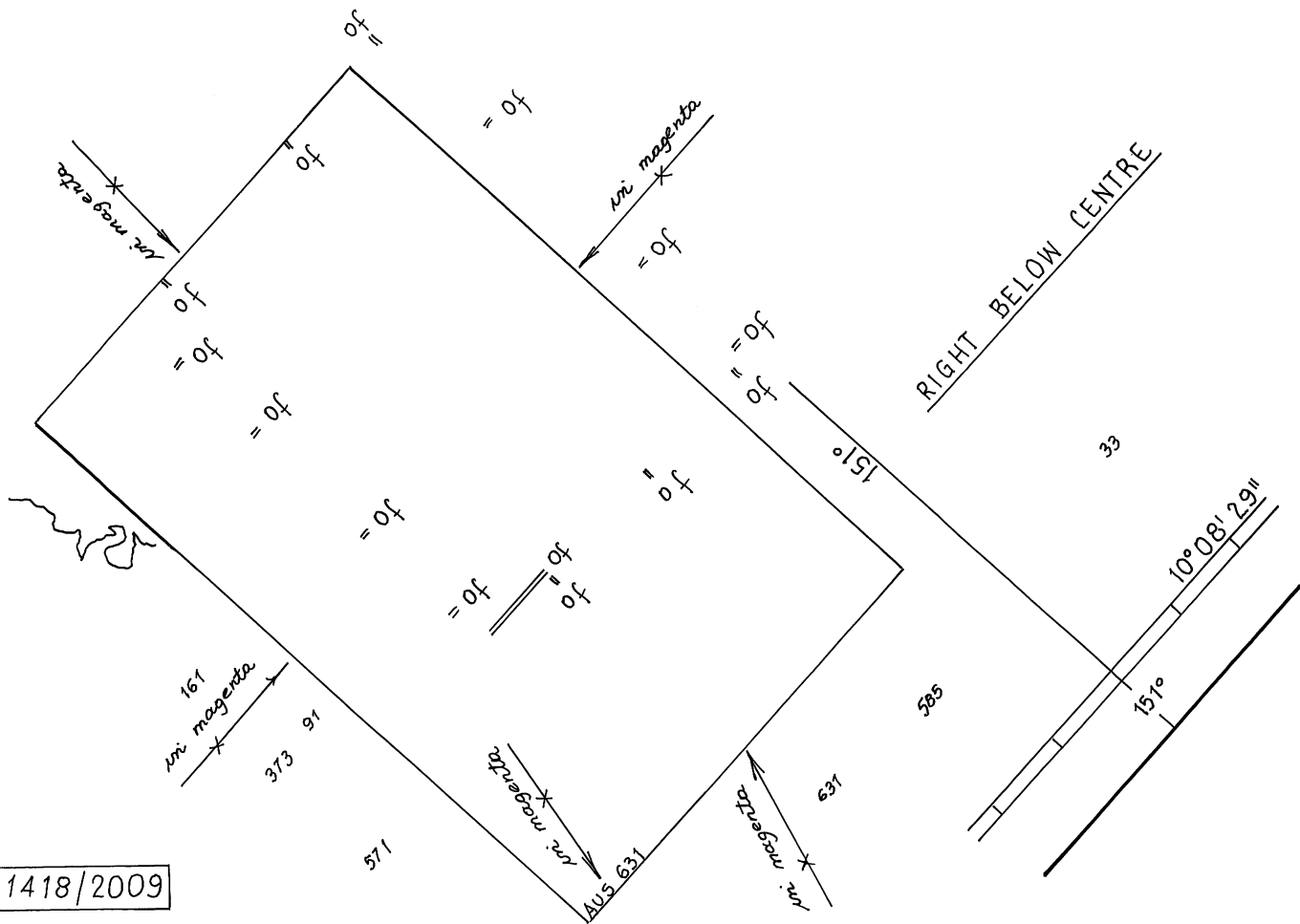

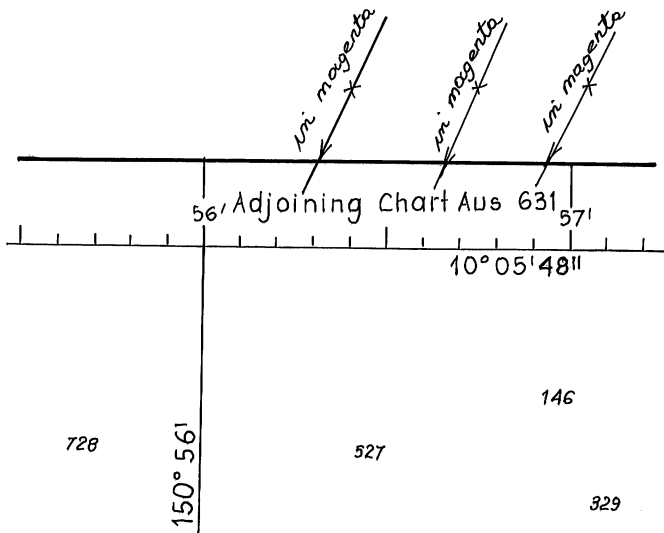

LEFT ABOVE CENTRE

329/2008

251/2010

© Commonwealth of Australia 2010

AUS 628

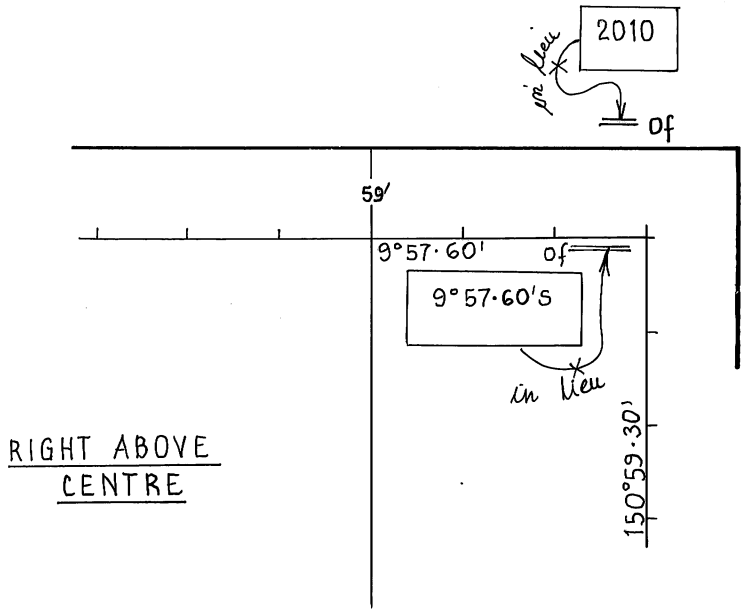

NC 29-1-2010

251/2010

© commonwealth of Australia 2010

AUS 631

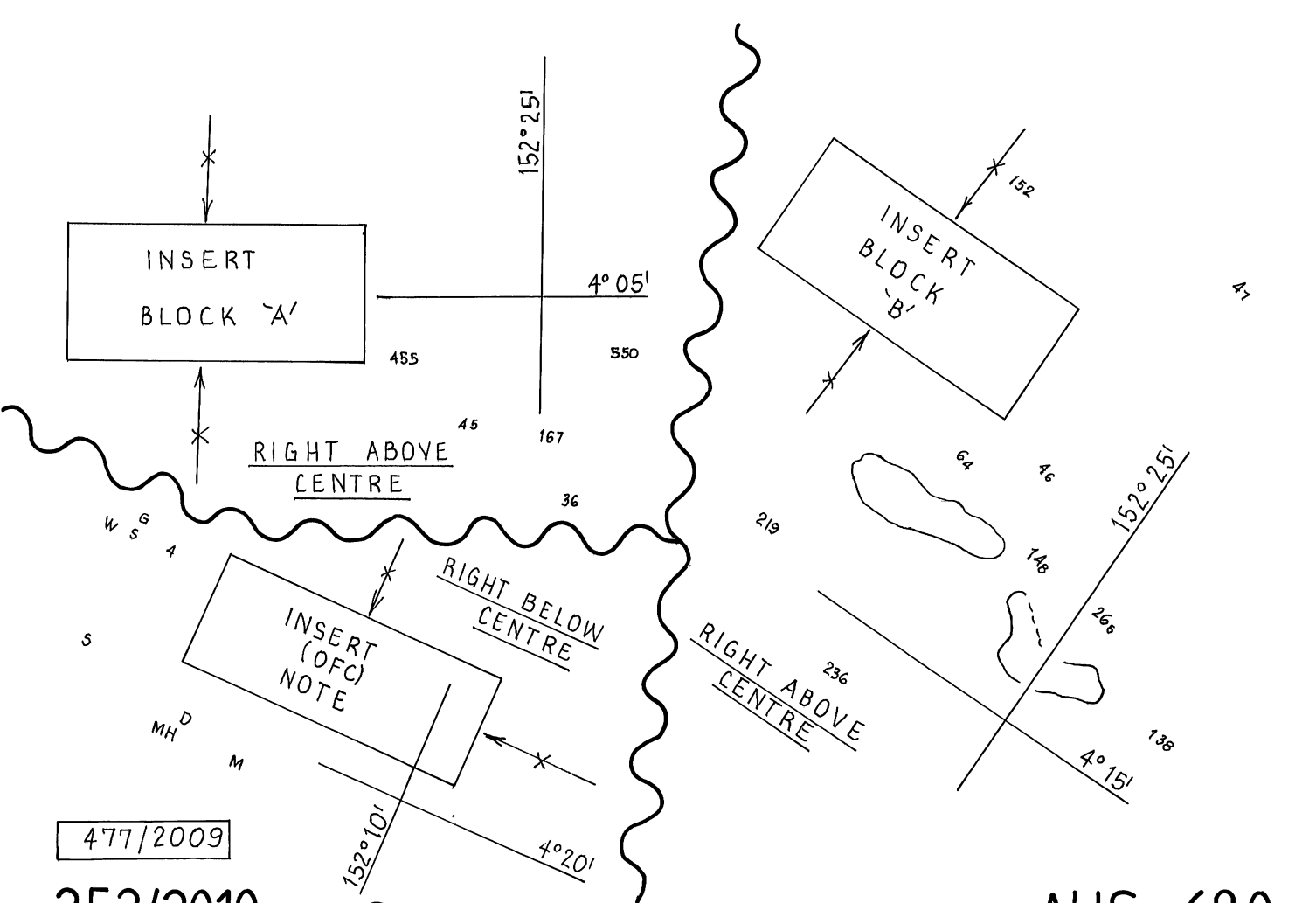

252/2010

© Commonwealth of Australia 2010

AUS 680

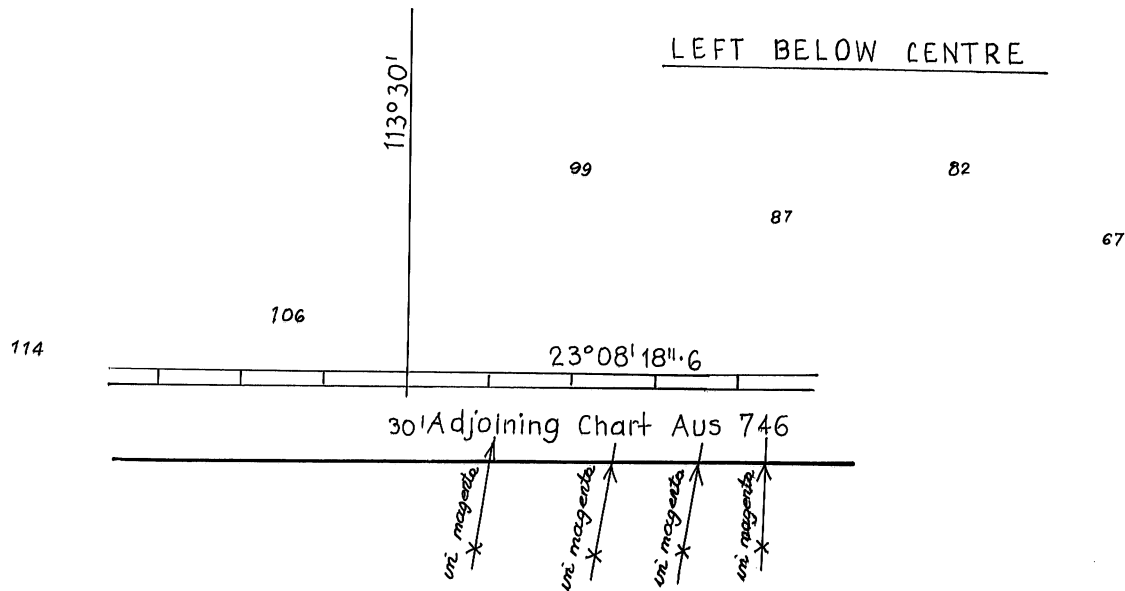

1021/2008

258/2010

© Commonwealth of Australia 2010

AUS 745

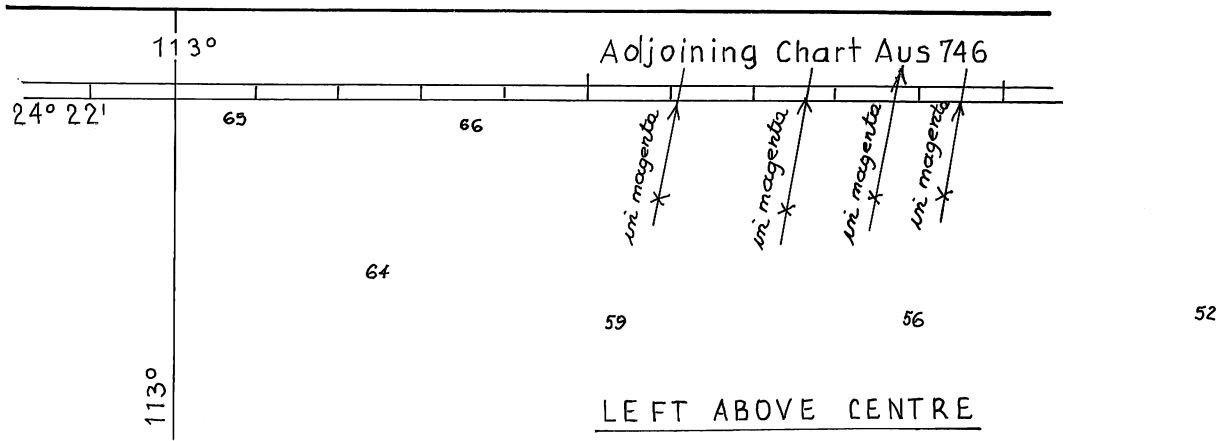

52

63/2009

258/2010

© Commonwealth of Australia 2010

AUS 747

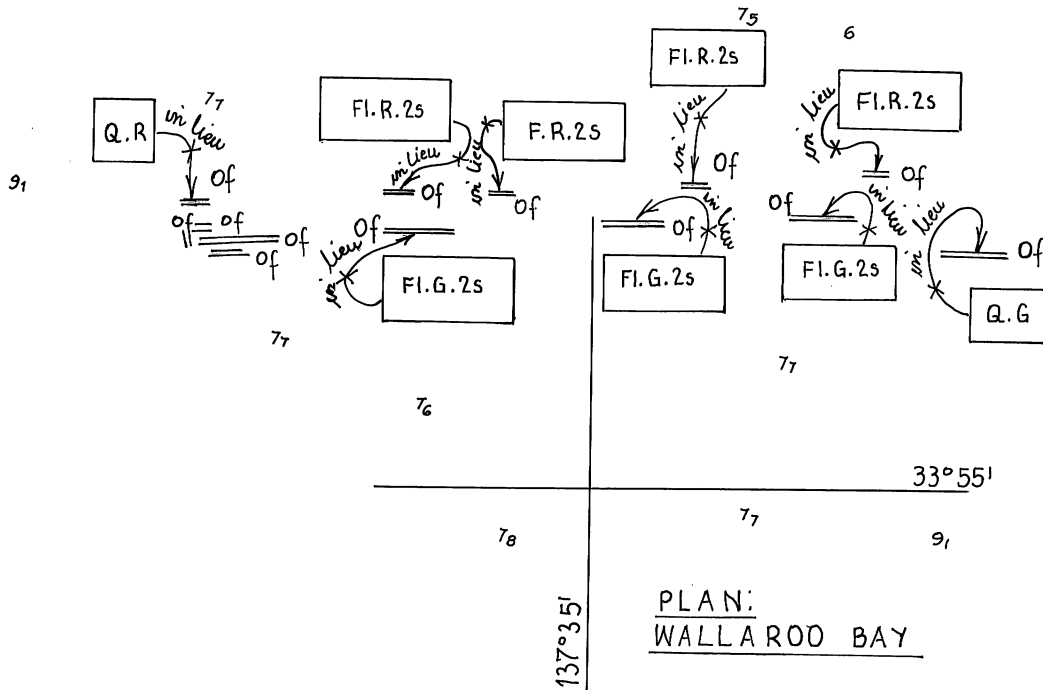

PLAN:
WALLAROD BAY

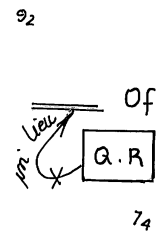

245/2008

263/2010

© Commonwealth of Australia 2010

AUS 777

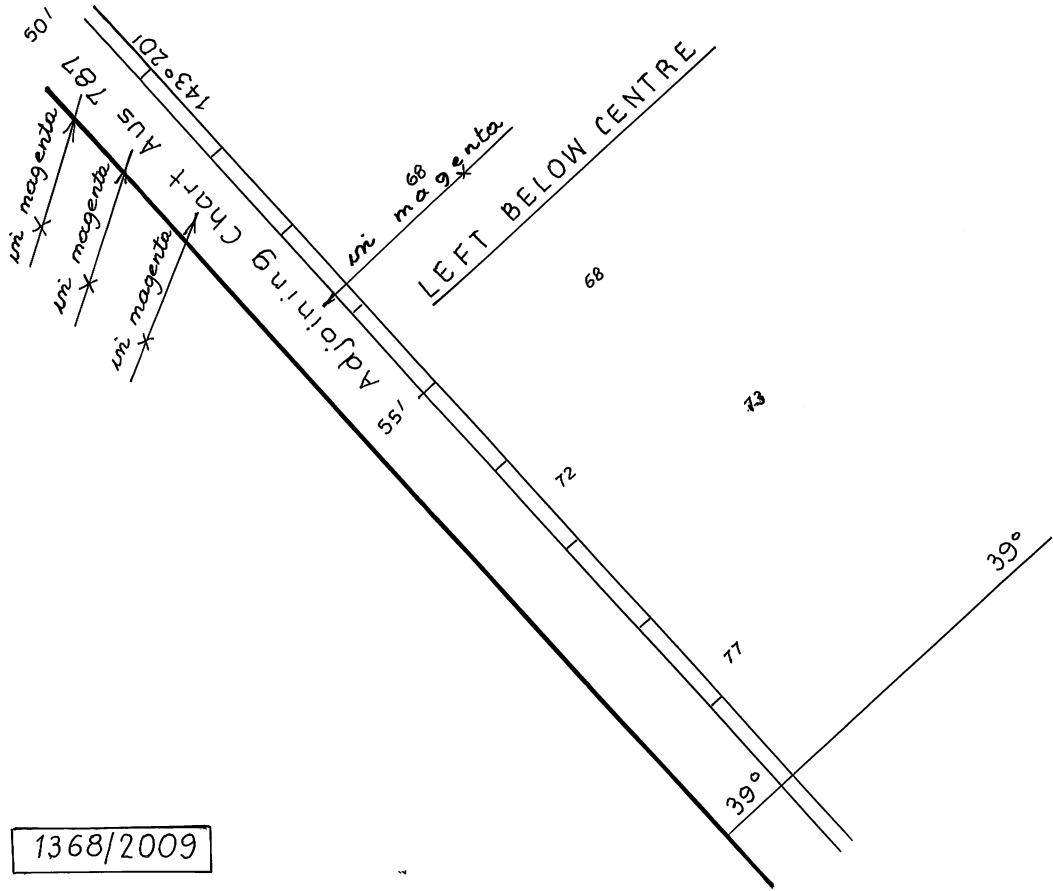

1368/2009

265/2010

© Commonwealth of Australia 2010

AUS 788

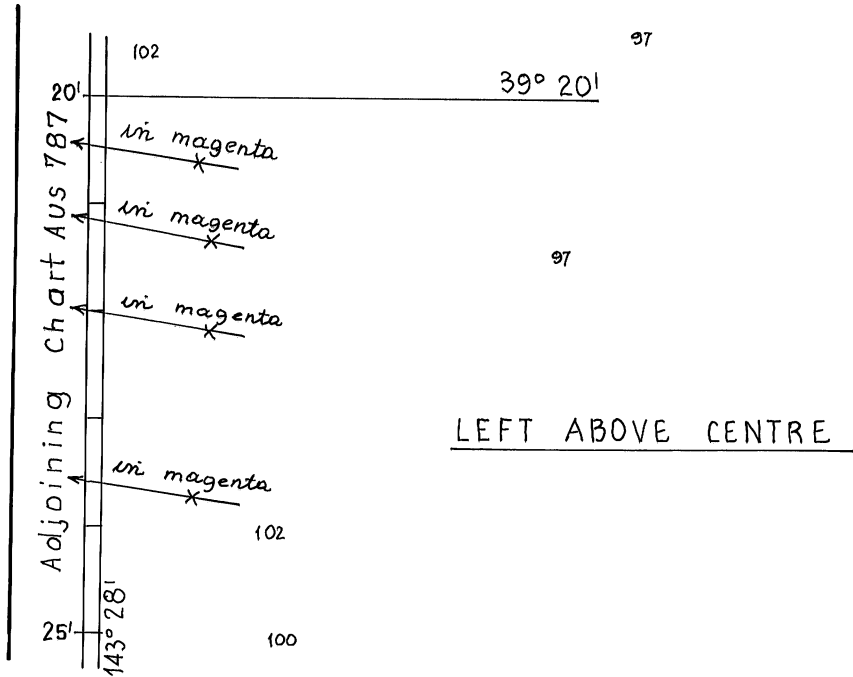

966/2008

265/2010

© Commonwealth of Australia 2010

AUS 789

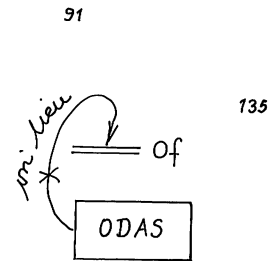
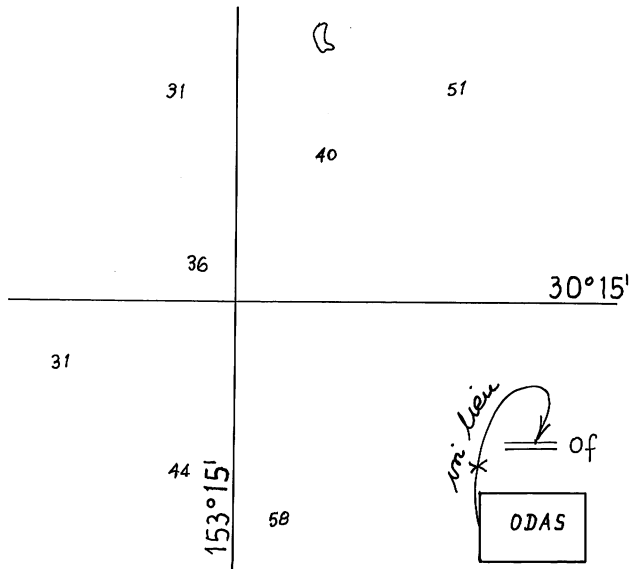

LEFT BELOW CENTRE

195/2010

247/2010

© Commonwealth of Australia 2010

AUS 812

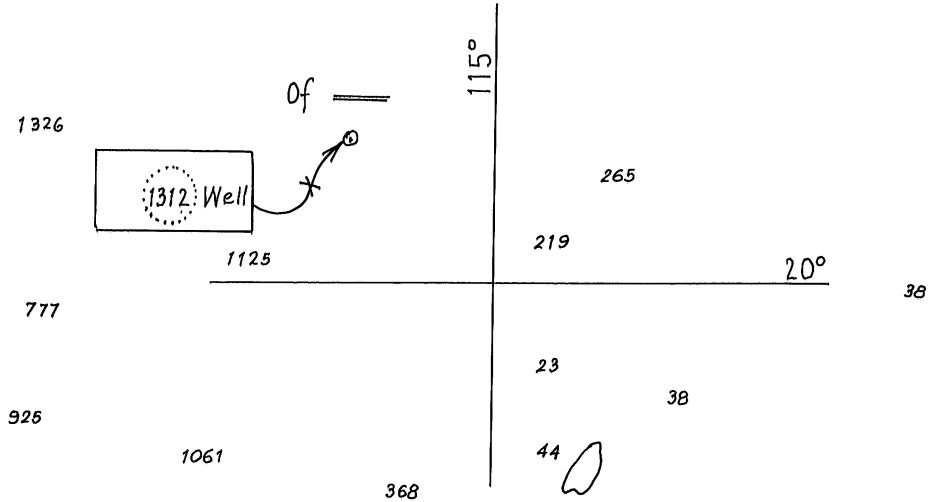

RIGHT ABOVE CENTRE

113/2010

257/2010

© Commonwealth of Australia 2010

INT 708
AUS 4708

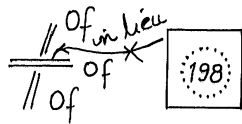

335

3384

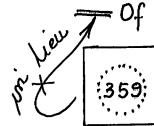

85°

3361

3742

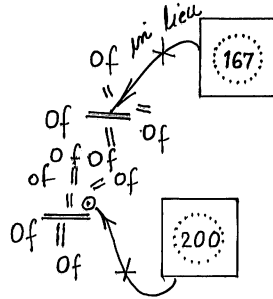

3701

3375

LEFT BELOW
CENTRE

3620

3691

35°

157/2009

260/2010

© Commonwealth of Australia 2010

INT 714
AUS4714

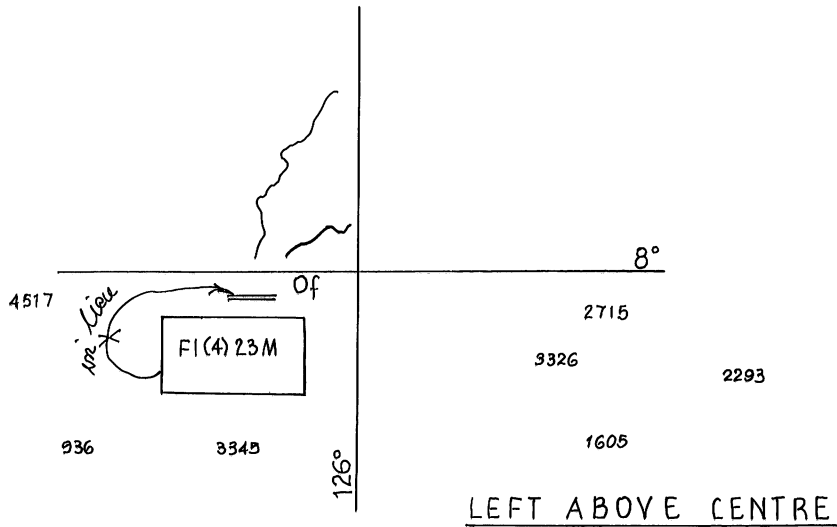

1160/2009

254/2010

© Commonwealth of Australia 2010

INT 721
AUS4721

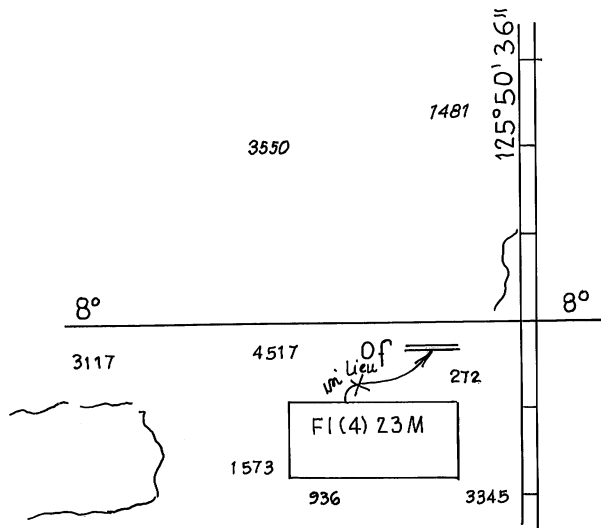

RIGHT ABOVE CENTRE

1176

1160/2009

254/2010

© commonwealth of Australia 2010

INT 722

AUS4722