

691/2009

985/2009

© Commonwealth of Australia 2009

AUS 221

LEFT BELOW CENTRE

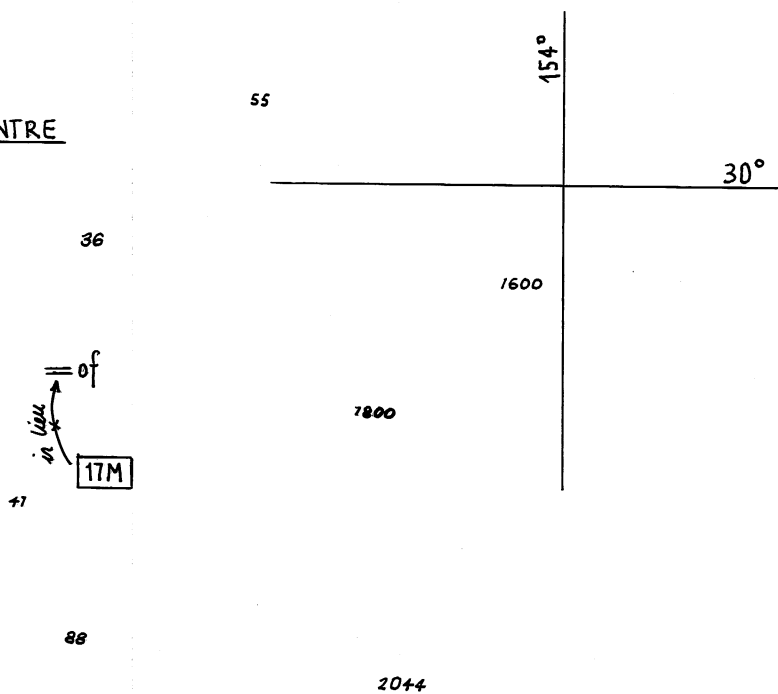

805/2009

985/2009

© Commonwealth of Australia 2009

AUS 424

LEFT BELOW CENTRE

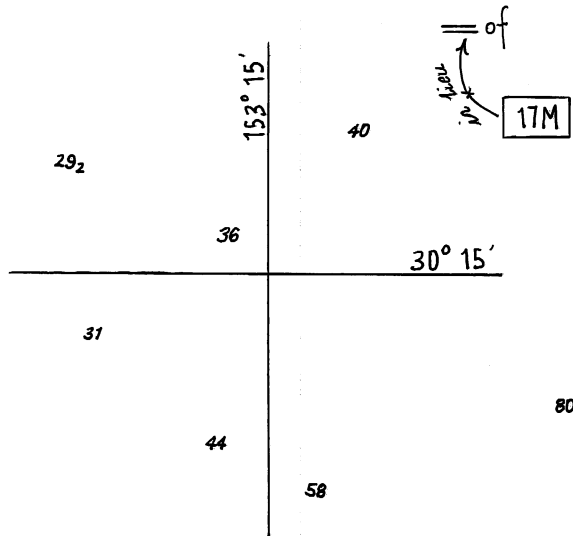

810/2009

985/2009

© Commonwealth of Australia 2009

AUS 812

RIGHT BELOW CENTRE

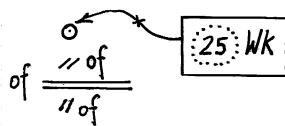
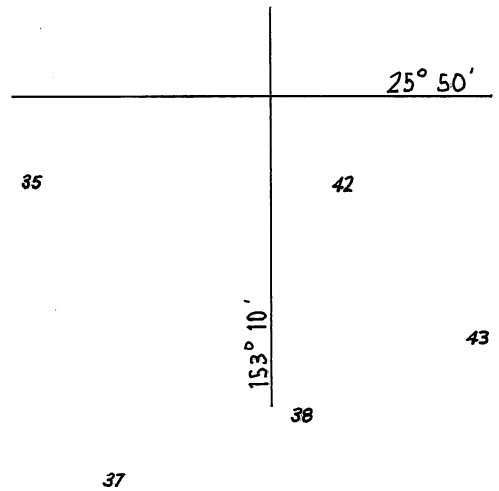

936/2009

986/2009

© Commonwealth of Australia 2009

AUS 240

LEFT BELOW CENTRE

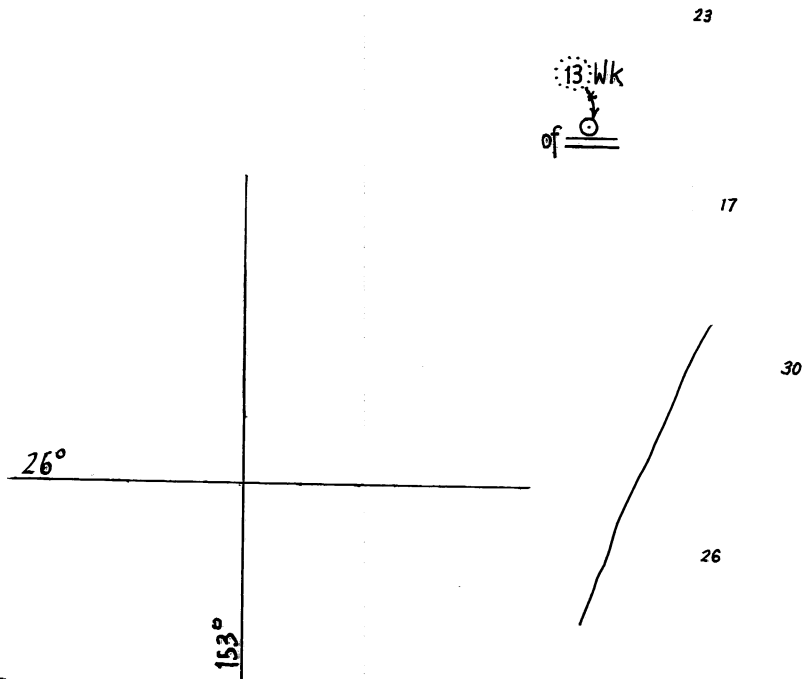

936/2009

986/2009

© Commonwealth of Australia 2009

AUS 365

PLAN:
GLADSTONE AND ADJACENT
WHARVES

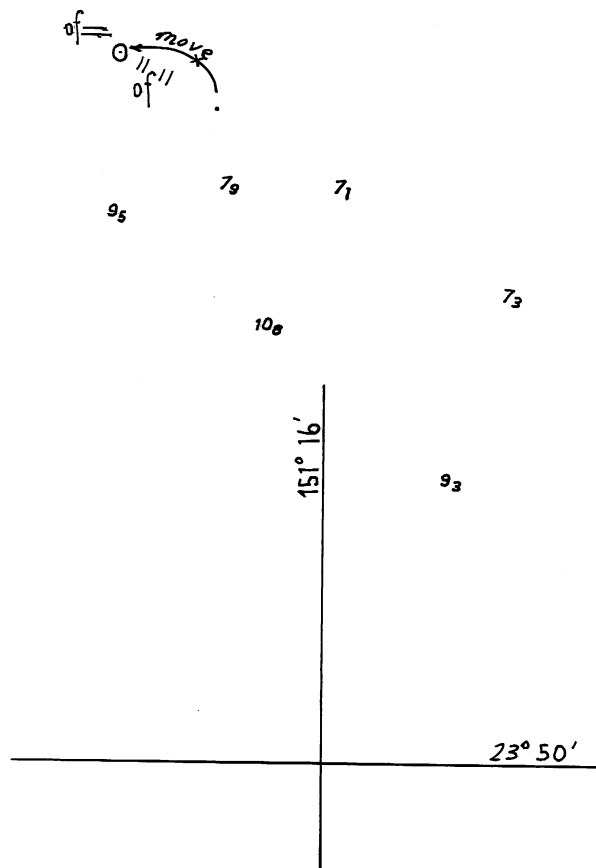

937/2009

987/2009

© Commonwealth of Australia 2009

AUS 244

LEFT BELOW CENTRE

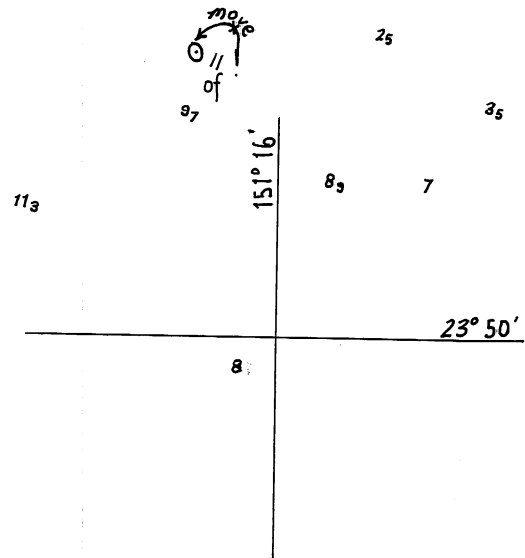

937/2009

987/2009

© Commonwealth of Australia 2009

AUS 245

RIGHT ABOVE CENTRE

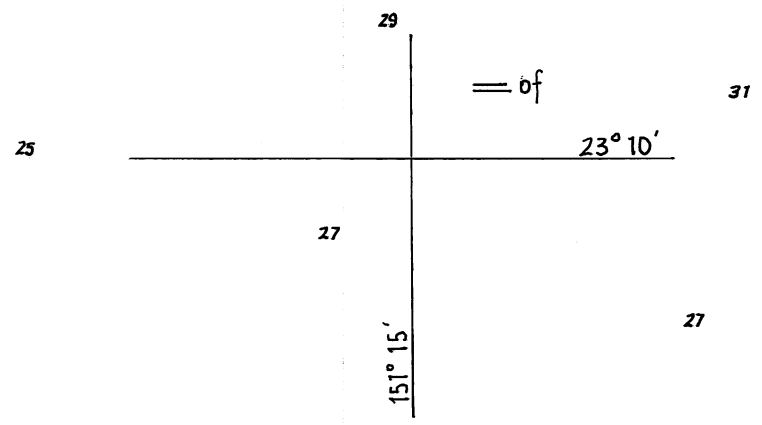

593/2009

988/2009

© Commonwealth of Australia 2009

AUS 247

LEFT ABOVE CENTRE

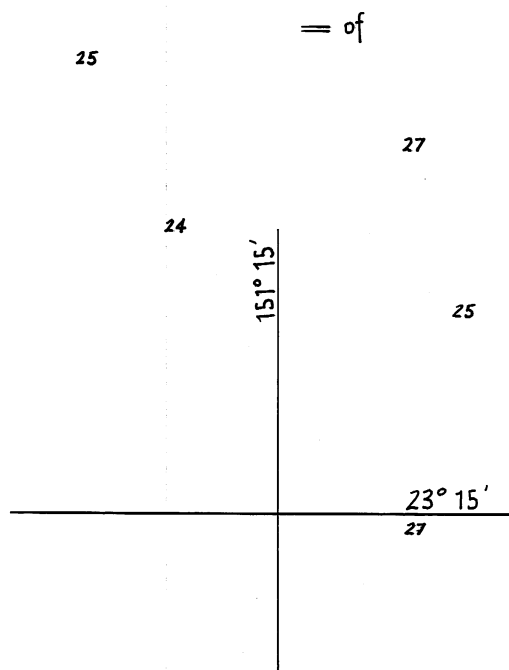

695/2009

988/2009

© Commonwealth of Australia 2009

AUS 819

LEFT BELOW CENTRE

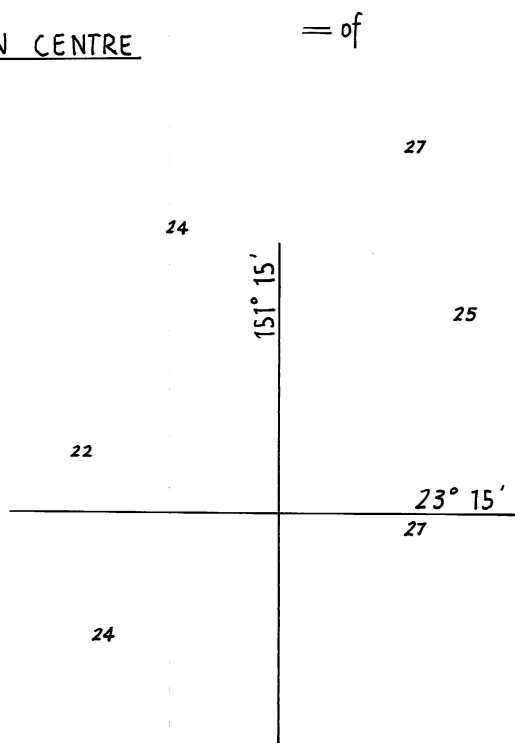

695/2009

988/2009

© Commonwealth of Australia 2009

AUS 820

LEFT BELOW CENTRE

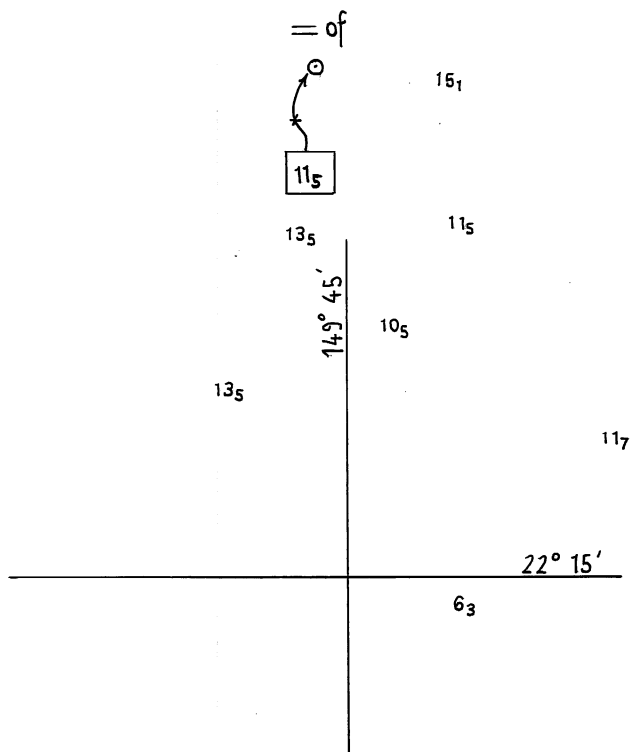

938/2009

989/2009

© Commonwealth of Australia 2009

AUS 822

RIGHT BELOW CENTRE

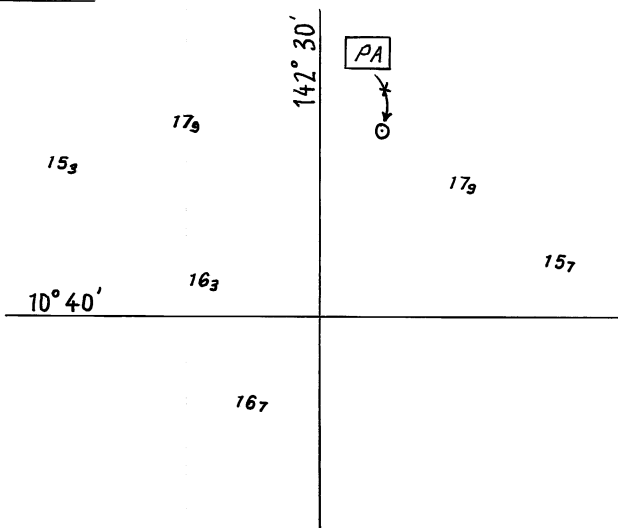

647/2009

990/2009

© Commonwealth of Australia 2009

AUS 292

LEFT BELOW CENTRE

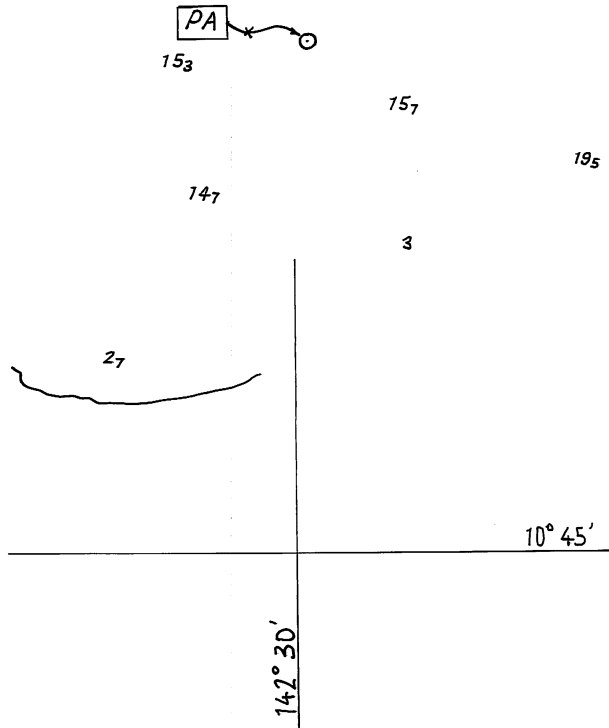

647/2009

990/2009

© Commonwealth of Australia 2009

AUS 839

LEFT OF CENTRE

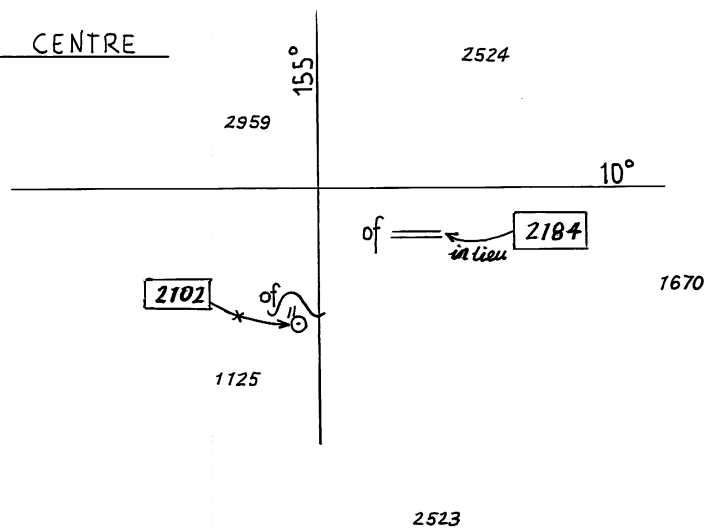

944/2009

991/2009

© Commonwealth of Australia 2009

INT 604
AUS 4604

RIGHT ABOVE CENTRE

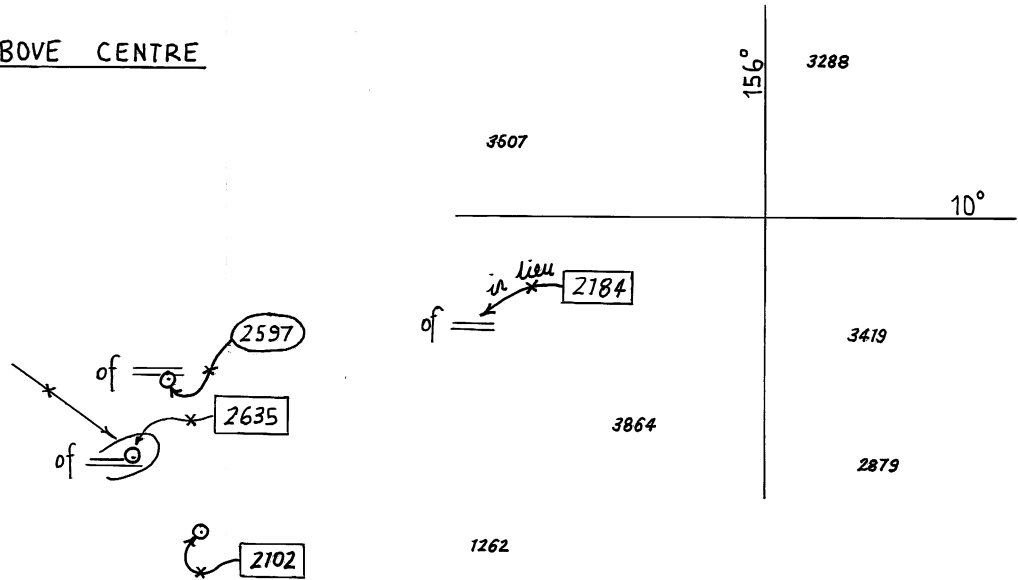

755/2009

991/2009

© Commonwealth of Australia 2009

INT 621
AUS 4621

LEFT BELOW CENTRE

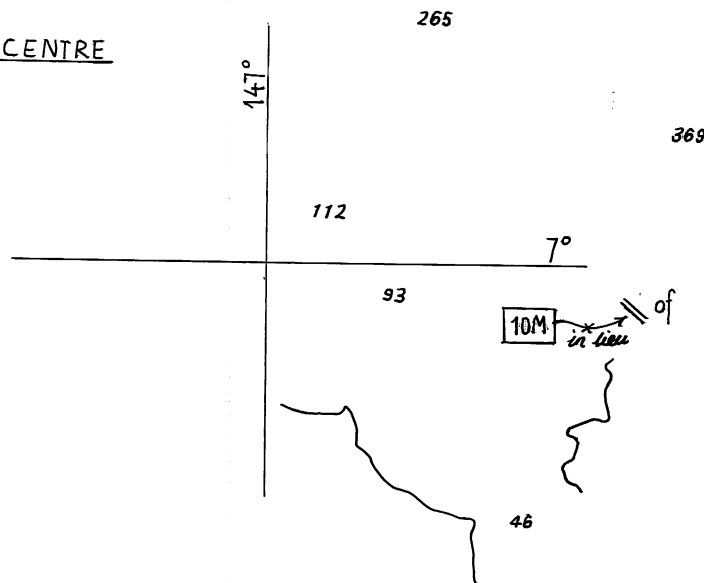

942/2009

992/2009

© Commonwealth of Australia 2009

AUS 523

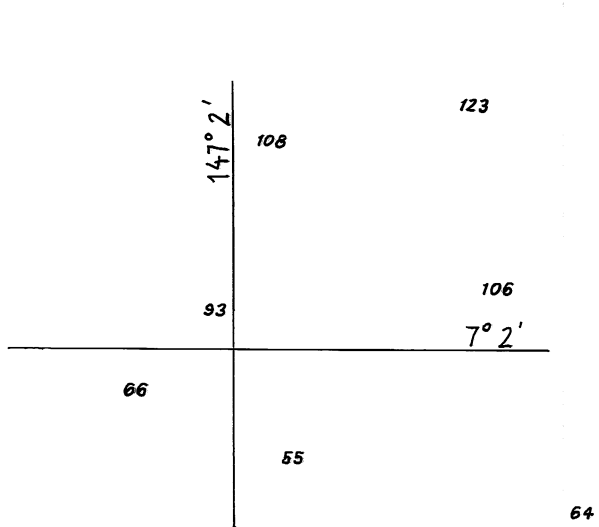

10M
in view

PLAN:
SALAMAUA HARBOUR

639/2007

992/2009

© Commonwealth of Australia 2009

AUS 644

10M
in view

110

2039

RIGHT ABOVE CENTRE

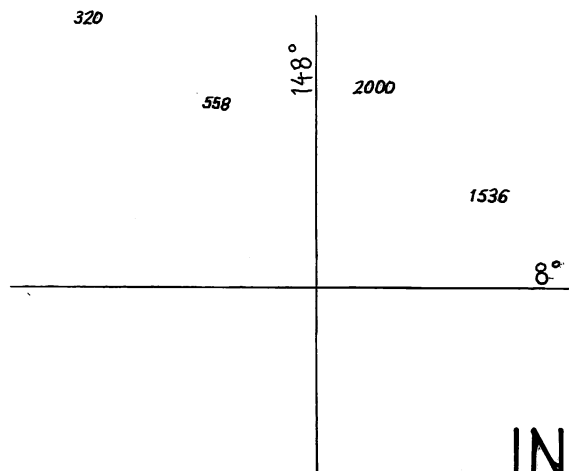

942/2009

992/2009

© Commonwealth of Australia 2009

INT 620

AUS 4620

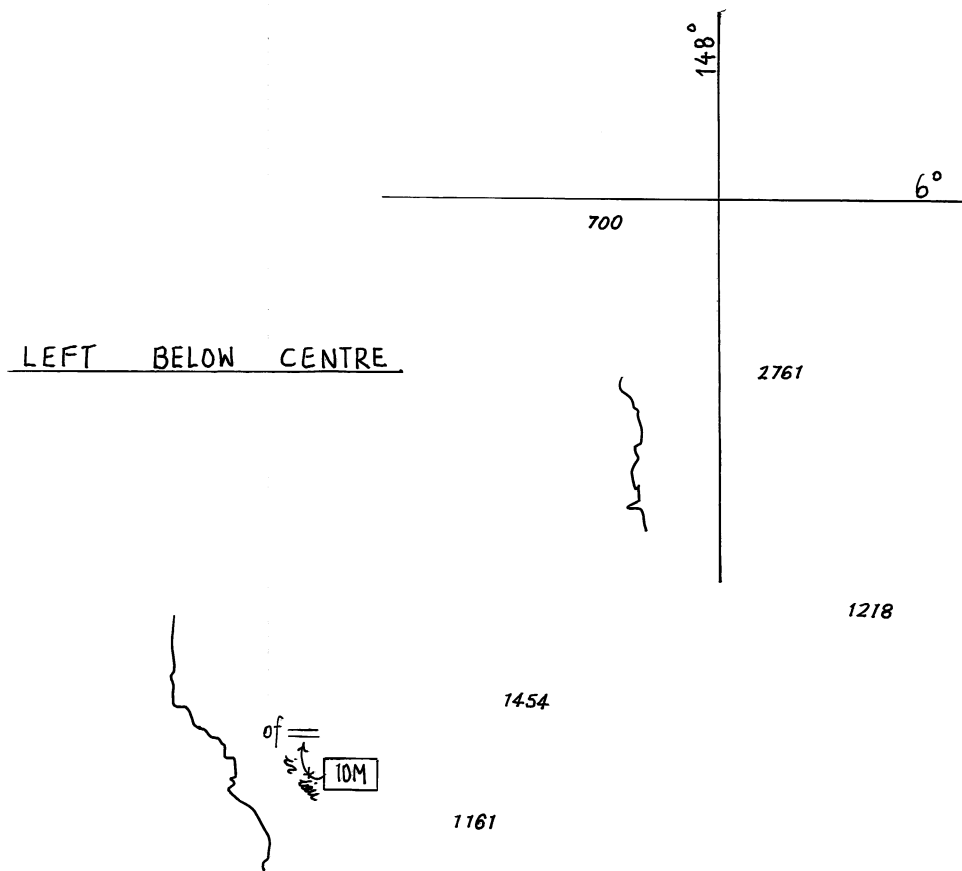

944/2009

992/2009

© Commonwealth of Australia 2009

INT 622
AUS 4622

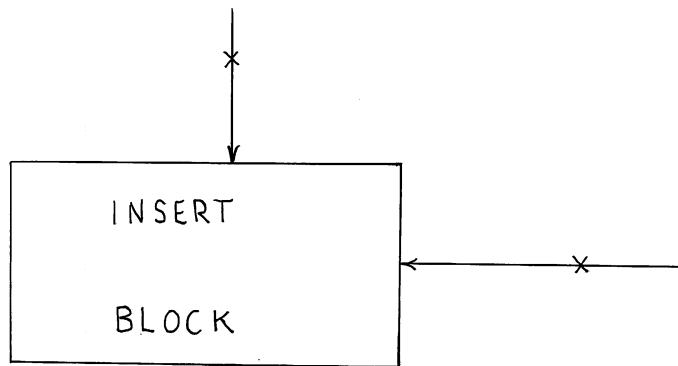

LEFT BELOW CENTRE

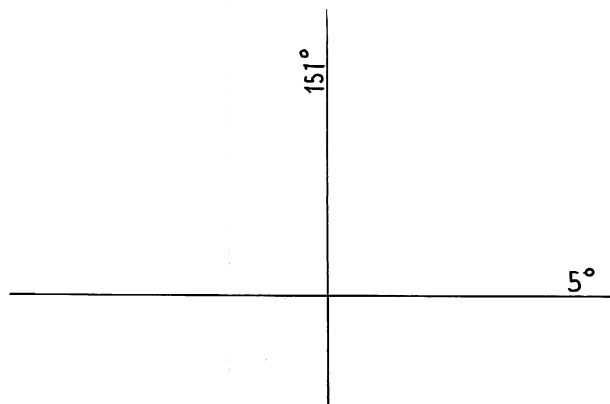

759 /2009

993/2009

© Commonwealth of Australia 2009

AUS 546

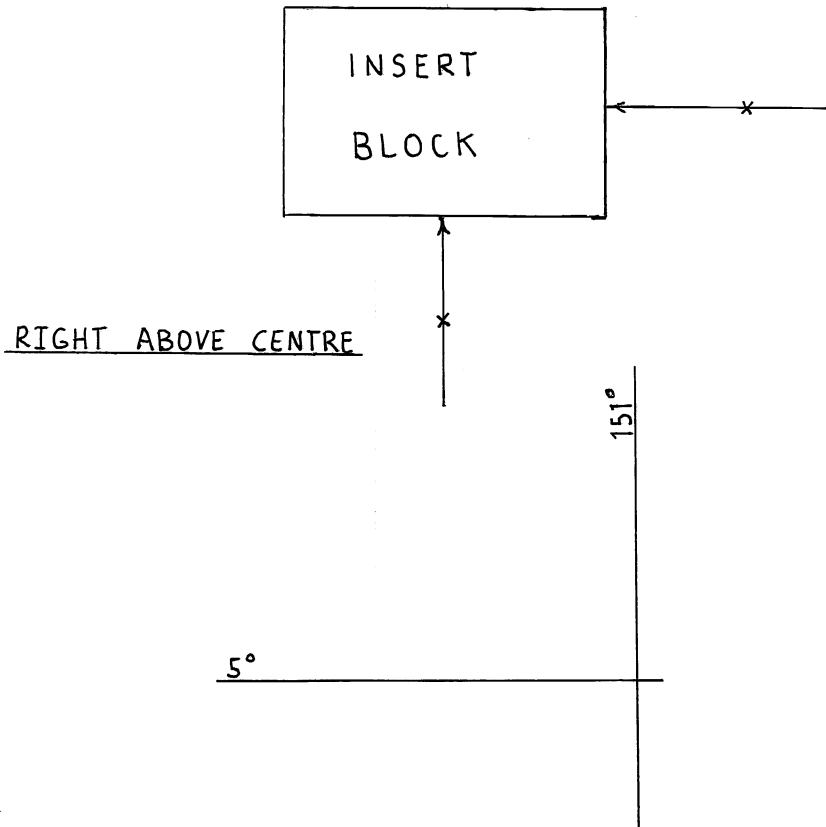

47 / 2009

993 / 2009

© Commonwealth of Australia 2009

AUS 547

LEFT ABOVE CENTRE

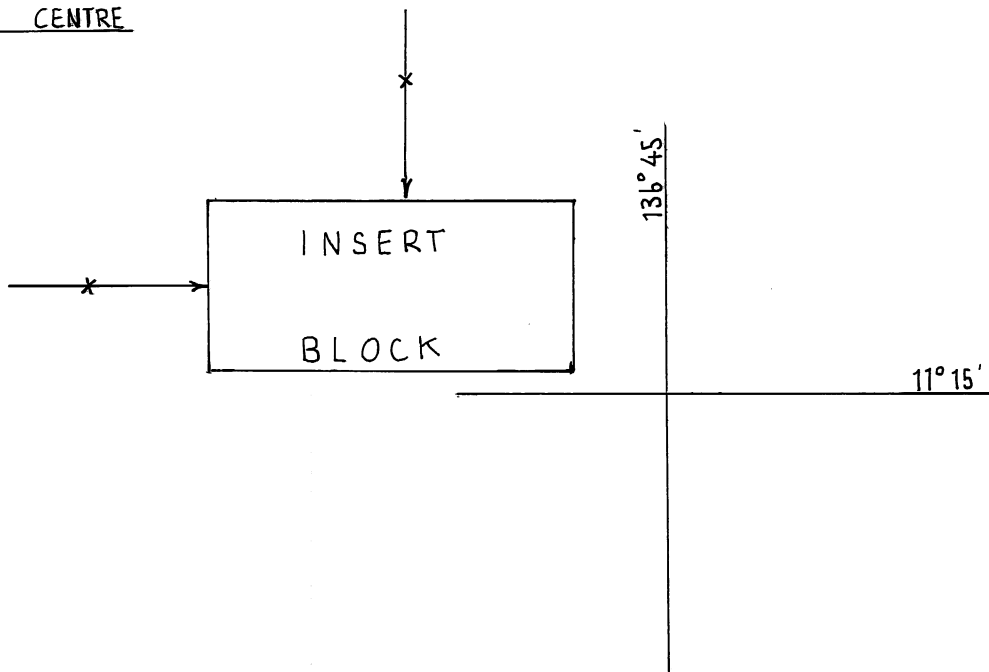

760 / 2009

994 / 2009

© Commonwealth of Australia 2009

AUS 715

RIGHT BELOW CENTRE

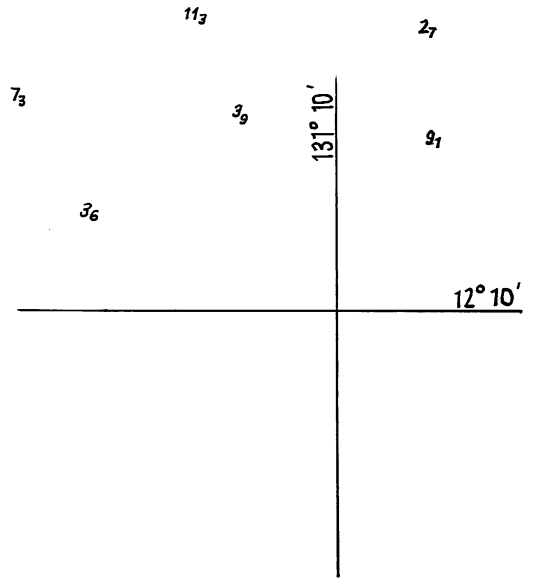
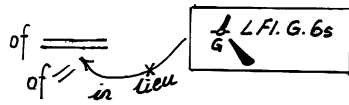

484/2009

995/2009

© Commonwealth of Australia 2009

AUS 20

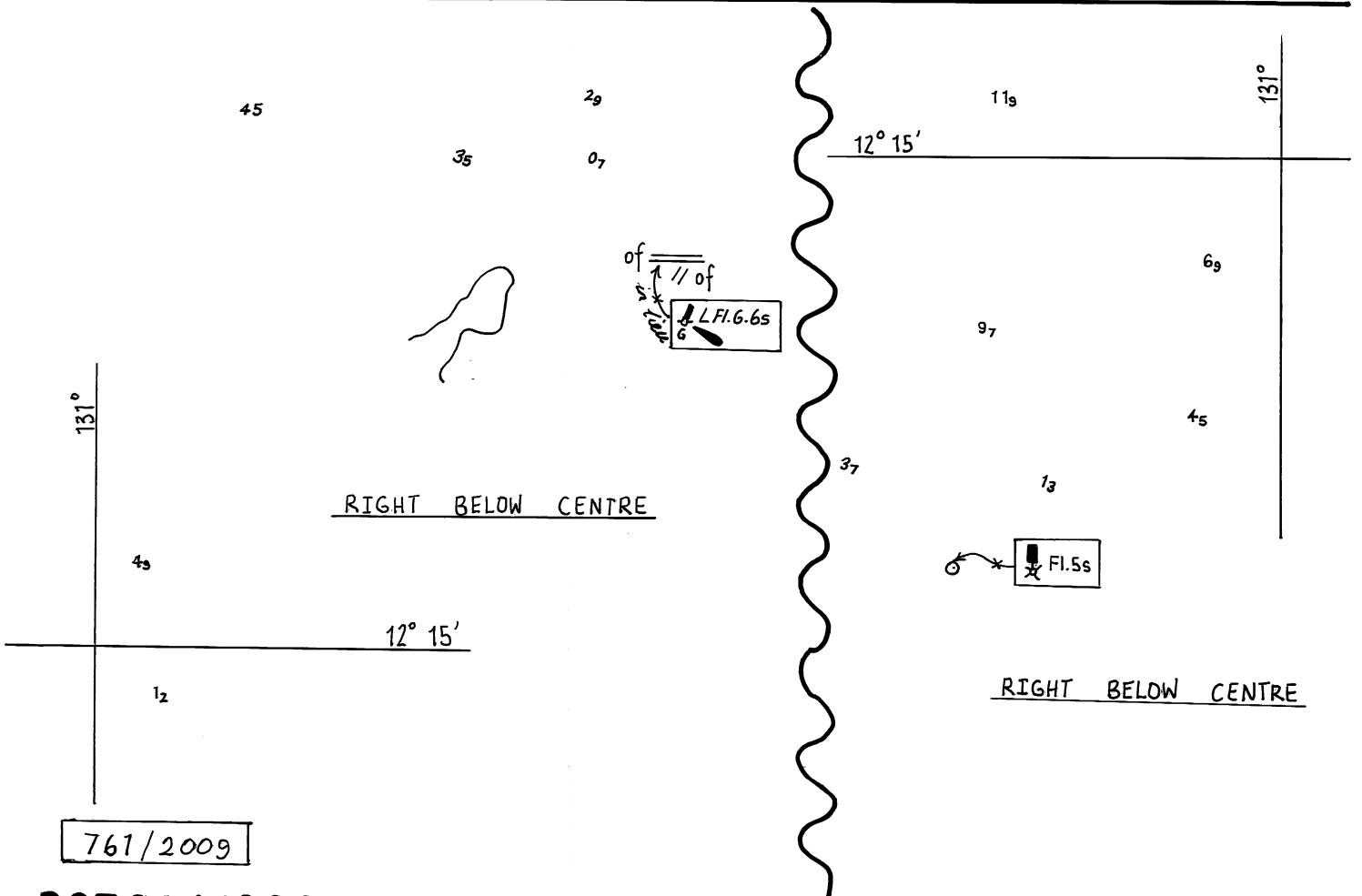

761/2009

995,996/2009

© Commonwealth of Australia 2009

AUS 722

RIGHT ABOVE CENTRE

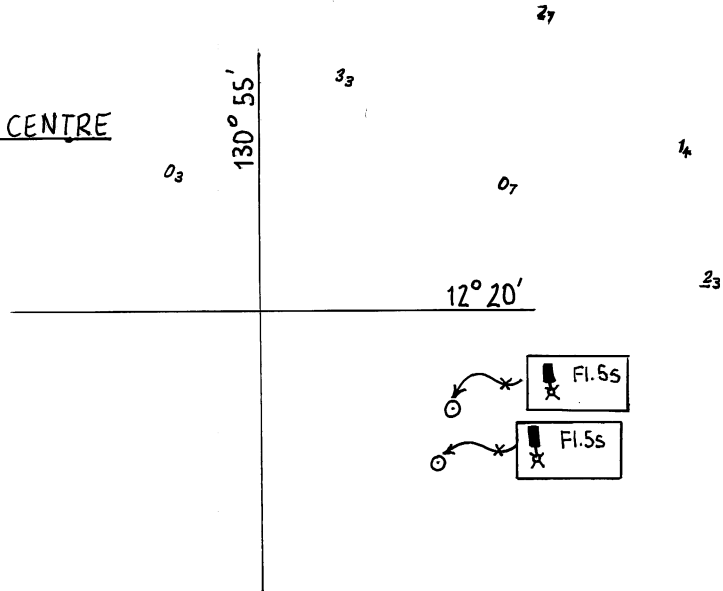

867/2009

996/2009

© Commonwealth of Australia 2009

AUS 26

RIGHT BELOW CENTRE

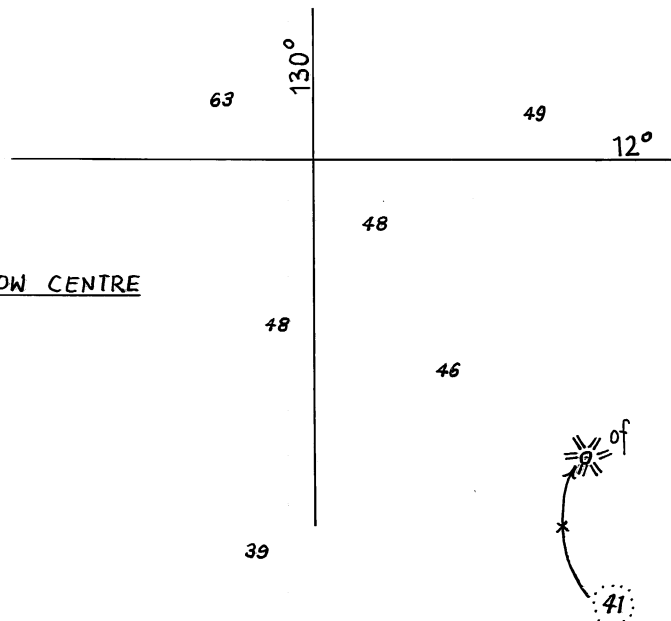

543/2009

997/2009

© Commonwealth of Australia 2009

AUS 309

LEFT ABOVE CENTRE



43

45

50

45

52

56

130° 15'

12°

37

996/2009

997/2009

© Commonwealth of Australia 2009

AUS 722

LEFT ABOVE CENTRE

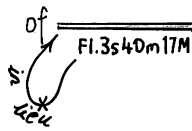

507

8° 02' 01"

1076

3329

1441

30'

125° 30'

947/2009

998/2009

© Commonwealth of Australia 2009

AUS 313

LEFT ABOVE CENTRE

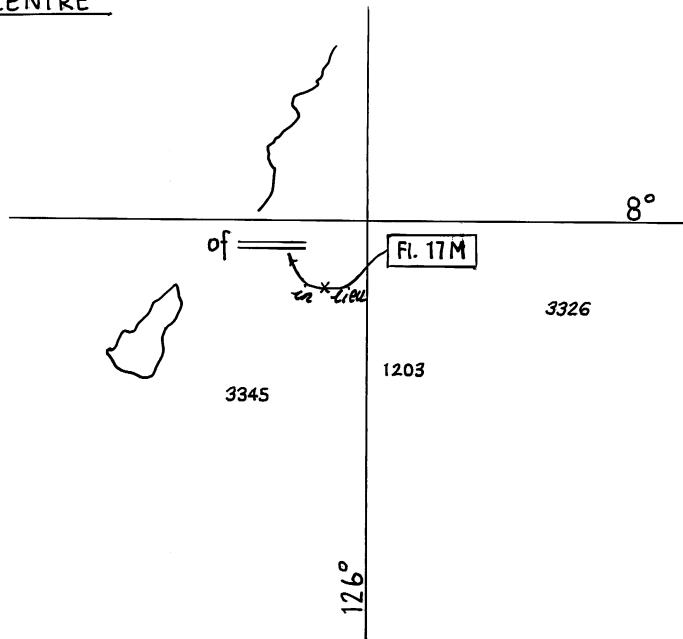

868/2009

998/2009

© Commonwealth of Australia 2009

INT 721

AUS 4721

RIGHT ABOVE CENTRE

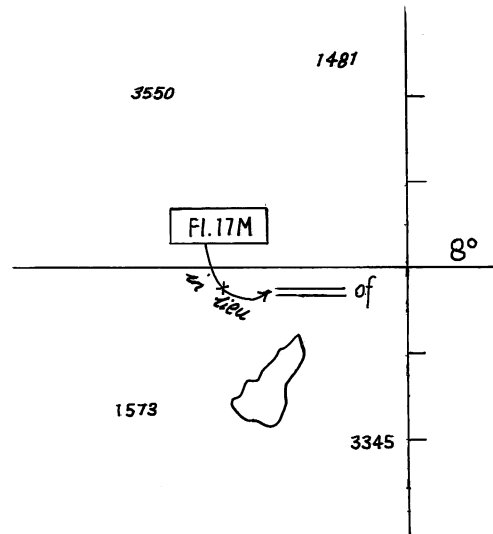

648/2009

998/2009

© Commonwealth of Australia 2009

INT 722

AUS 4722

LEFT BELOW CENTRE

26°

110°

4128

LEFT BELOW CENTRE

4330

4308

4746

5616

4740

110°

28°

CON'T

in magenta

112°E

in magenta

in magenta

5488

in magenta

in magenta

in magenta

5455

LEFT BELOW CENTRE

5530

5479

CON'T

829/2009

1001/2009

© Commonwealth of Australia 2009

AUS 416

PLAN: COFFIN BAY

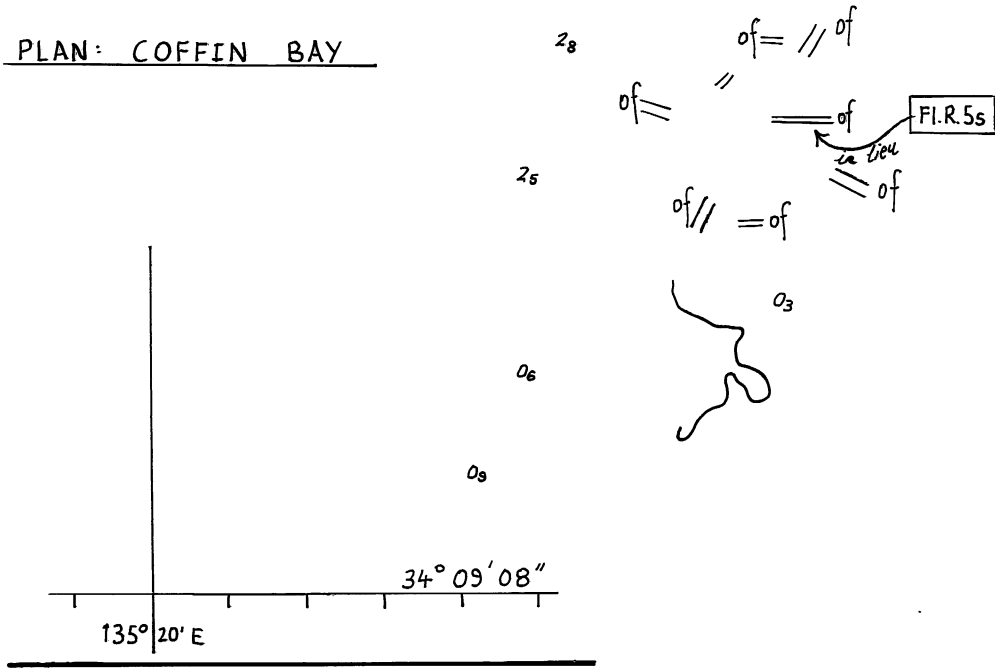

1186 / 2008

1002 / 2009

© Commonwealth of Australia 2009

AUS 121

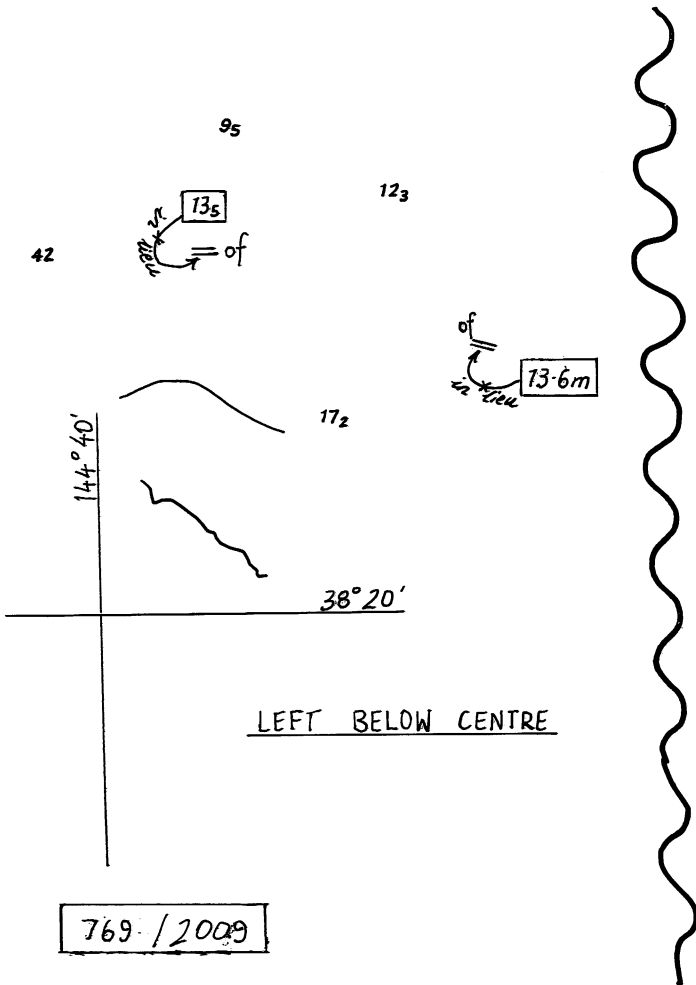

769 / 2009

1003 / 2009

© Commonwealth of Australia 2009

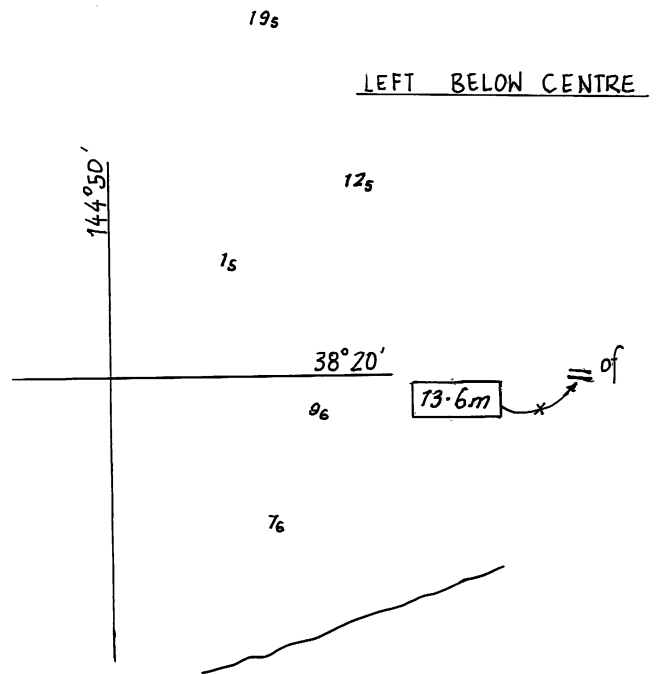

AUS 143

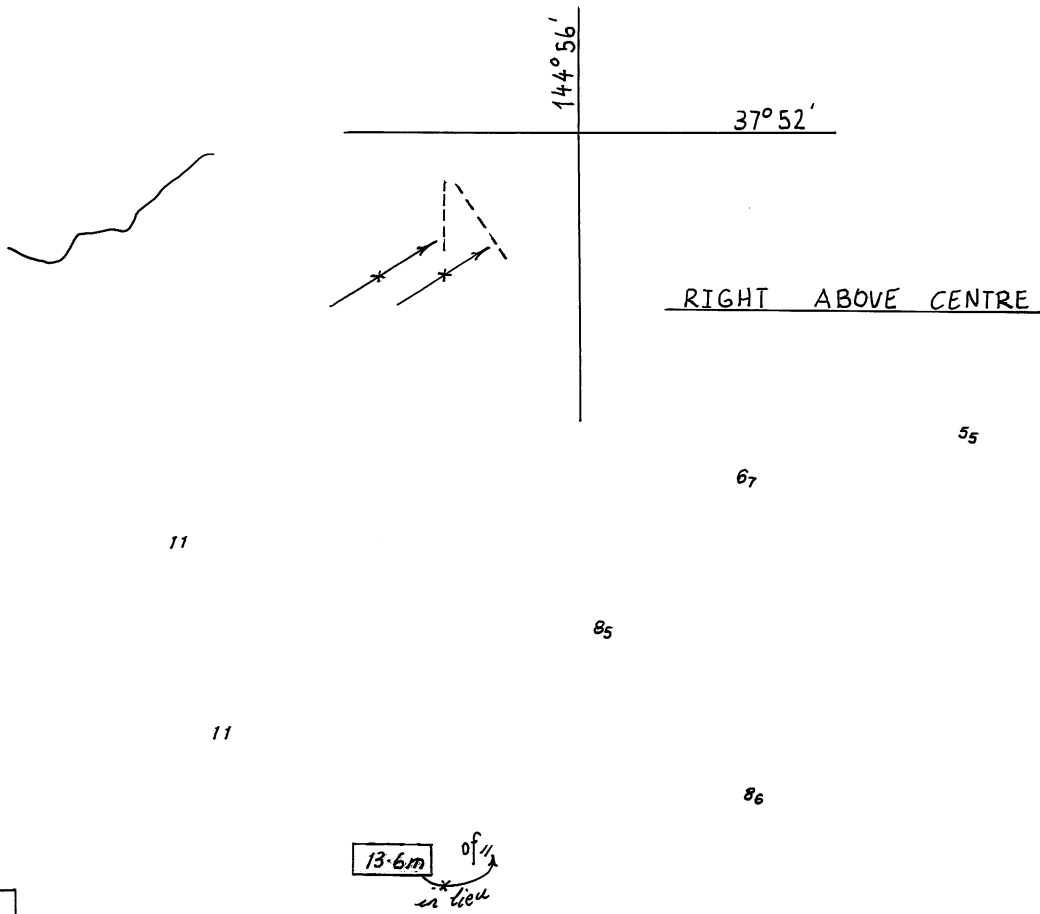

882/2009

1003/2009

© Commonwealth of Australia 2009

AUS 155

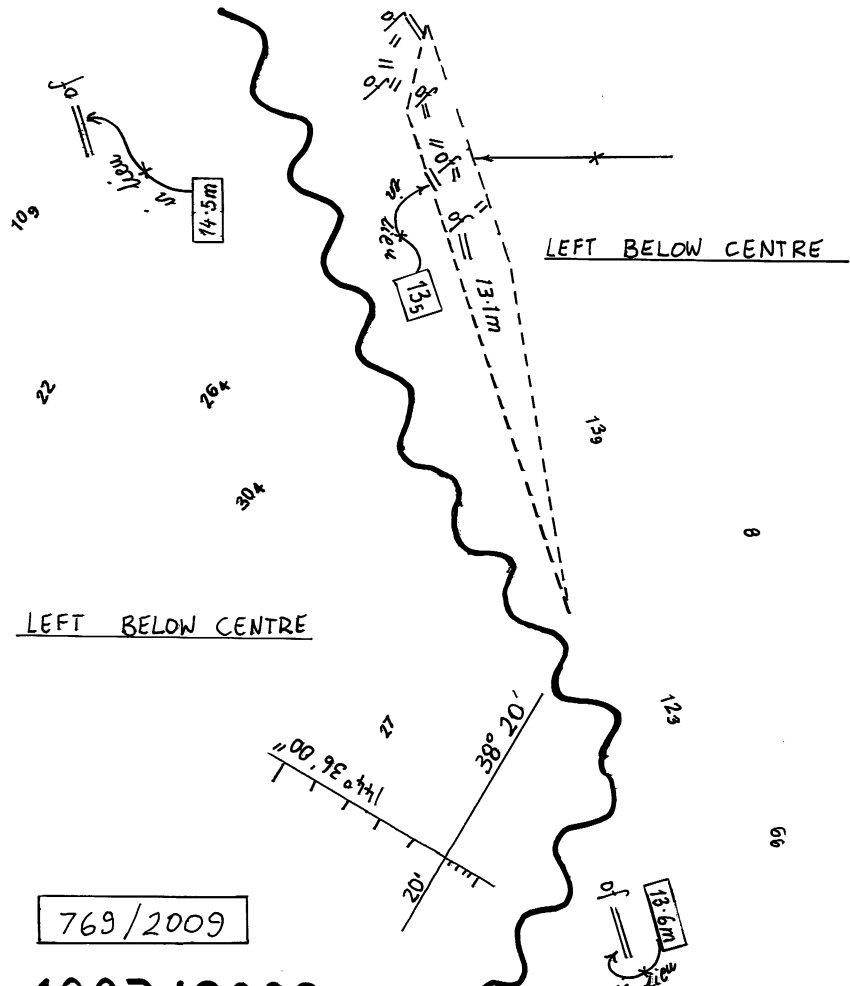

769/2009

1003/2009

© Commonwealth of Australia 2009

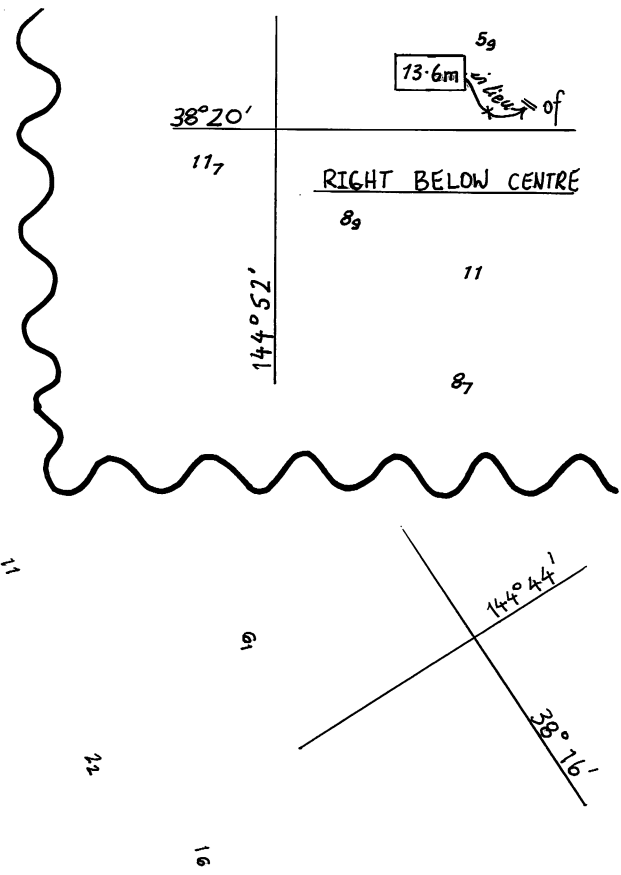

AUS 158

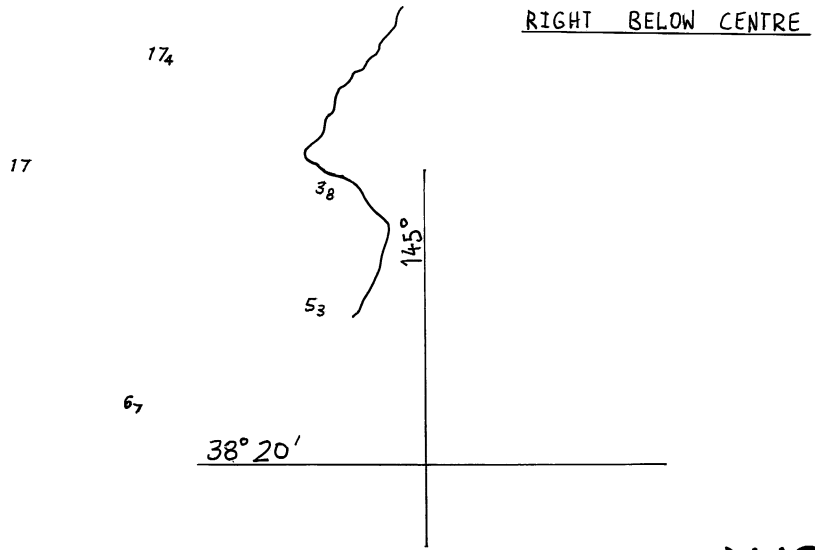
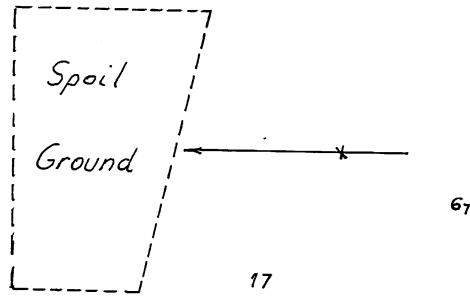

769/2009

1004/2009

© Commonwealth of Australia 2009

AUS 143

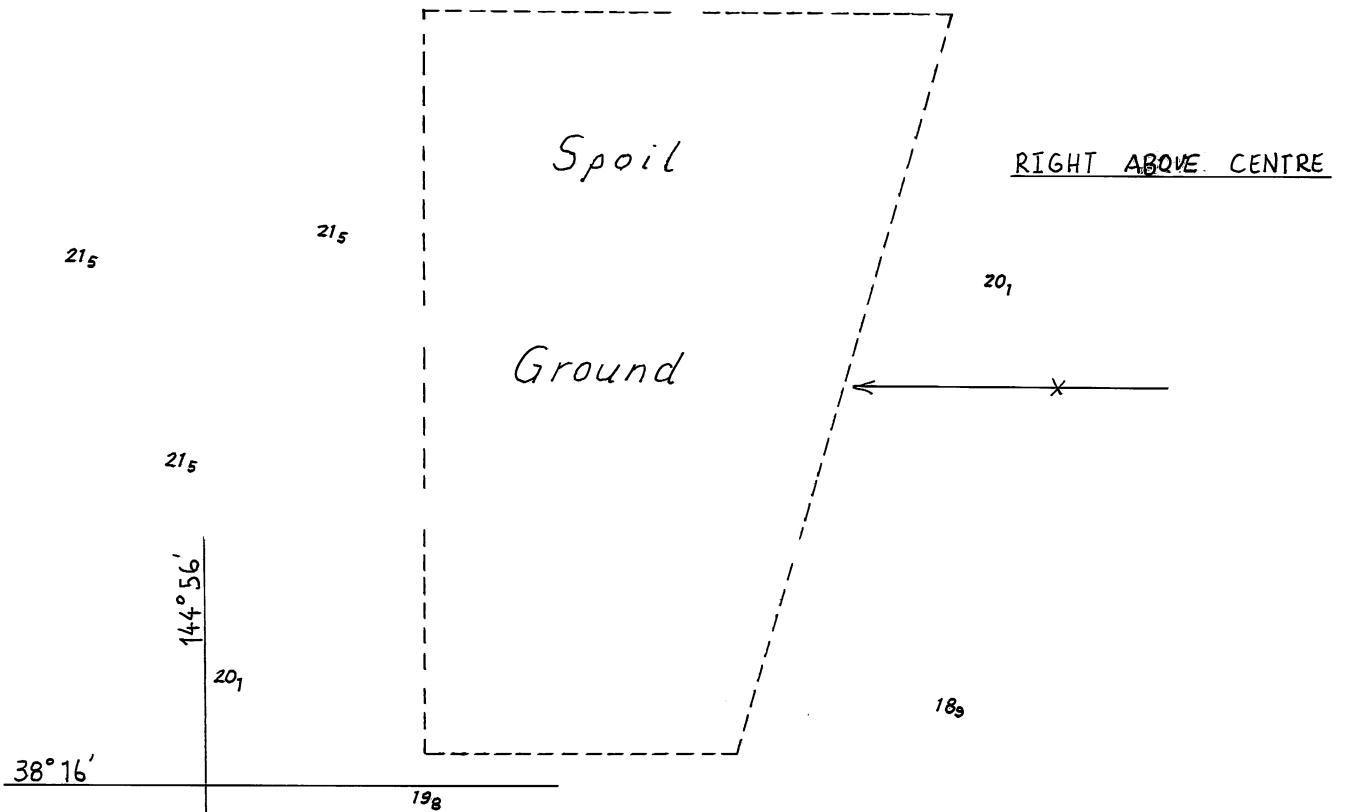

769/2009

1004/2009

© Commonwealth of Australia 2009

AUS 158

RIGHT ABOVE CENTRE

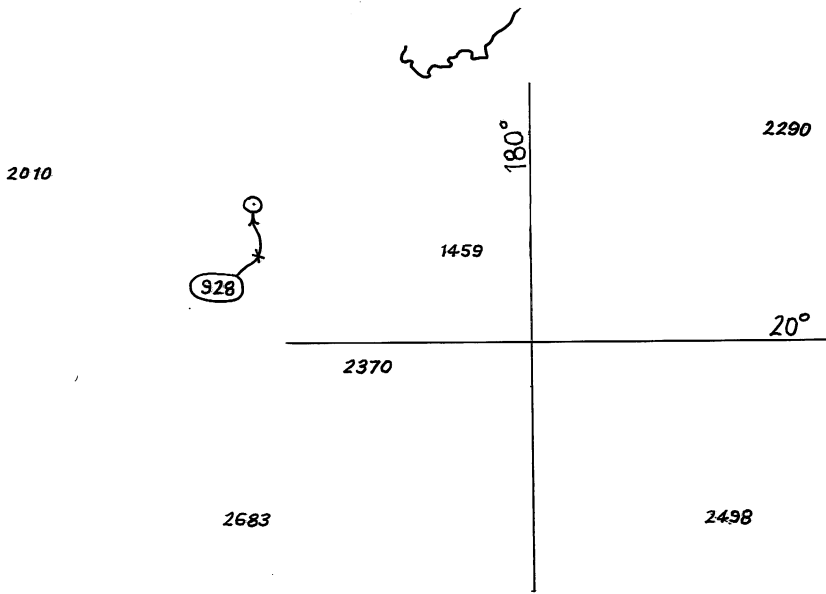

256/2009

1005/2009

© Commonwealth of Australia 2009

INT 60
AUS 4060

1850

RIGHT ABOVE CENTRE

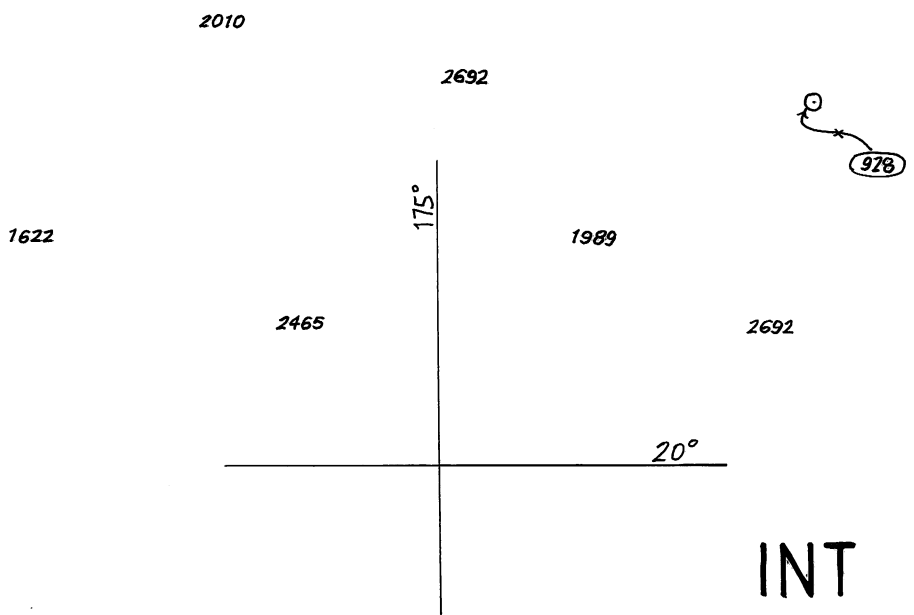

256/2009

1005/2009

© Commonwealth of Australia 2009

INT 602
AUS 4602

1938
1850

RIGHT BELOW CENTRE

2010
3062

928

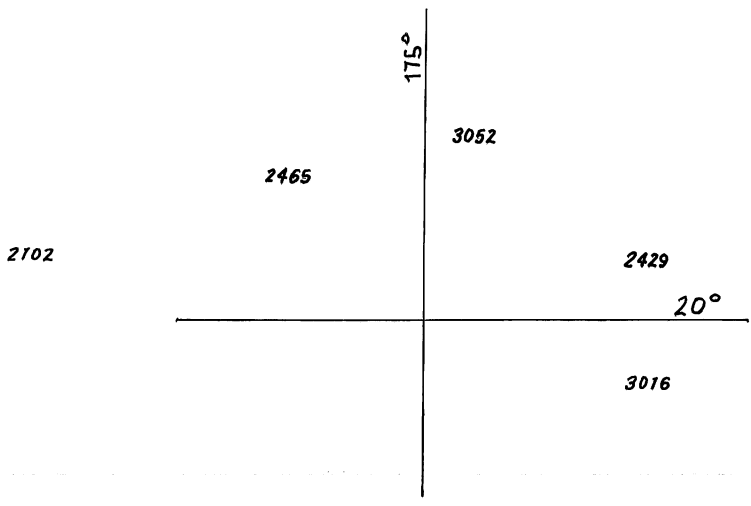

991/2009

1005/2009

© Commonwealth of Australia 2009

INT 604
AUS 4604