

PLAN:
CAMDEN HAVEN

747/2009

932/2009

© Commonwealth of Australia 2009

AUS 219

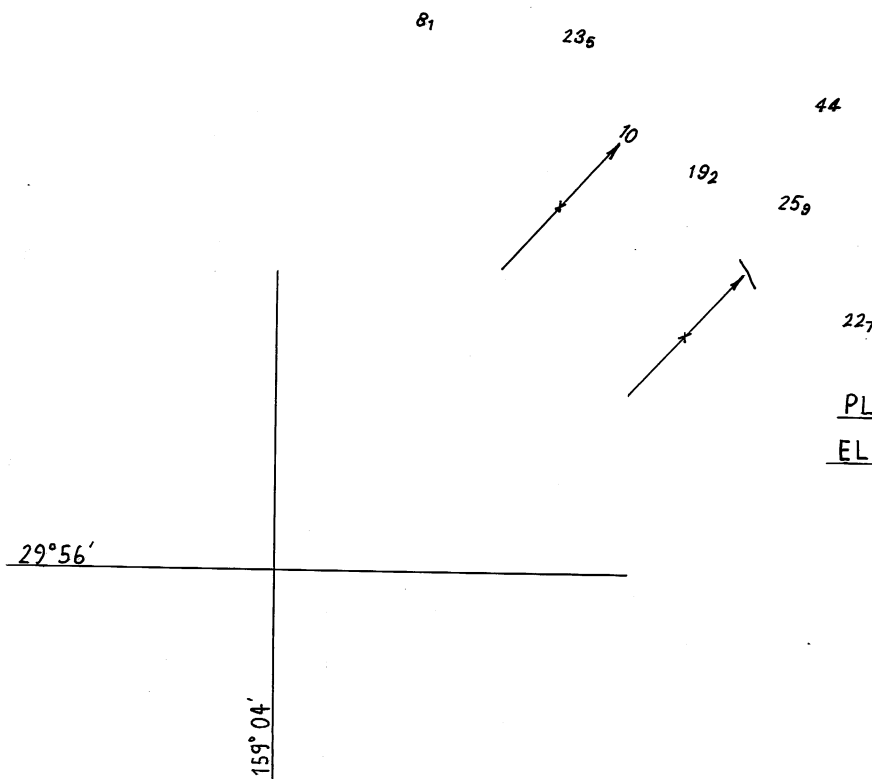

PLAN:
ELIZABETH REEF

114/2006

933/2009

© Commonwealth of Australia 2009

AUS 618

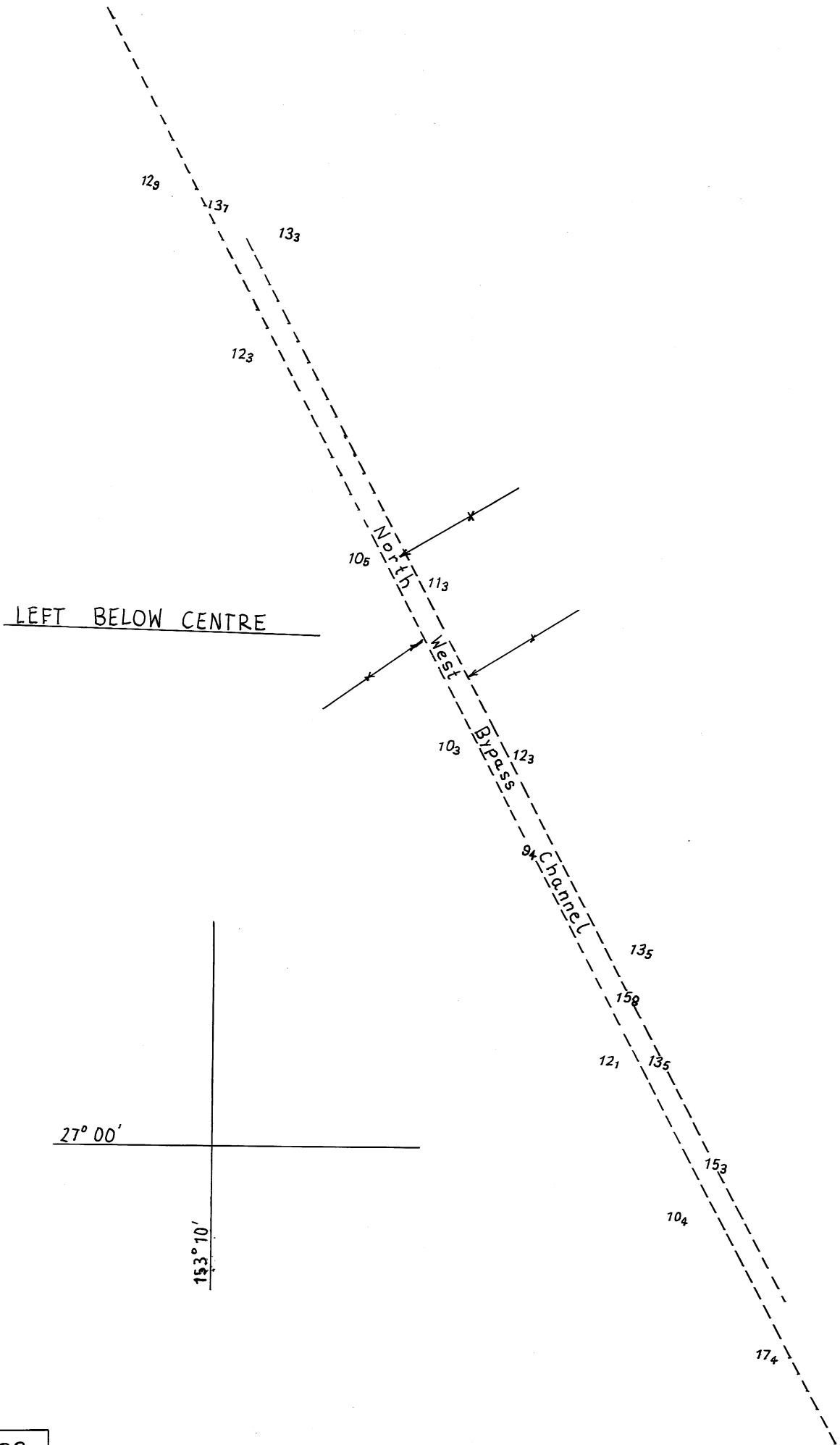

813/2009

934/2009

© Commonwealth of Australia 2009

AUS 235

LEFT ABOVE CENTRE

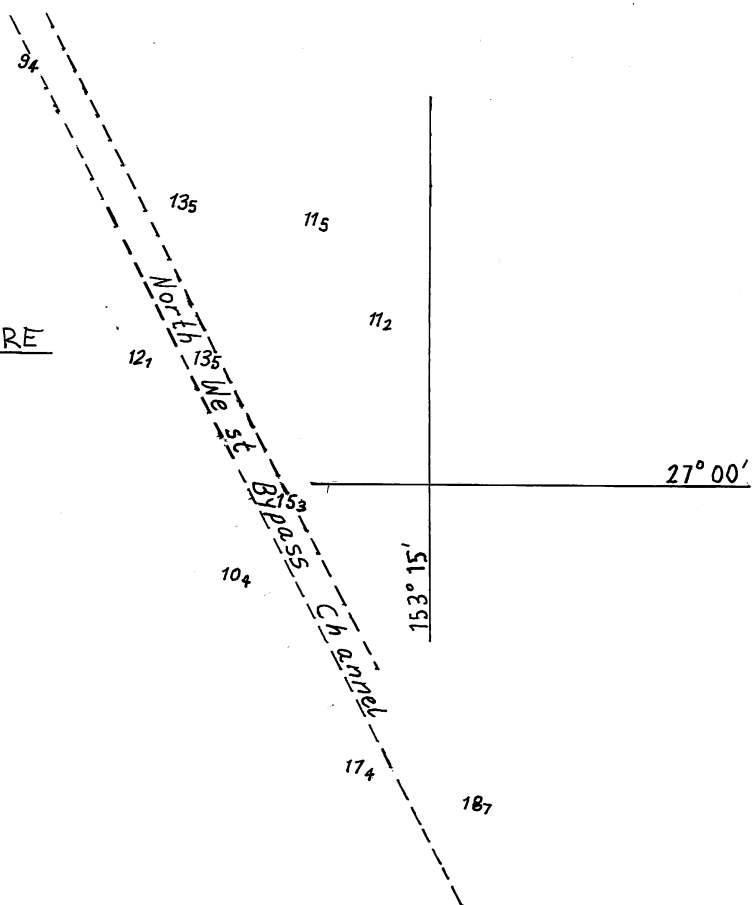

813/2009

934/2009

© Commonwealth of Australia 2009

AUS 236

LEFT ABOVE CENTRE

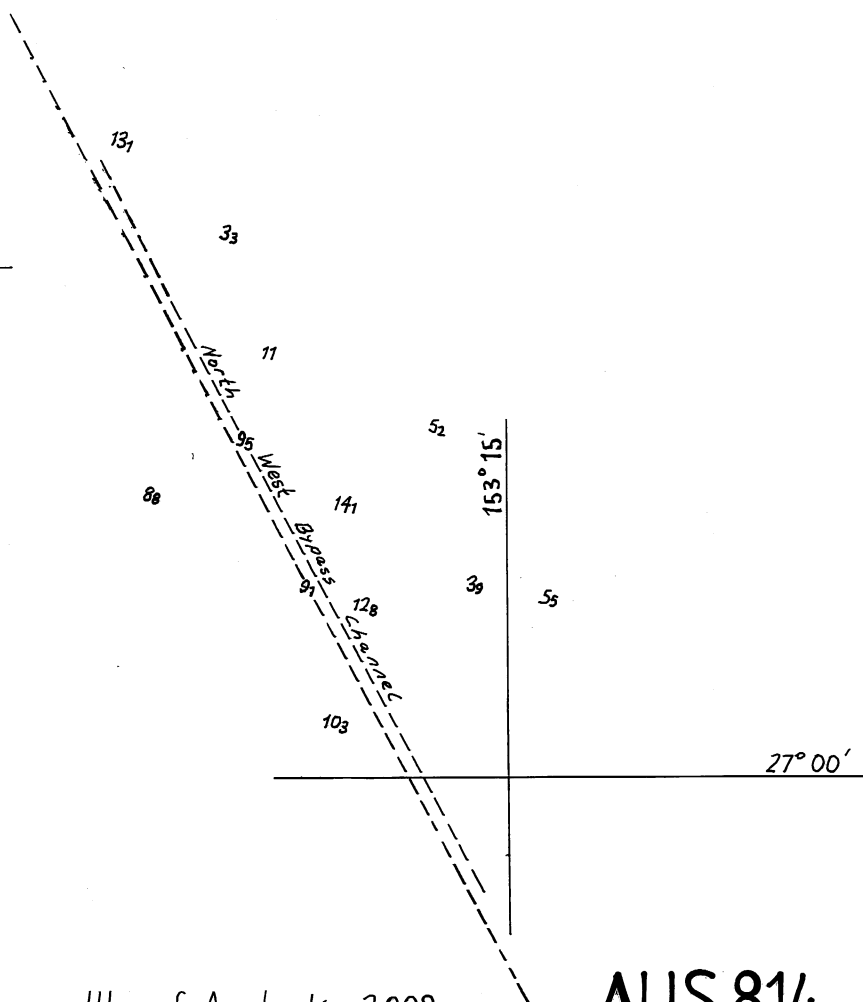

813/2009

934/2009

© Commonwealth of Australia 2009

AUS 814

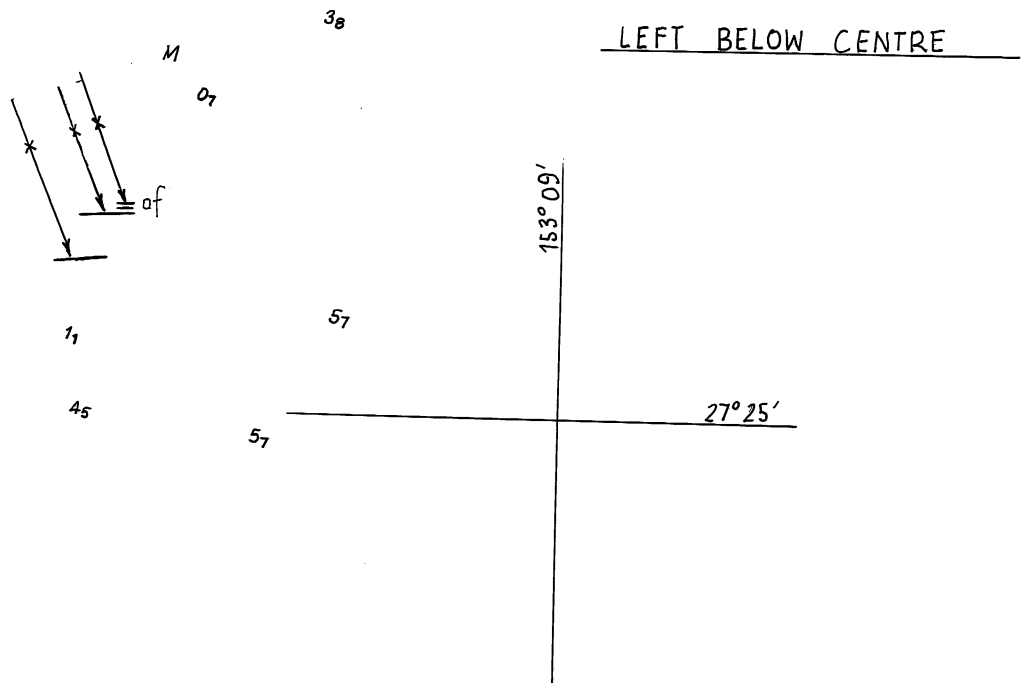

750/2009

935/2009

© Commonwealth of Australia 2009

AUS 237

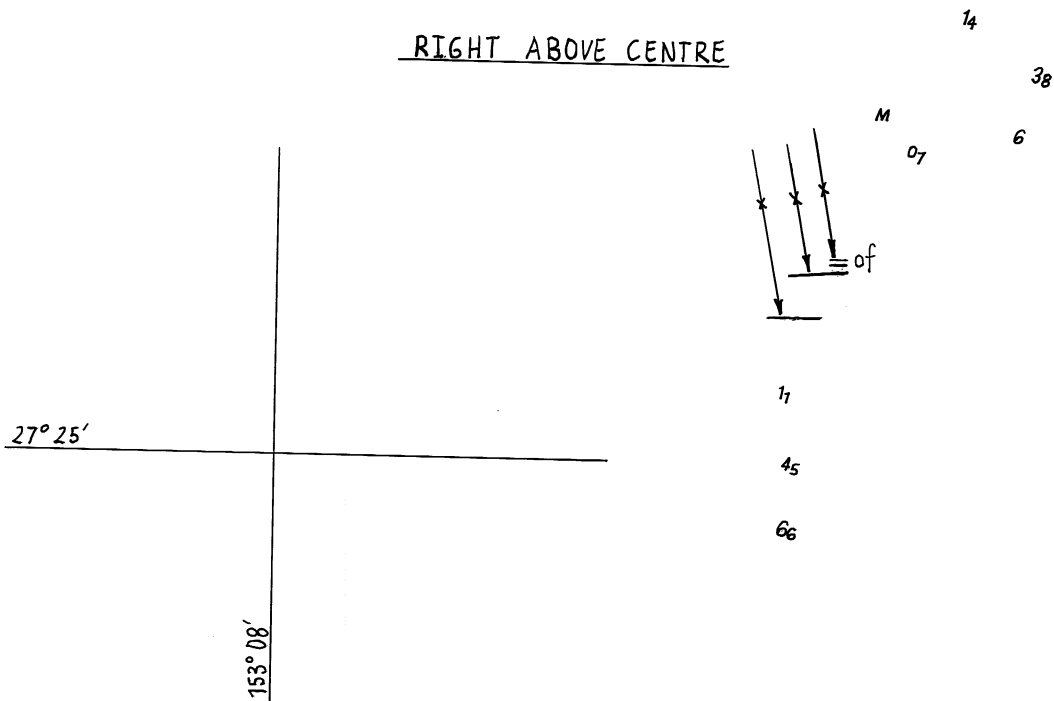

239/2009

935/2009

© Commonwealth of Australia 2009

AUS 238

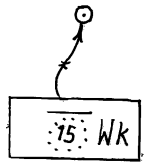

31

267

RIGHT BELOW CENTRE

237

29

233

153° 10'

204

182

25° 55'

860/2009

936/2009

© Commonwealth of Australia 2009

AUS 240

LEFT BELOW CENTRE

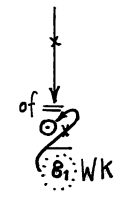

26° 00'

153° 00'

814/2009

936/2009

© Commonwealth of Australia 2009

AUS 365

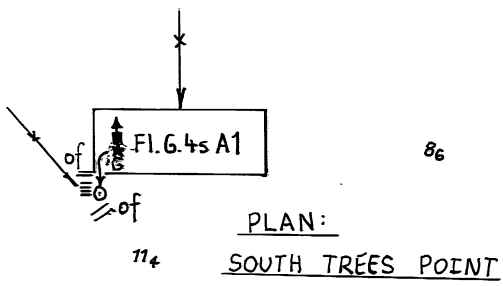

139/2009

937/2009

© Commonwealth of Australia 2009

PLAN:
GLADSTONE AND ADJACENT
WHARVES

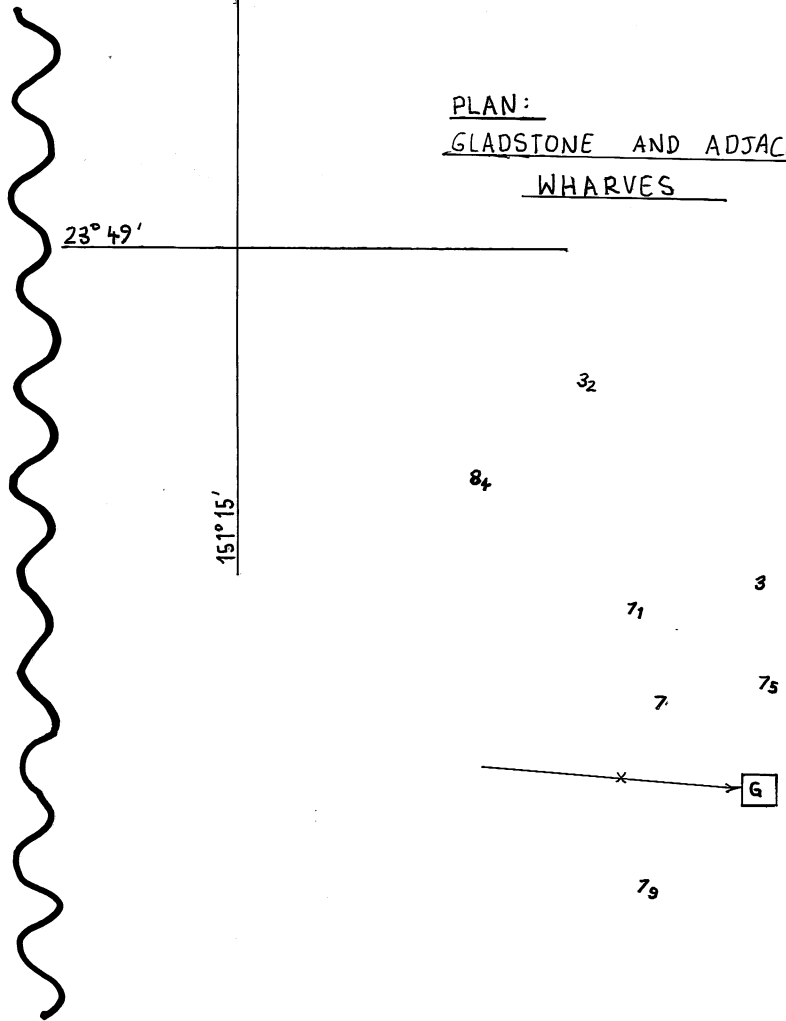

AUS 244

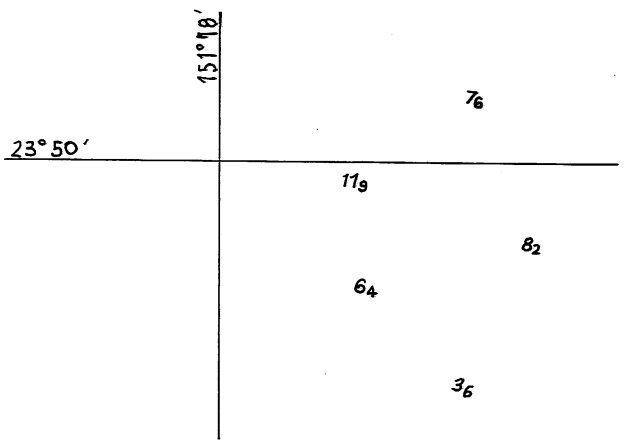

RIGHT BELOW CENTRE

357/2009

937/2009

© Commonwealth of Australia 2009

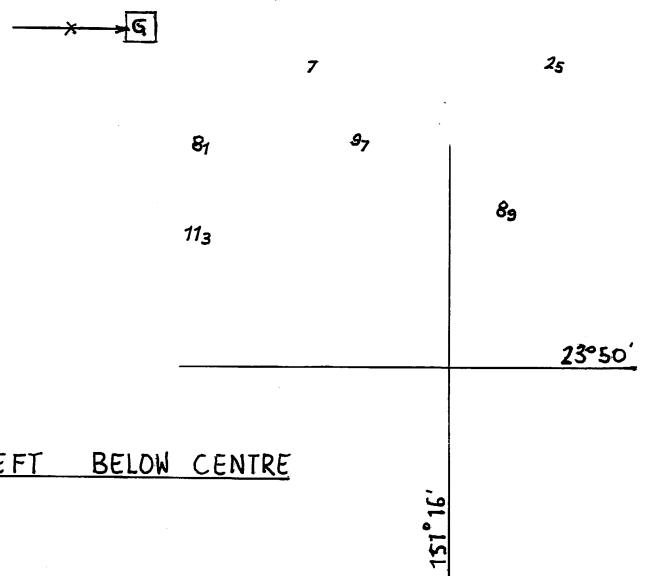

LEFT BELOW CENTRE

AUS 245

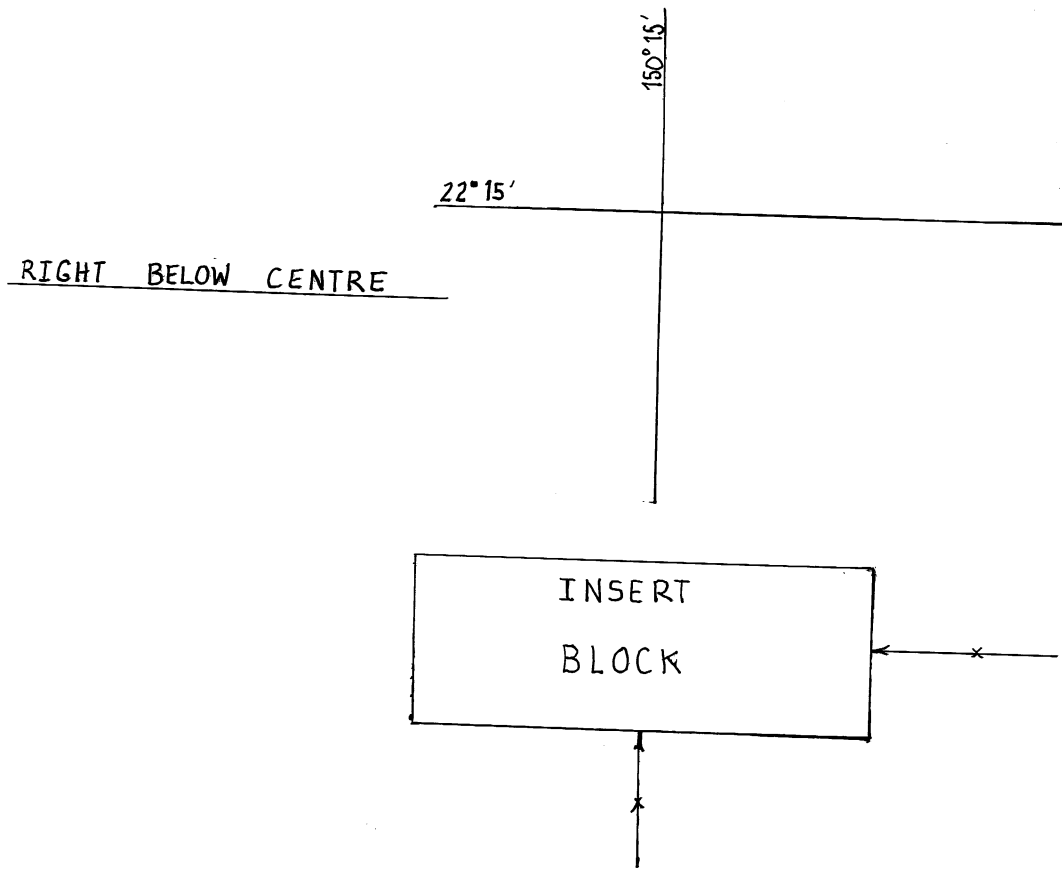

817/2009

938/2009

© Commonwealth of Australia 2009

AUS 822

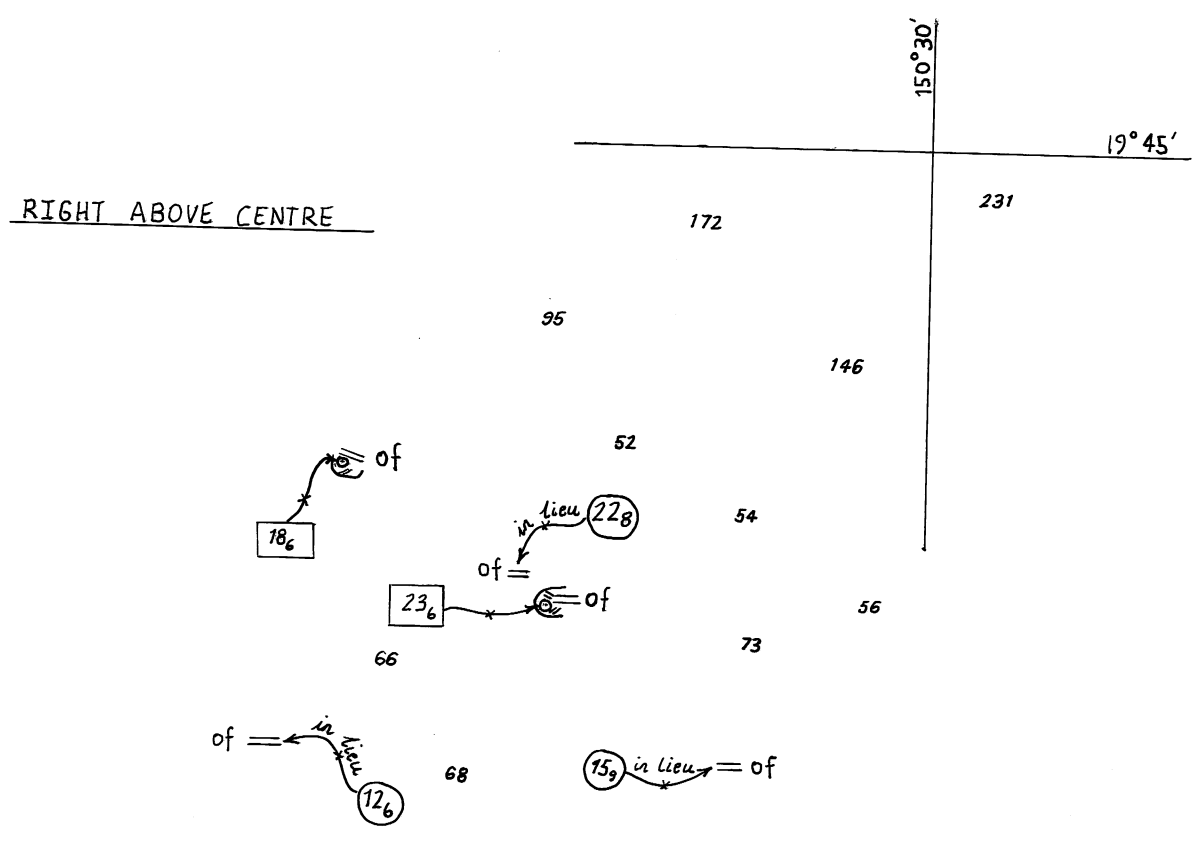

291/2009

939/2009

© Commonwealth of Australia 2009

AUS 821

RIGHT BELOW CENTRE

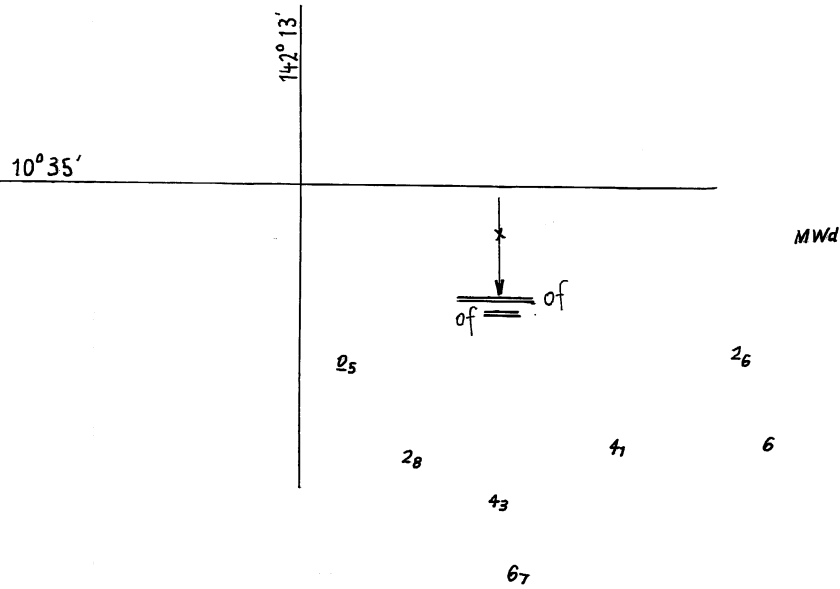

703/2009

940/2009

© Commonwealth of Australia 2009

AUS 299

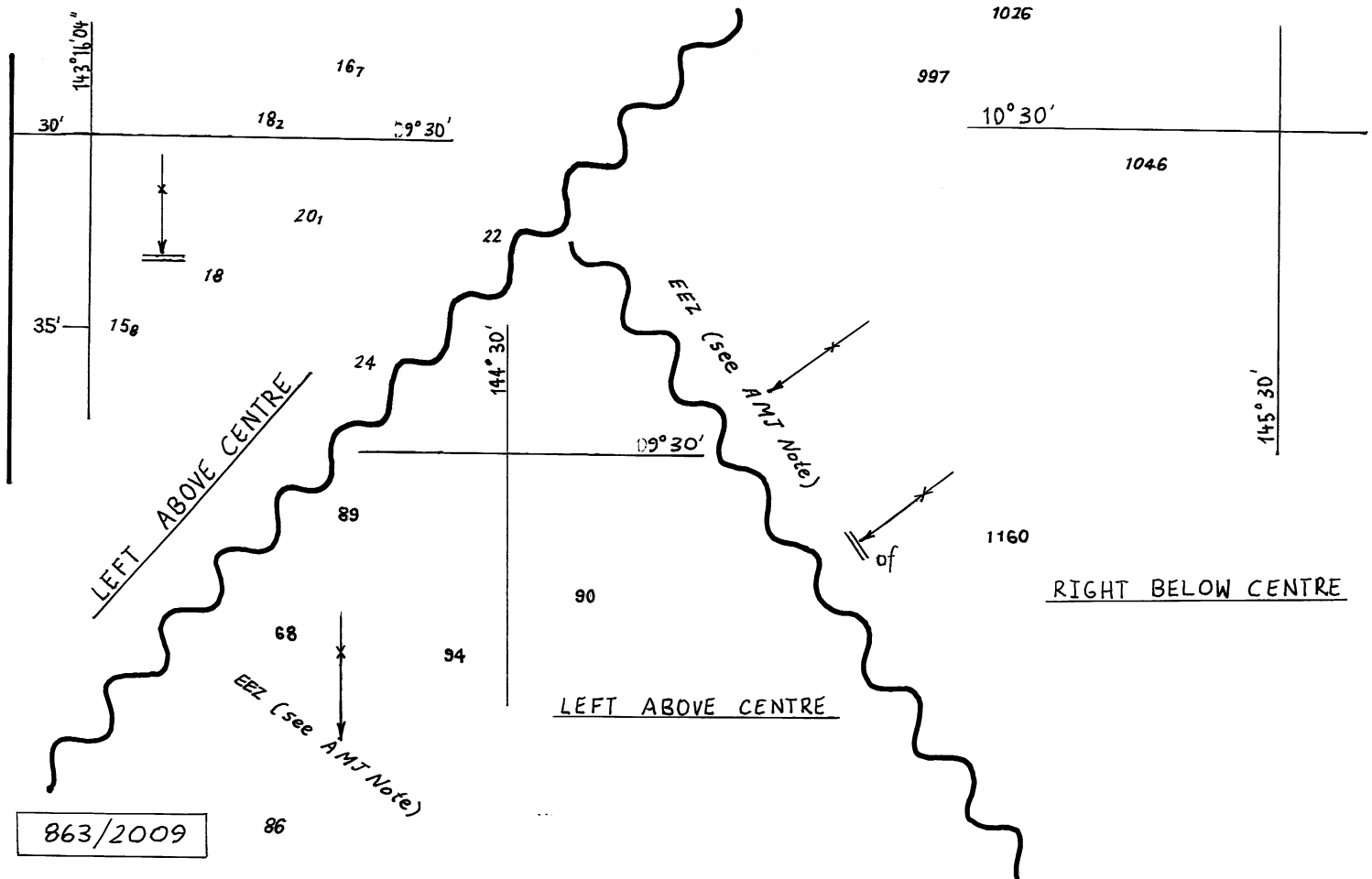

863/2009

941/2009

© Commonwealth of Australia 2009

AUS 377

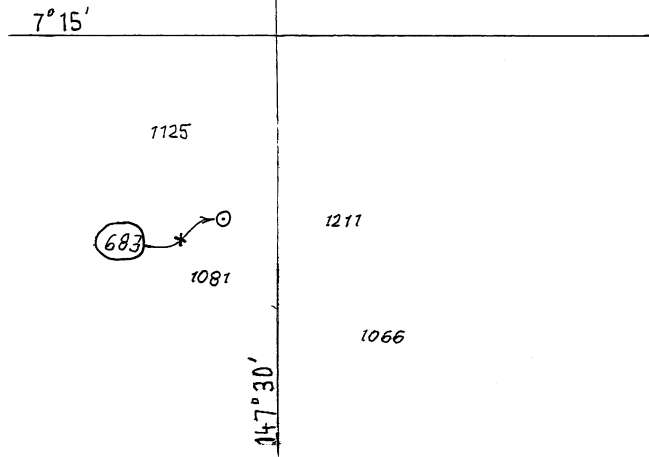

LEFT ABOVE CENTRE

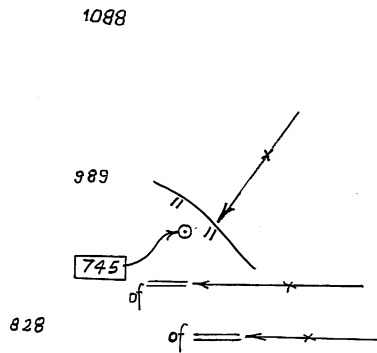

597 / 2007

942 / 2009

© Commonwealth of Australia 2009

AUS 522

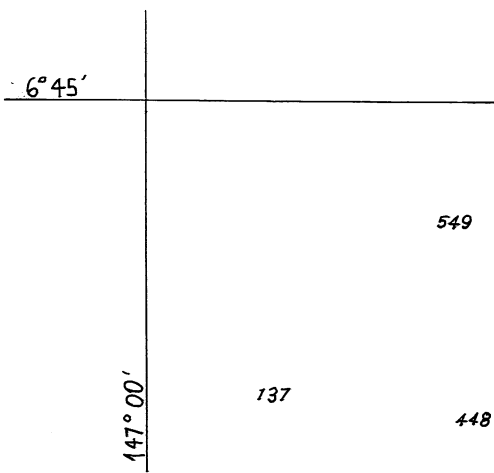

LEFT ABOVE CENTRE

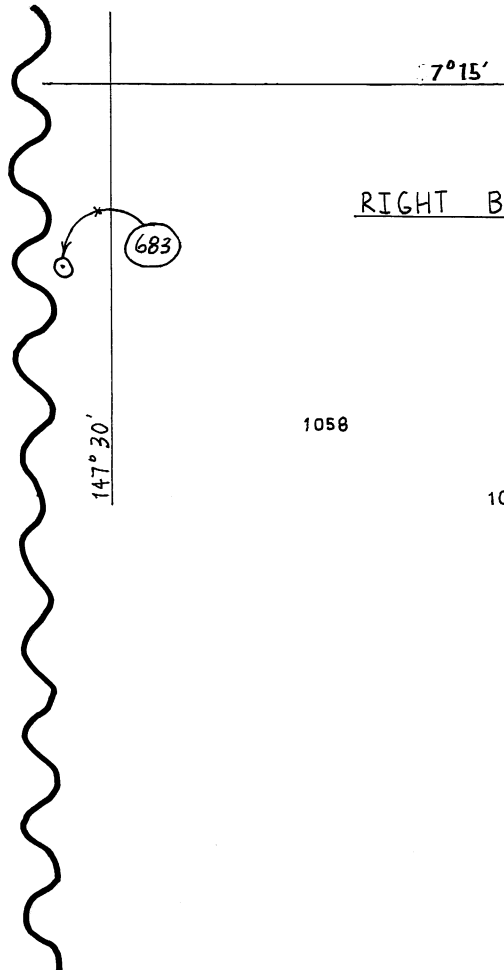

RIGHT BELOW CENTRE

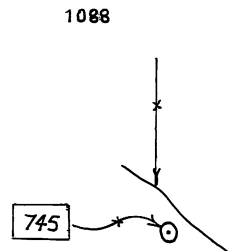

45 / 2009

942 / 2009

© Commonwealth of Australia 2009

AUS 523

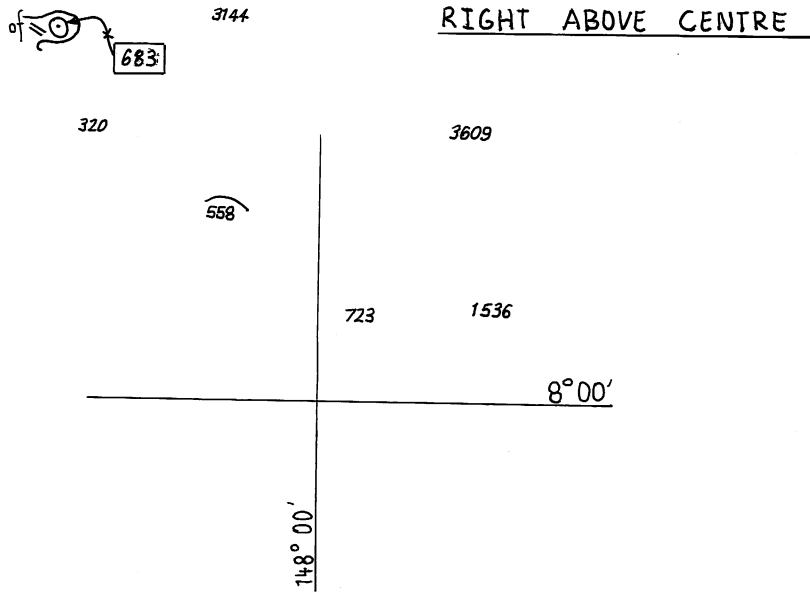

864/2009

942/2009

© Commonwealth of Australia 2009

INT 620
AUS 4620

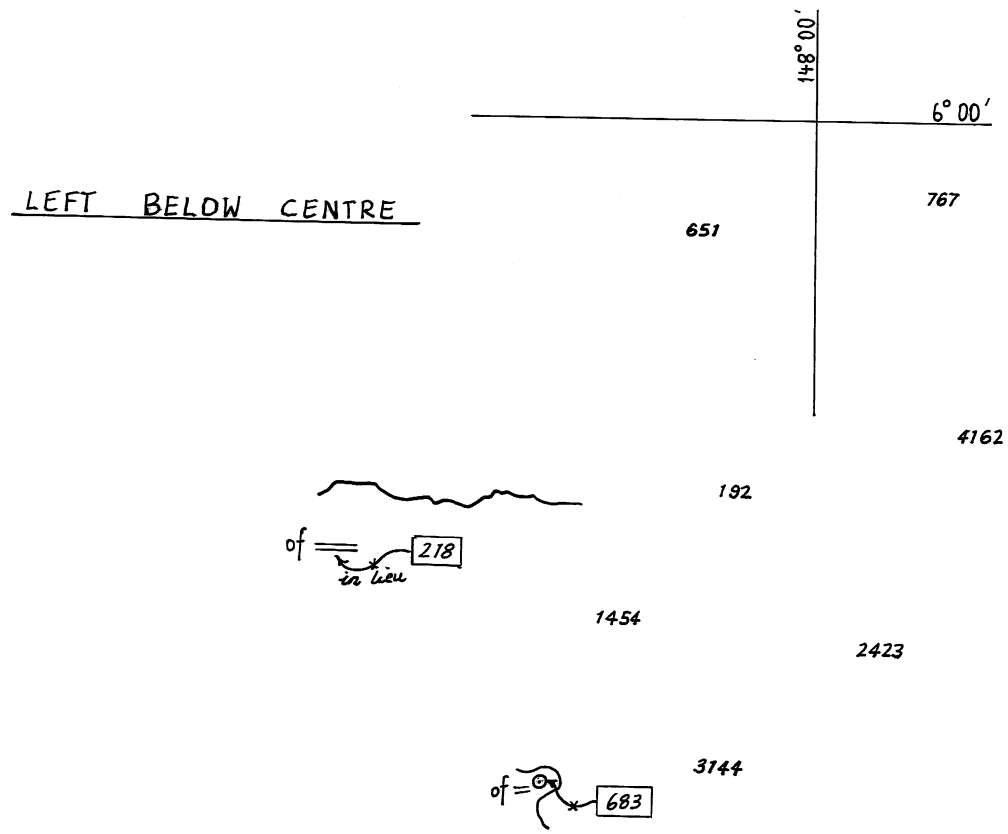

539/2009

942/2009

© Commonwealth of Australia 2009

INT 622
AUS 4622

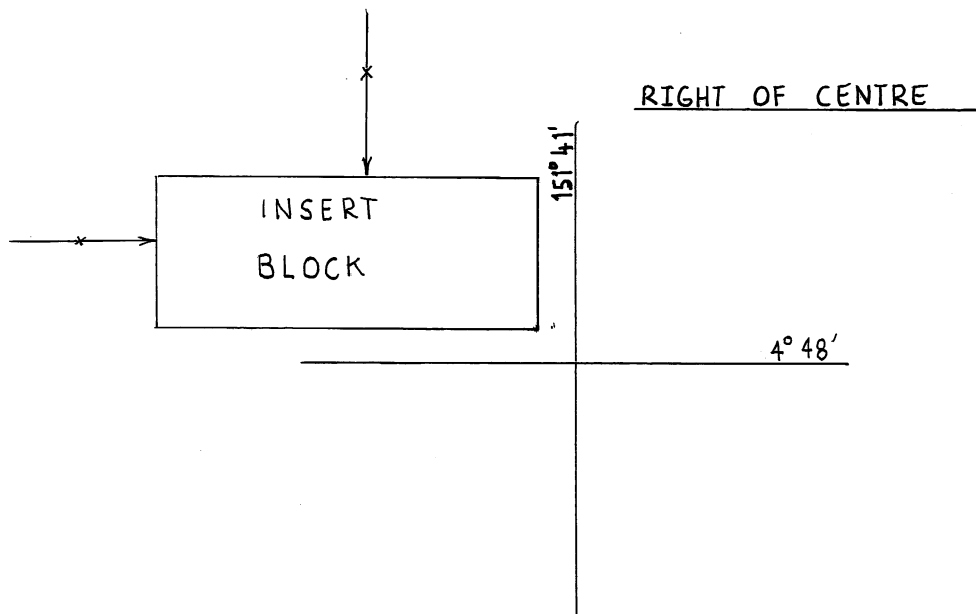

NC 27/2/2009

943/2009

© Commonwealth of Australia 2009

AUS 672

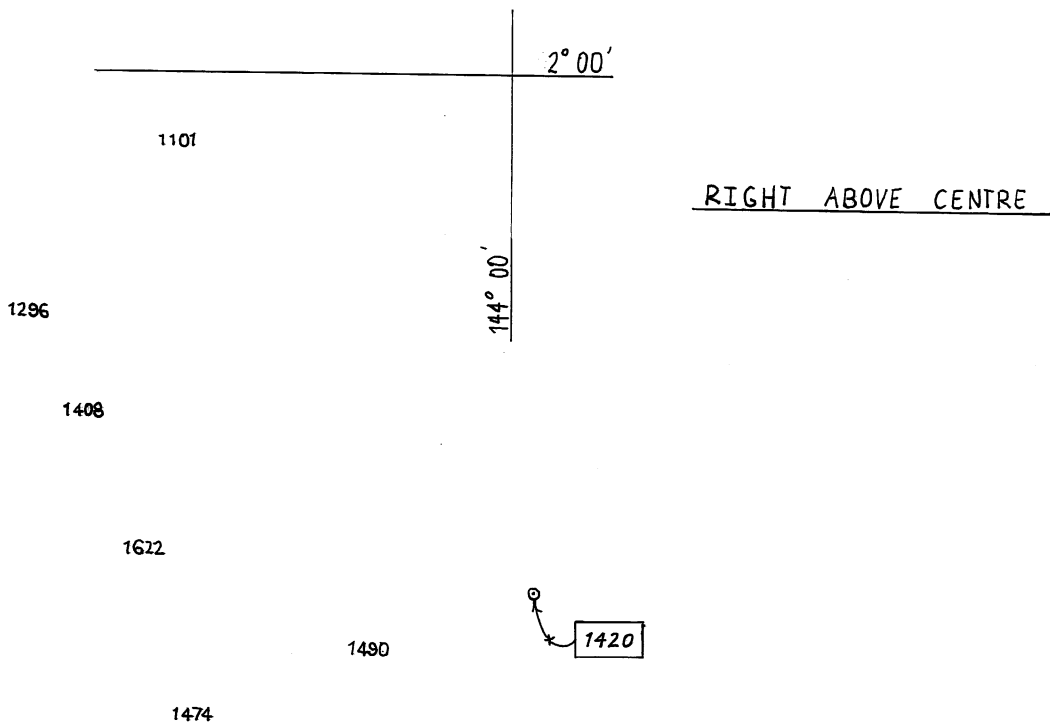

NC 28/3/2008

944/2009

© Commonwealth of Australia 2009

AUS 389

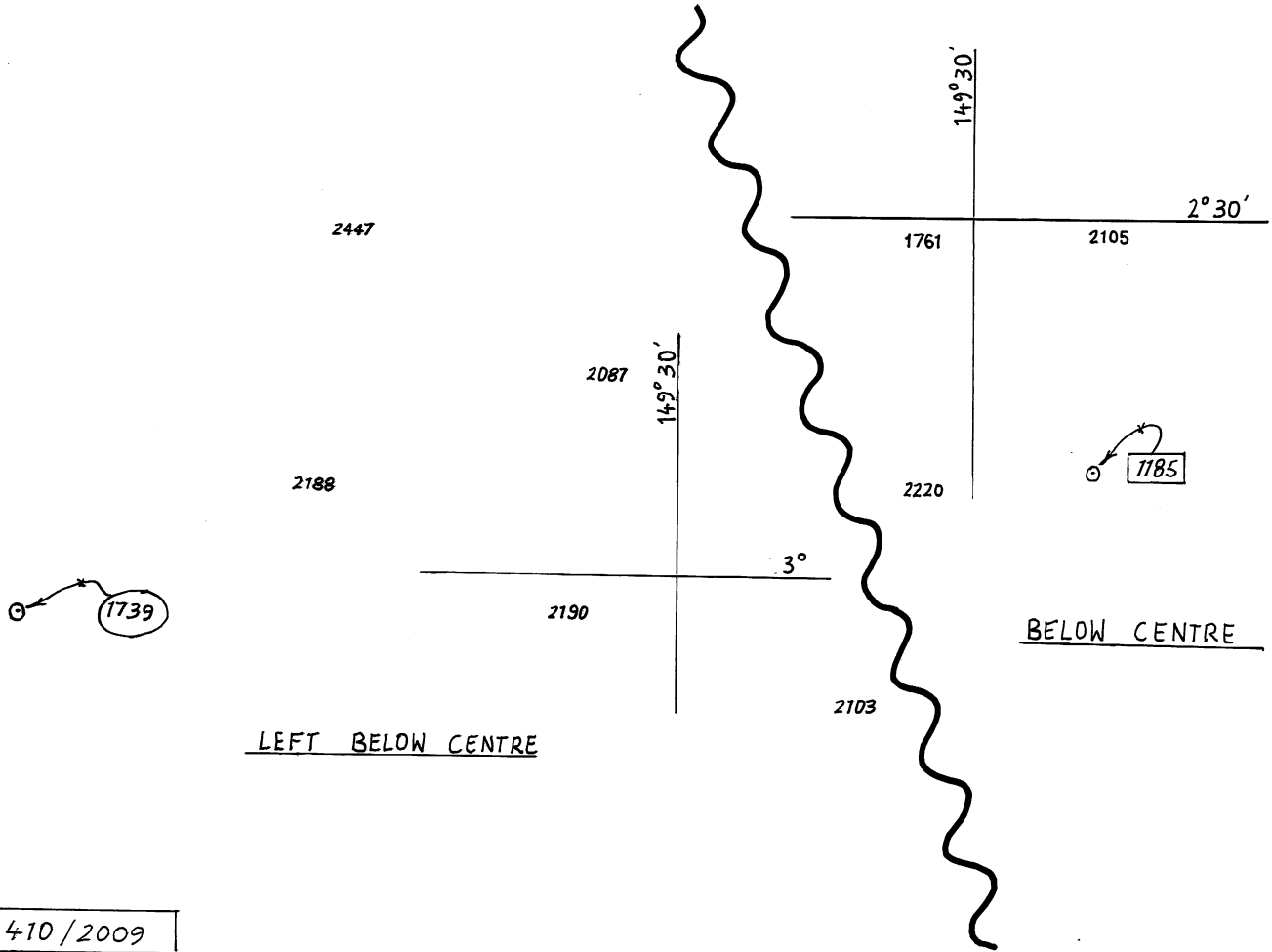

410/2009

944/2009

© Commonwealth of Australia 2009

AUS 392

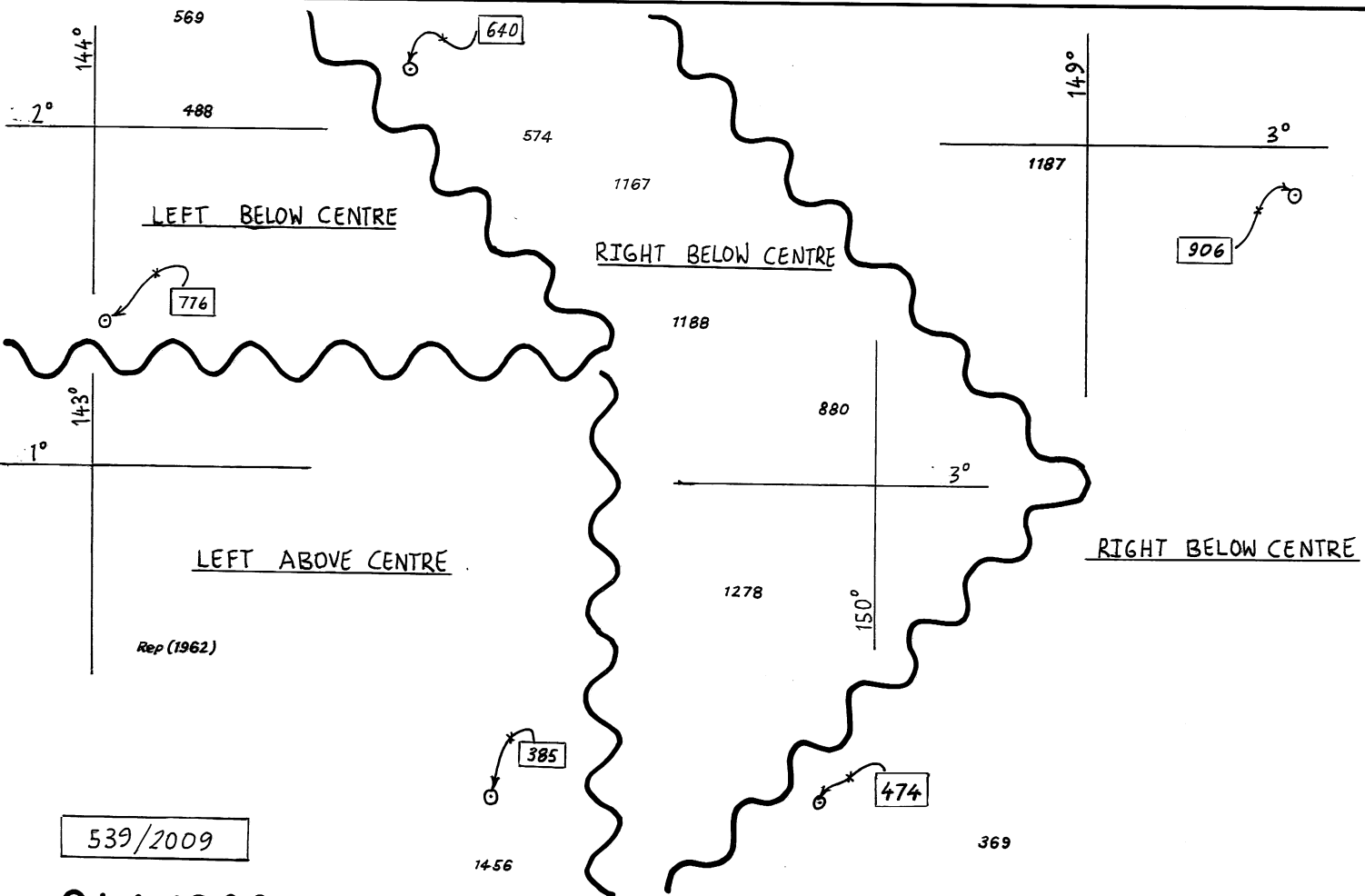

539/2009

944/2009

© Commonwealth of Australia 2009

AUS 462

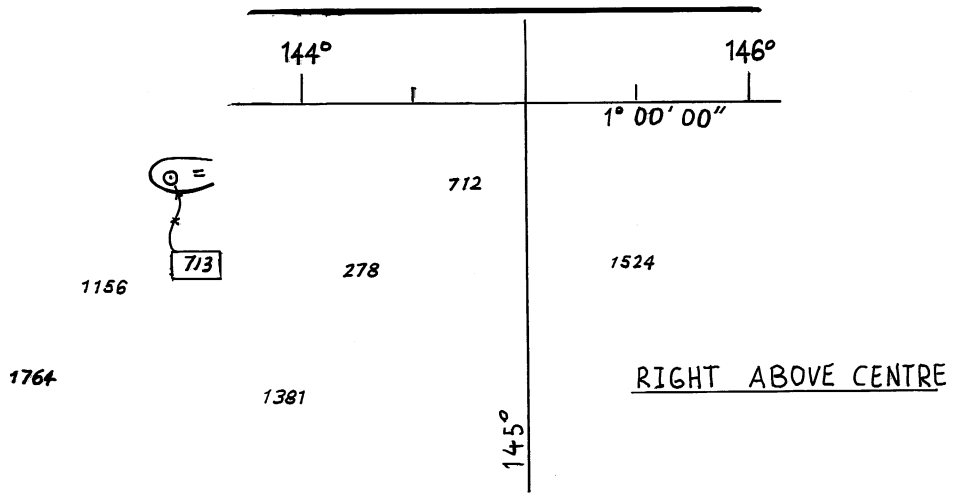

868/2009

944/2009

© Commonwealth of Australia 2009

INT 603
AUS 4603

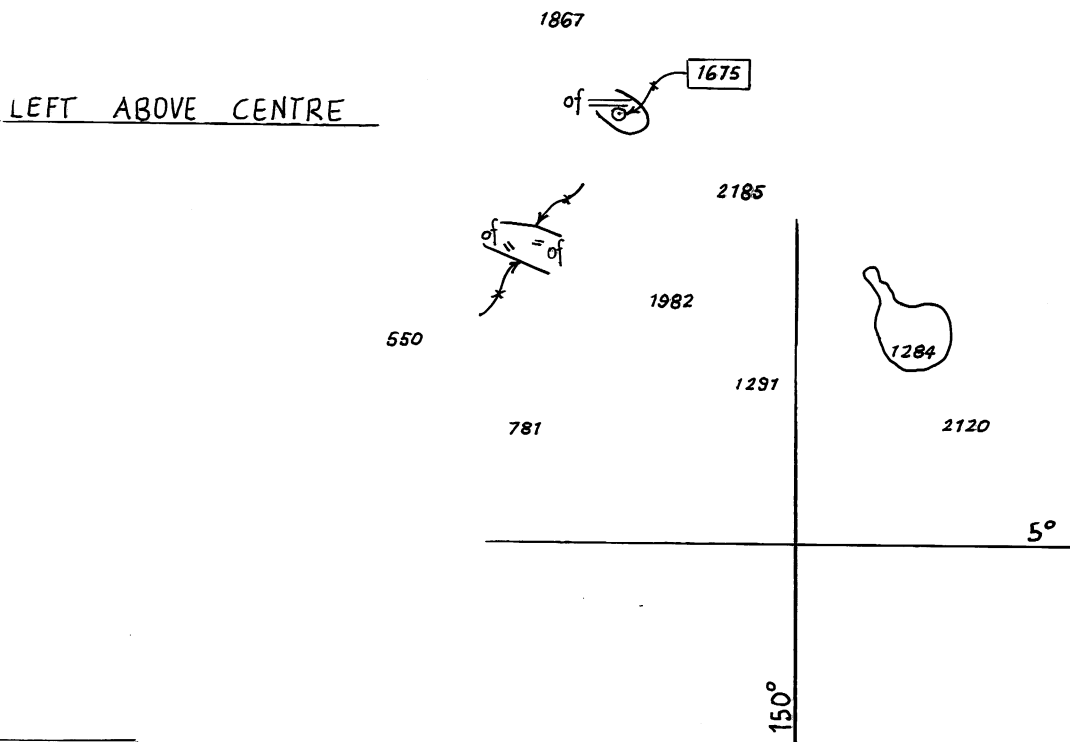

755/2009

944/2009

© Commonwealth of Australia 2009

INT 604
AUS 4604

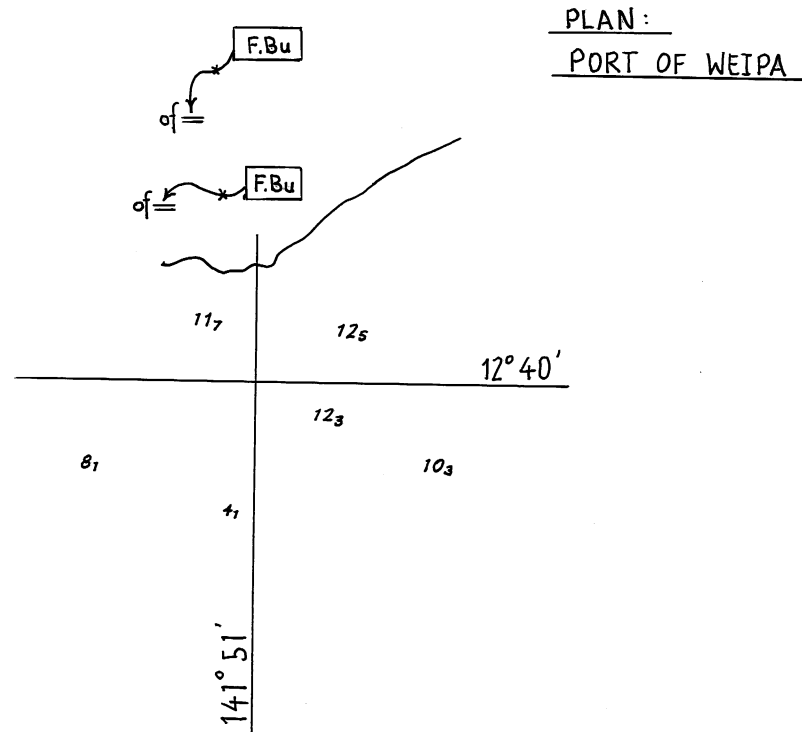
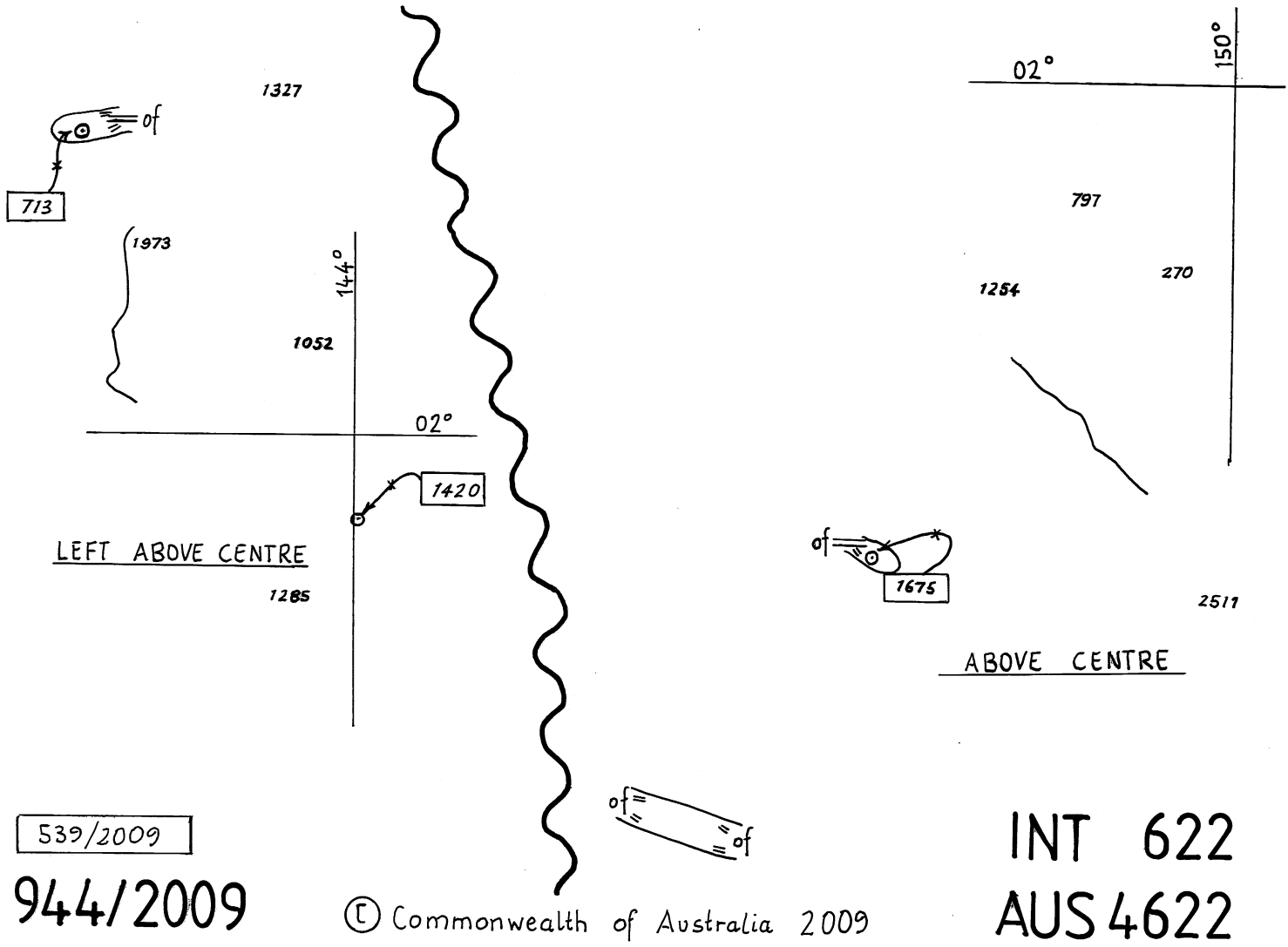

PLAN:

GOVE HARBOUR

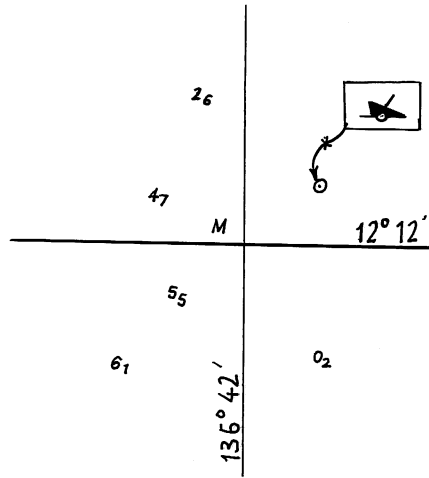

245/2009

946/2009

© Commonwealth of Australia 2009

AUS 15

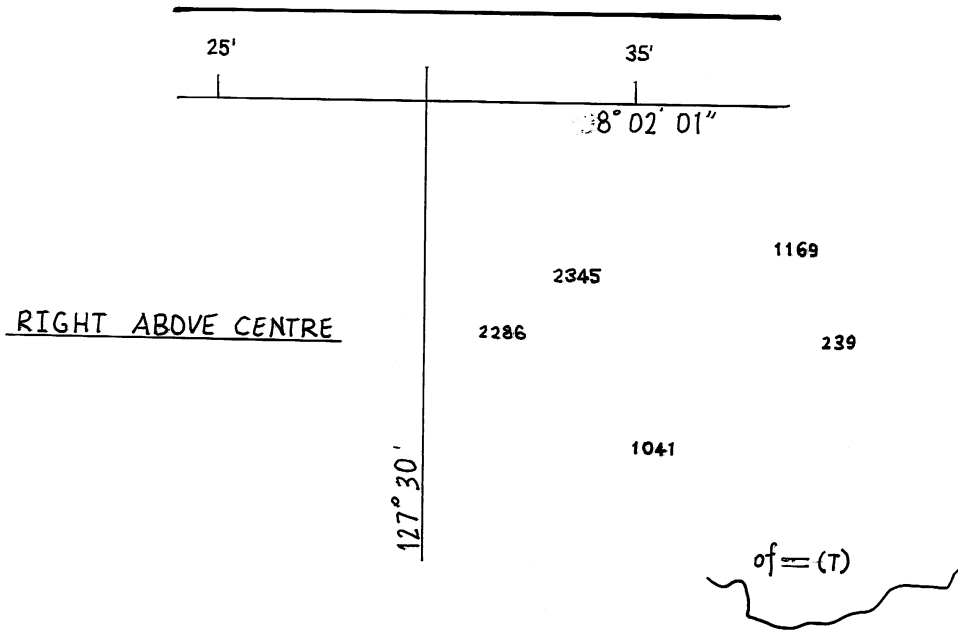

648/2009

947/2009

© Commonwealth of Australia 2009

AUS 313

PLAN:
PORT OF BUNBURY

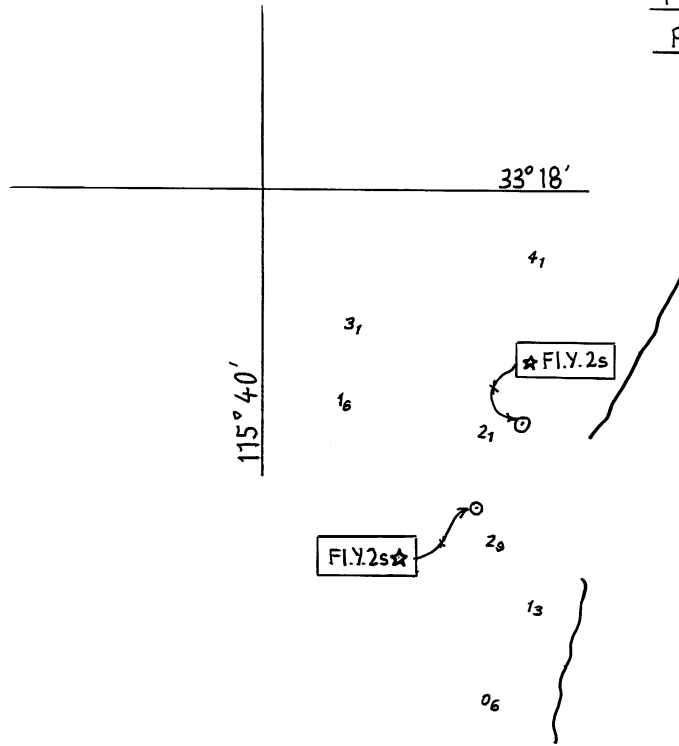

254/2009

948/2009

© Commonwealth of Australia 2009

AUS 115

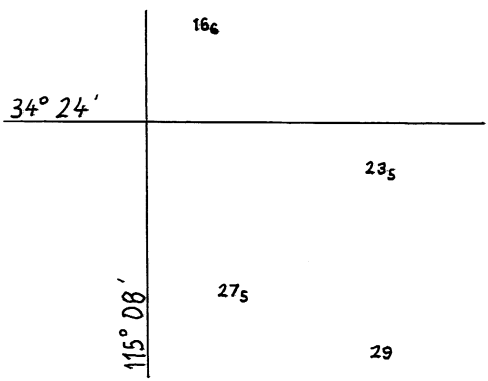

of of
30s Historic Wk
(see Note)

PLAN:
FLINDERS BAY

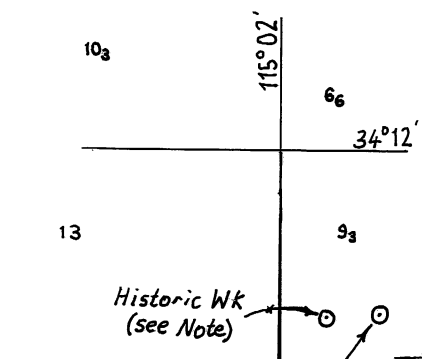

Historic Wk
(see Note)

PLAN:
HAMELIN BAY

Historic Wks
(see Note)

872/2009

949/2009

© Commonwealth of Australia 2009

AUS 116

RIGHT BELOW CENTRE

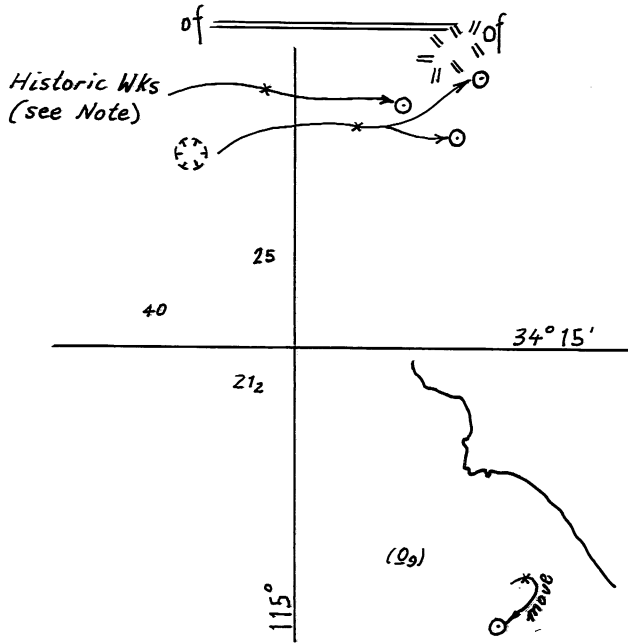

NE 16/1/2009

949/2009

© Commonwealth of Australia 2009

RIGHT BELOW CENTRE

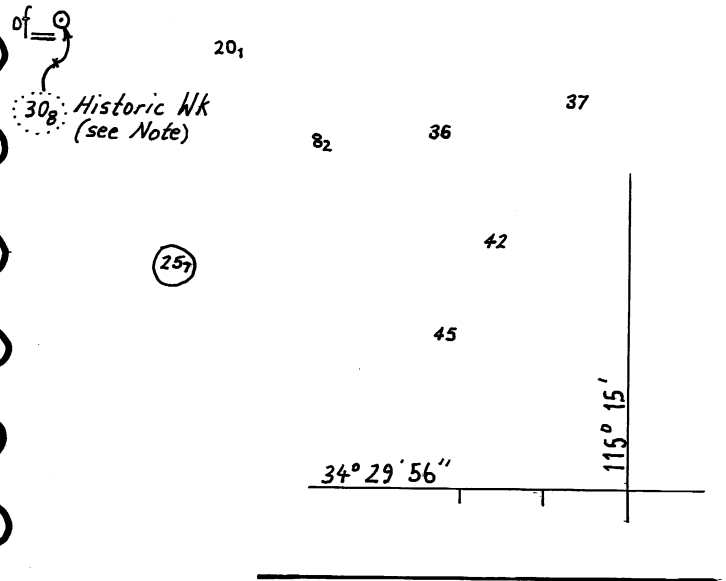

AUS 756

LEFT ABOVE CENTRE

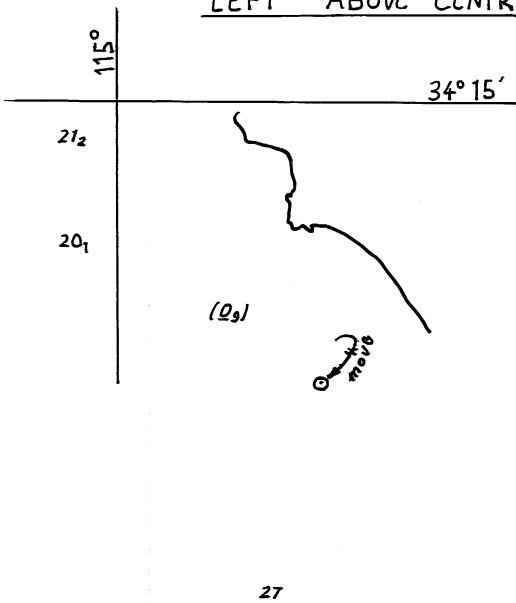

NE 16/1/2009

949/2009

© Commonwealth of Australia 2009

LEFT ABOVE CENTRE

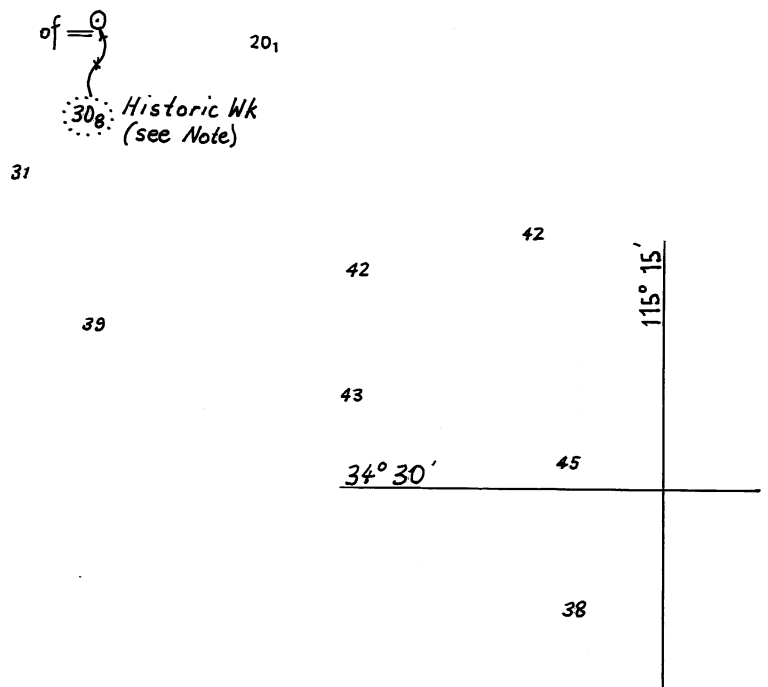

AUS 757

PLAN :

BANDY CREEK BOAT HARBOUR

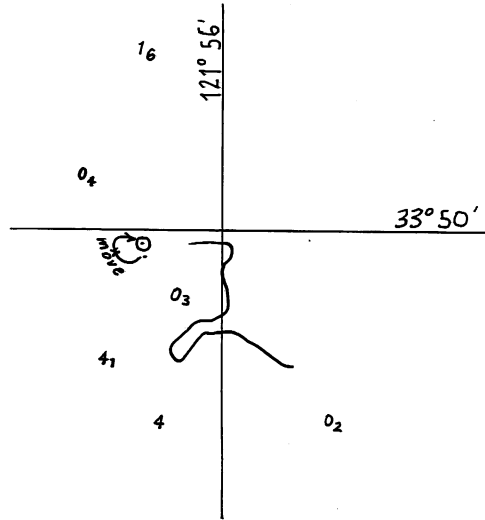

875/2009

950/2009

© Commonwealth of Australia 2009

AUS 119

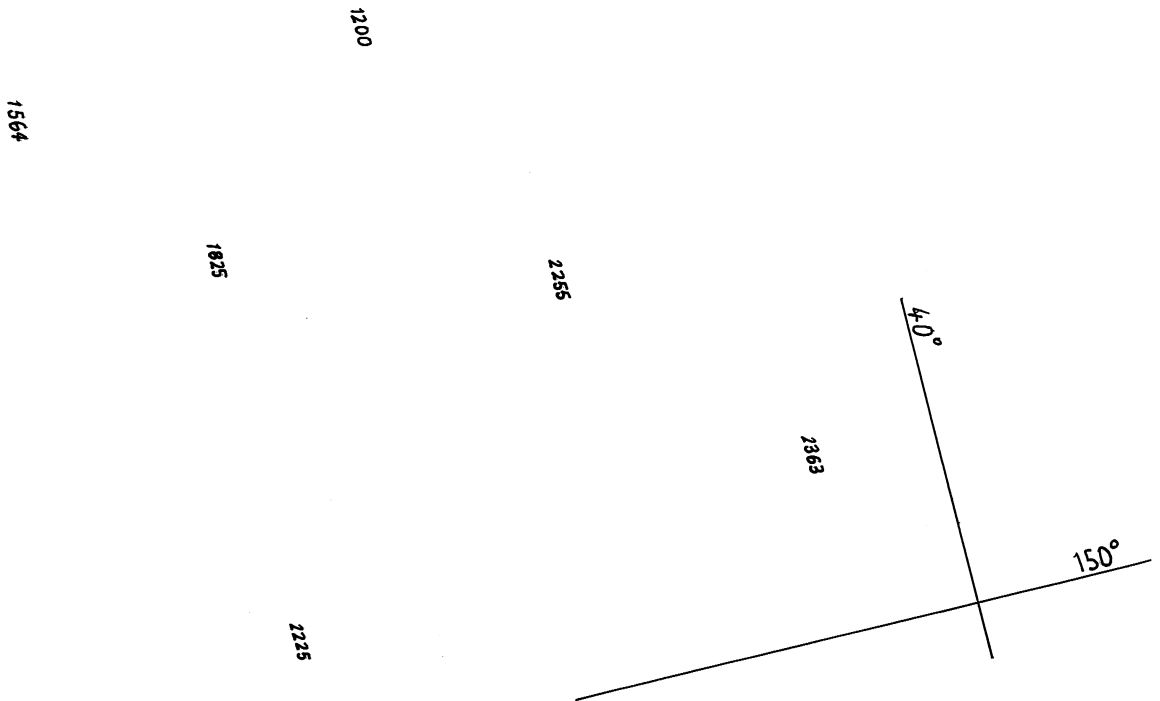

612/2009

951/2009

© Commonwealth of Australia 2009

AUS 422

LEFT BELOW CENTRE

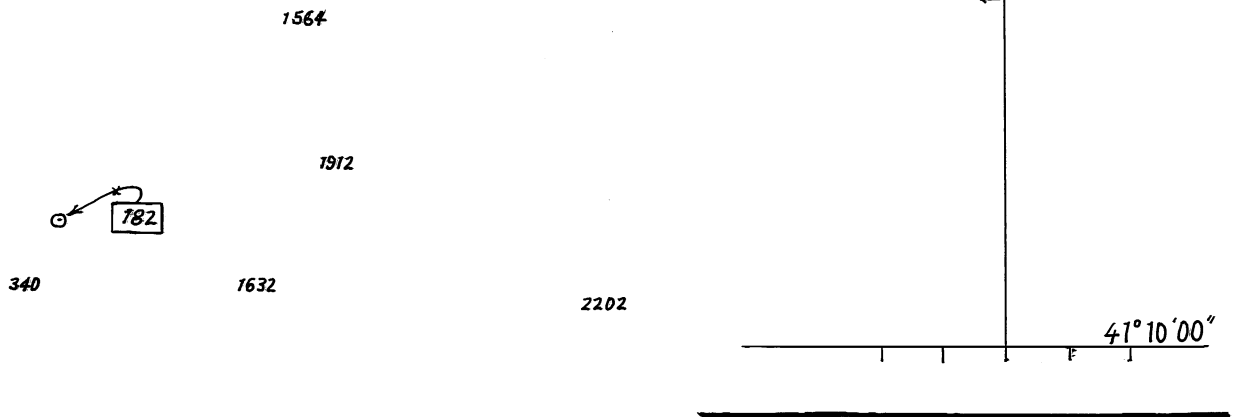

805/2009

951/2009

© Commonwealth of Australia 2009

AUS 423

RIGHT BELOW CENTRE

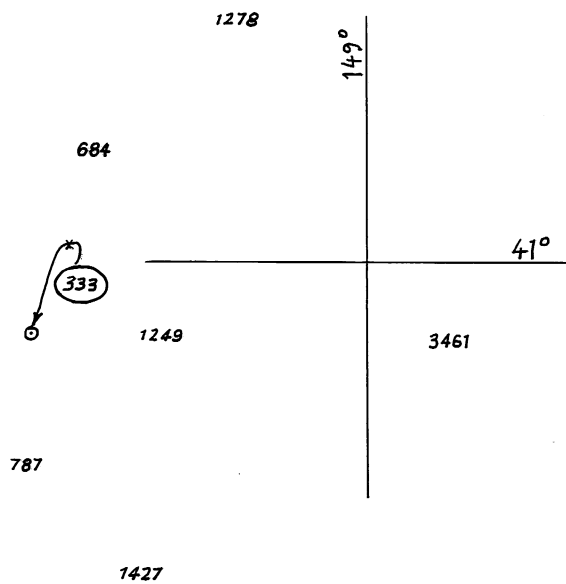

612/2009

951/2009

© Commonwealth of Australia 2009

AUS 487

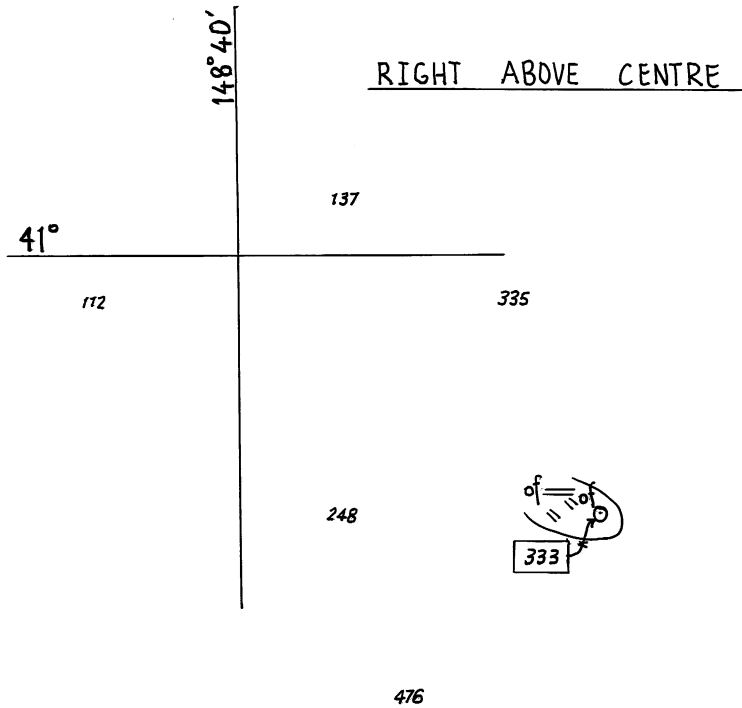

424/2009

951/2009

© Commonwealth of Australia 2009

AUS 767

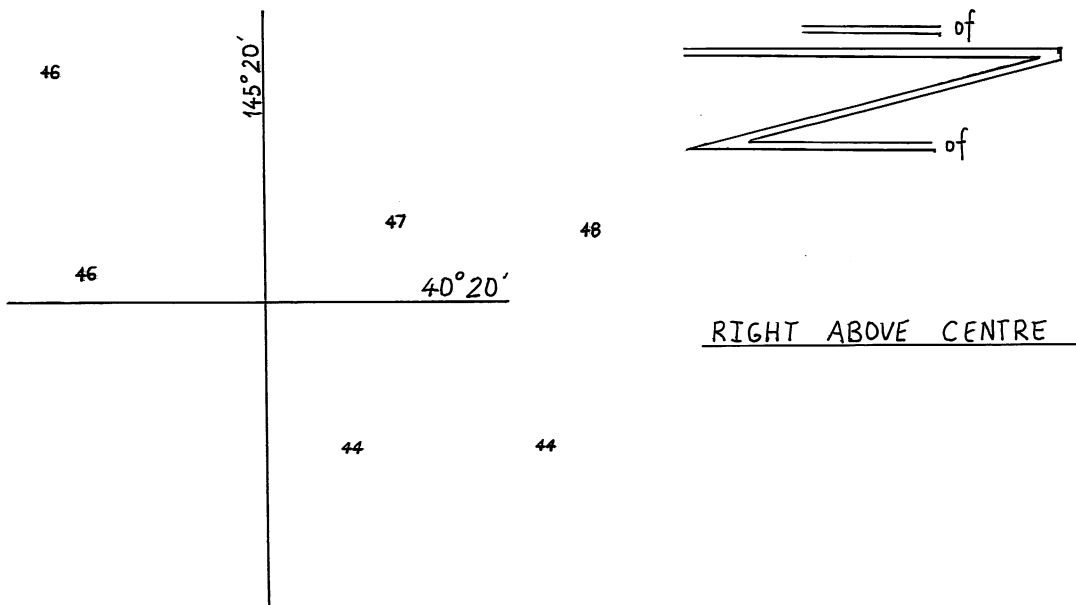

656/2009

952/2009

© Commonwealth of Australia 2009

AUS 790

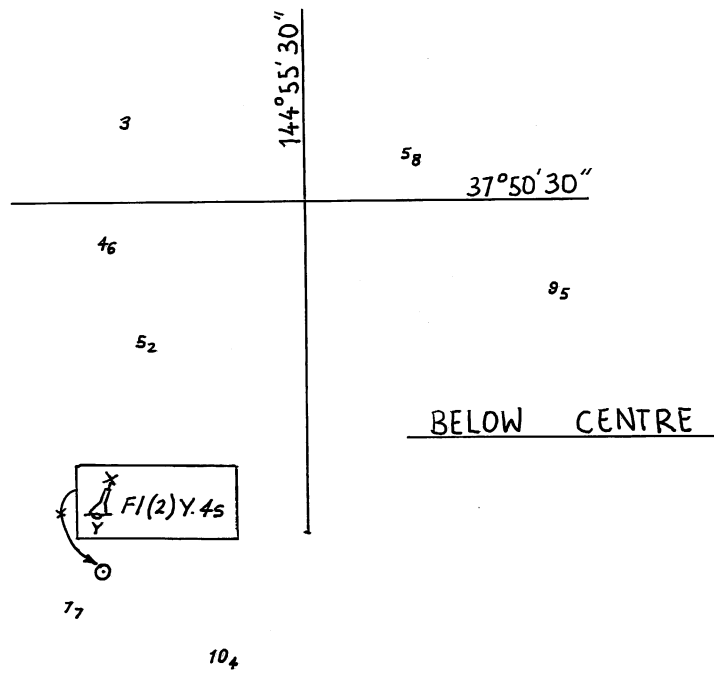

884/2009

953/2009

© Commonwealth of Australia 2009

AUS 154