



16<sub>1</sub>

14<sub>8</sub>

118°30'

15<sub>5</sub>

20°08'

Fl. R. 2s 12m 6M

*in lieu*

of

Fl. G. 2s 13m 6M

\*

\*

15<sub>5</sub>

LEFT ABOVE CENTRE

14<sub>2</sub>

14<sub>7</sub>

14<sub>5</sub>

14<sub>5</sub>

Fl. R. 2s 13m 6M

14<sub>5</sub>

13<sub>9</sub>

Fl. G. 2s 13m 6M

14<sub>4</sub>

*in lieu*

of

*in lieu*

of

862/2005

1029/2006

© Commonwealth of Australia 2006

AUS

F3

52

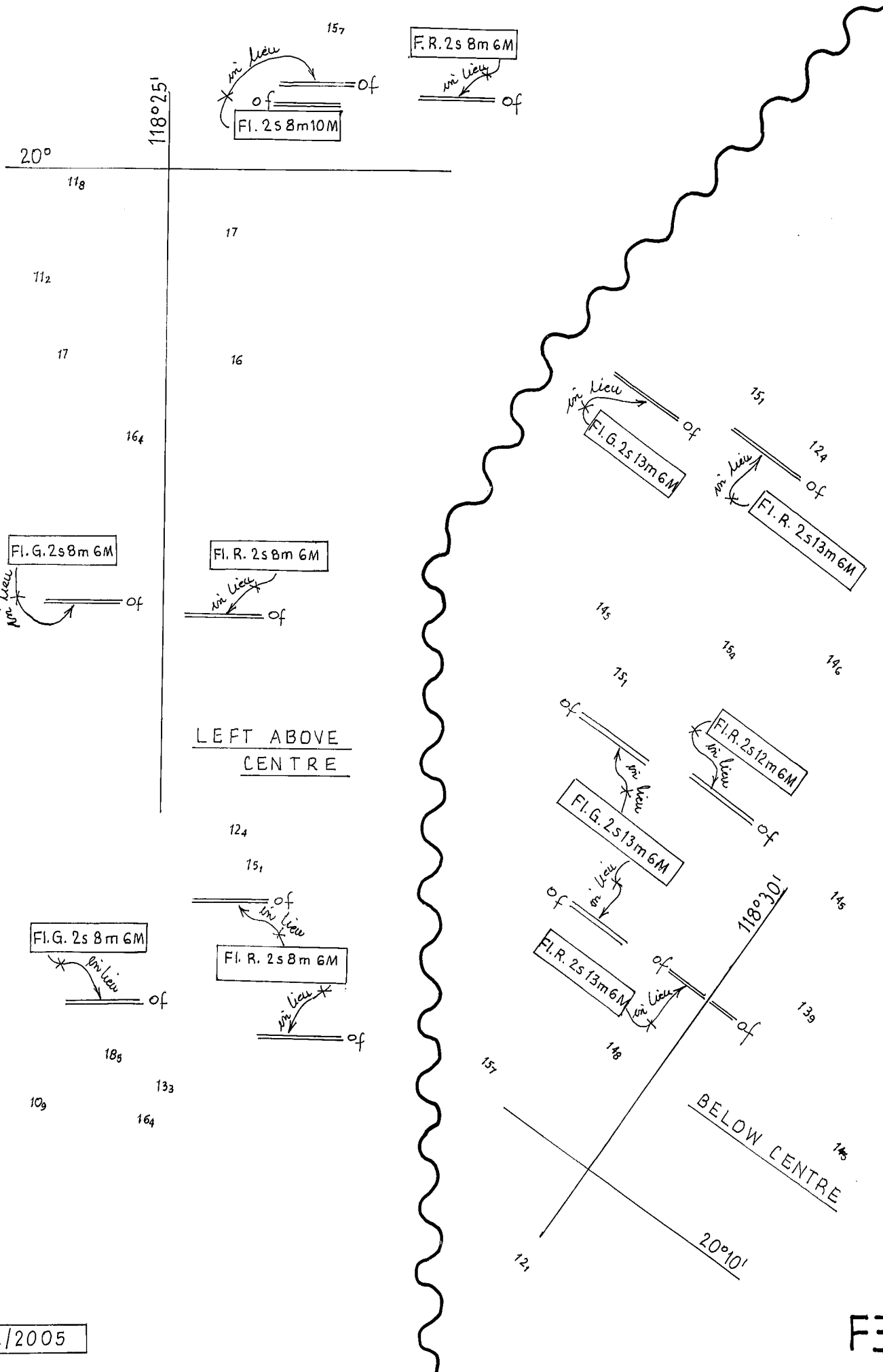

862/2005

1029/2006

© Commonwealth of Australia 2006

F3  
AUS 53

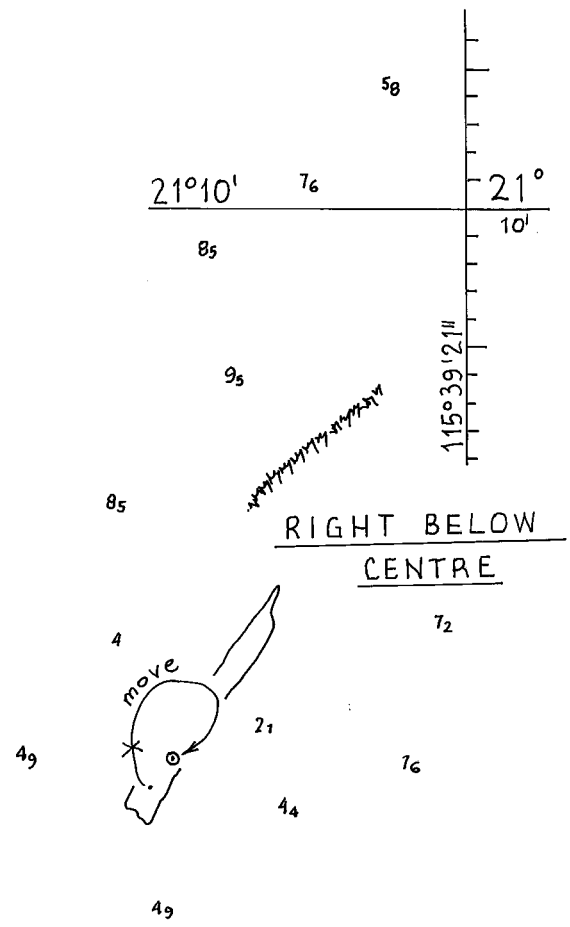
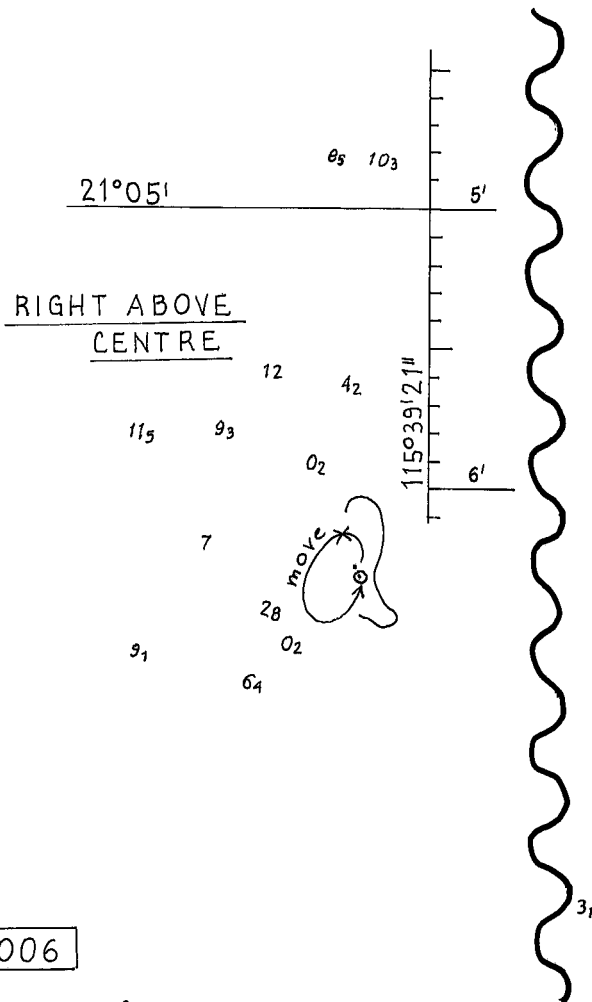

856/2006

1030/2006

© Commonwealth of Australia 2006

AUS

F3  
63



520/2006

1037/2006

© Commonwealth of Australia 2006

F6  
AUS 169

PLAN:  
SCHOUTEN PASSAGE

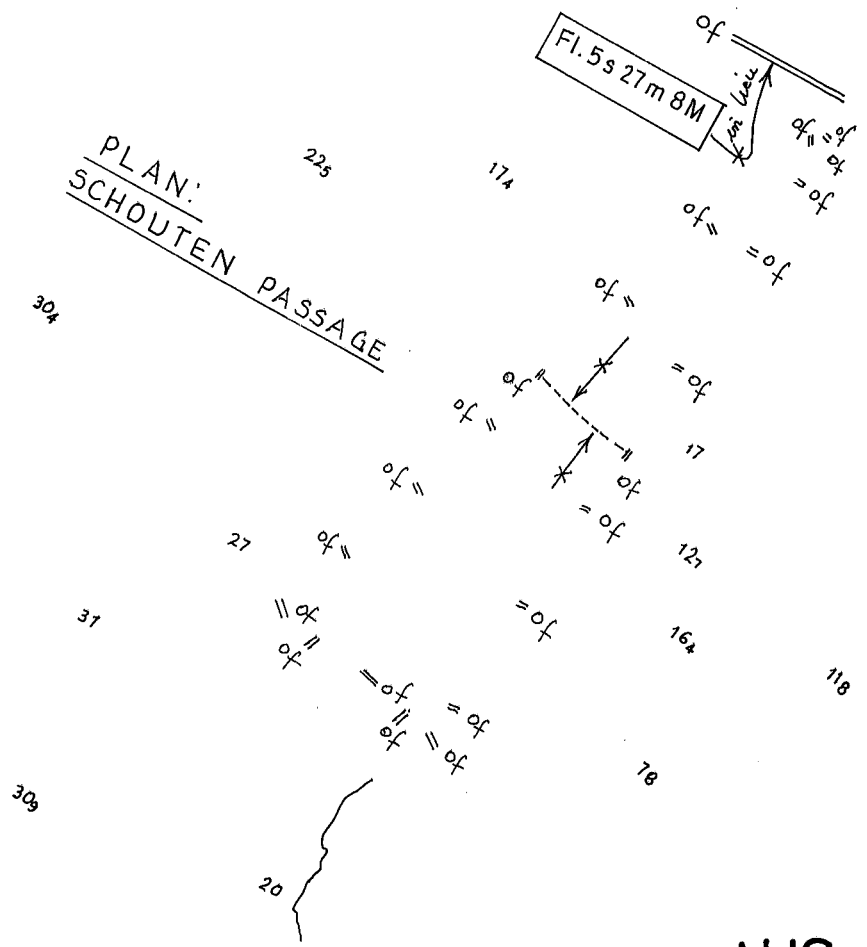
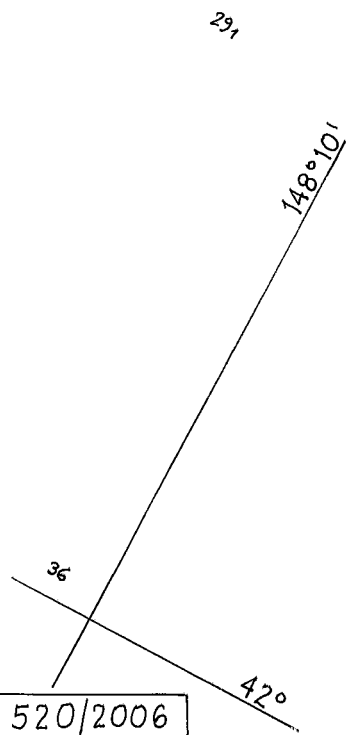

PLAN:  
LITTLE OYSTER COVE

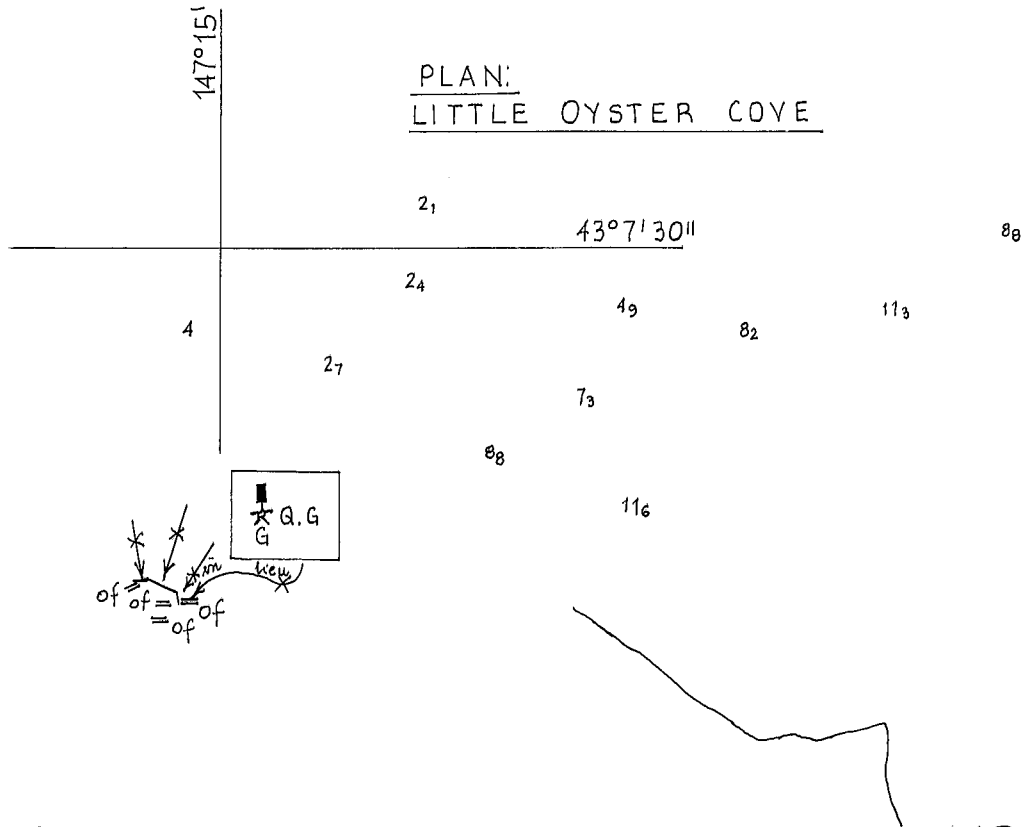

869/2006

1035/2006

© Commonwealth of Australia 2006

F6  
AUS 173

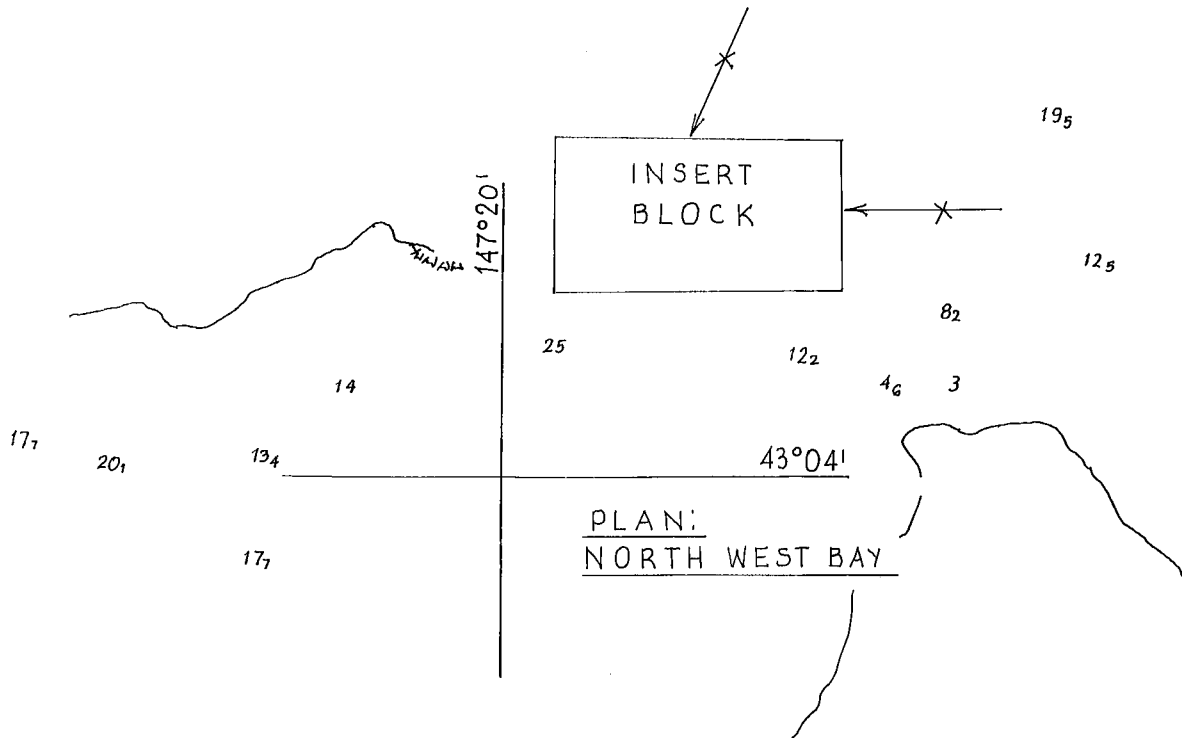

869/2006

1036/2006

© Commonwealth of Australia 2006

F6  
AUS 174

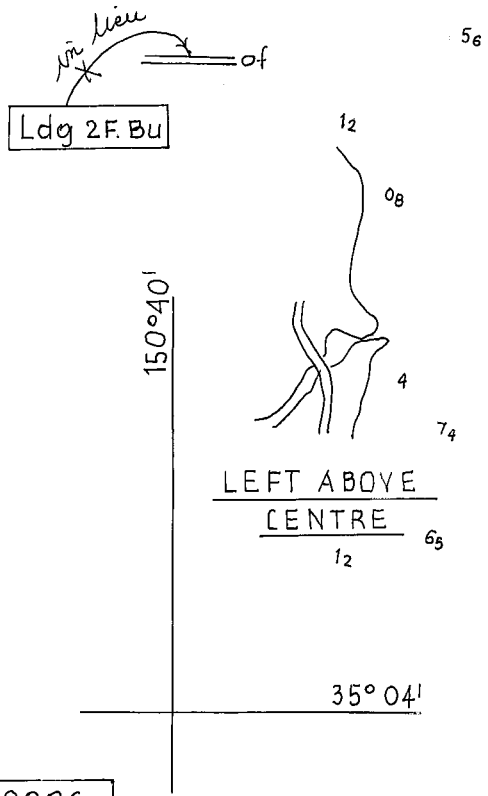

900/2006

1018/2006

© Commonwealth of Australia 2006

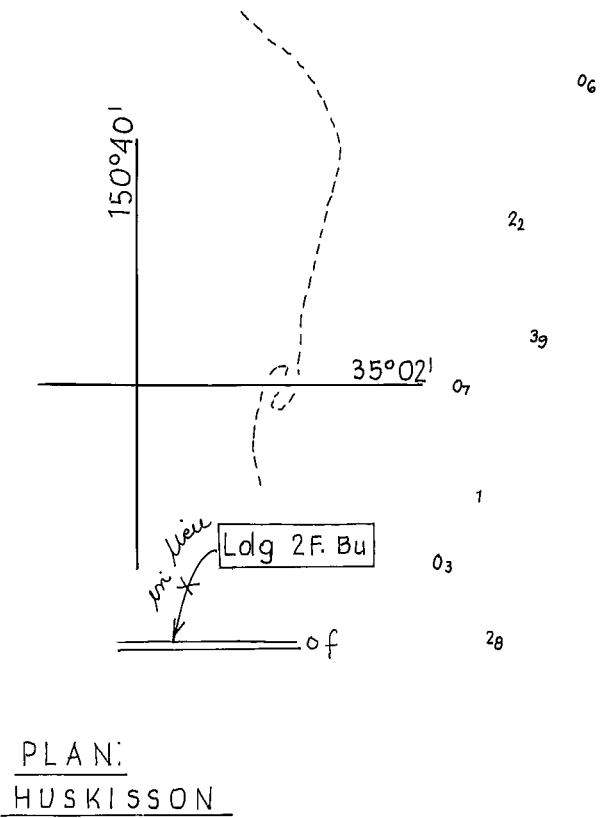

F7

AUS 193

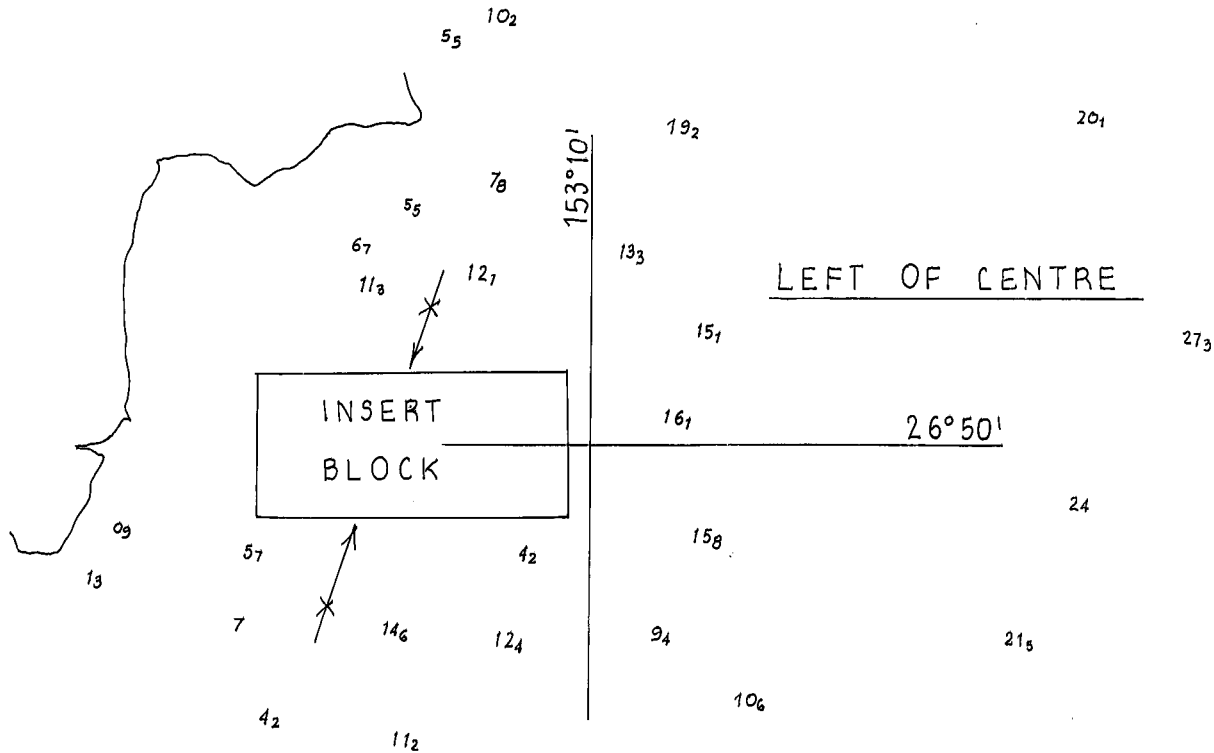

789/2006

1019/2006

© Commonwealth of Australia 2006

F7

AUS 235

RIGHT BELOW CENTRE

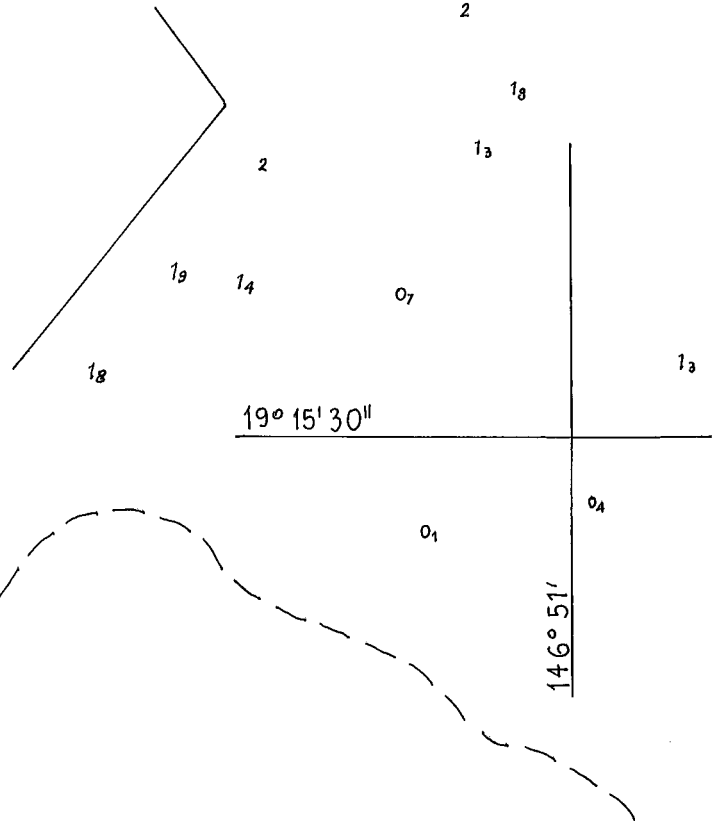
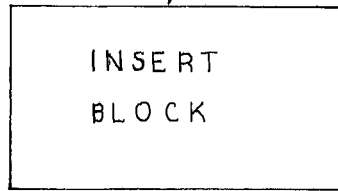

791/2006

1022/2006

© Commonwealth of Australia 2006

F8

AUS 257

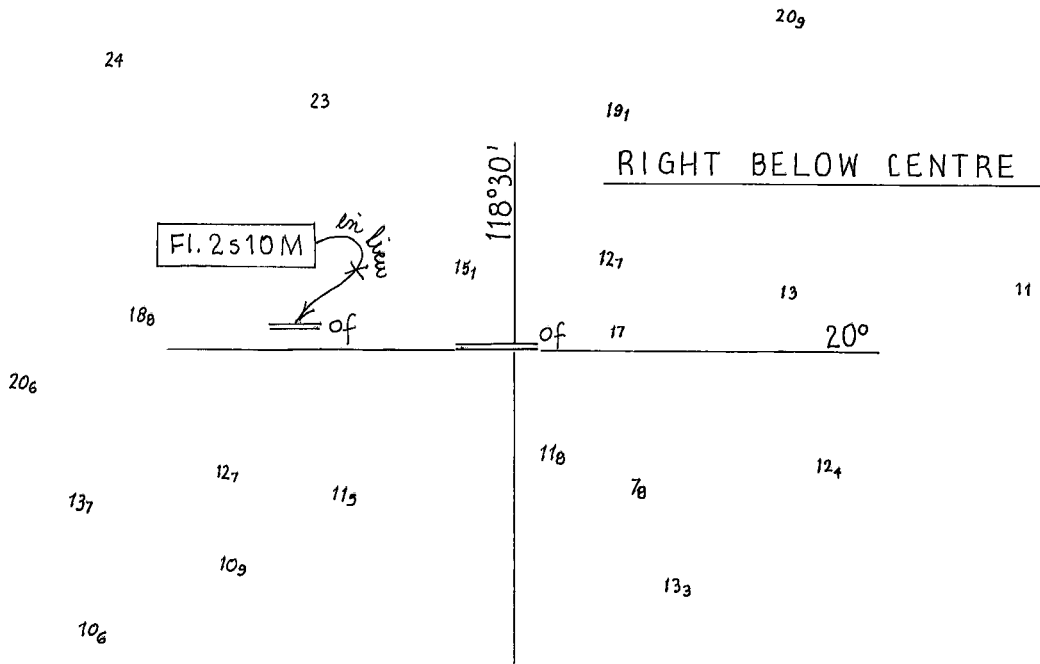

569/2006

1029/2006

© Commonwealth of Australia 2006

F3  
AUS 326

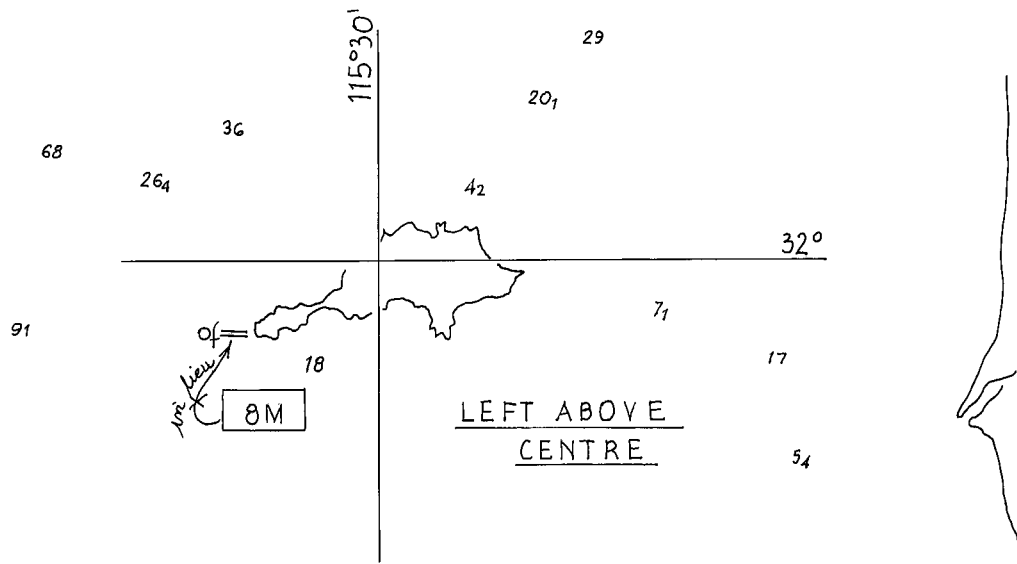

978/2006

1032/2006

© Commonwealth of Australia 2006

F4  
AUS 334

INSERT  
BLOCK



10

11

64

37

11

11

65



12

RIGHT ABOVE CENTRE

42

12

92

41

16

104

7

138° 30'

35°

11

10

925/2006

1034/2006

© Commonwealth of Australia 2006

F5  
AUS 345



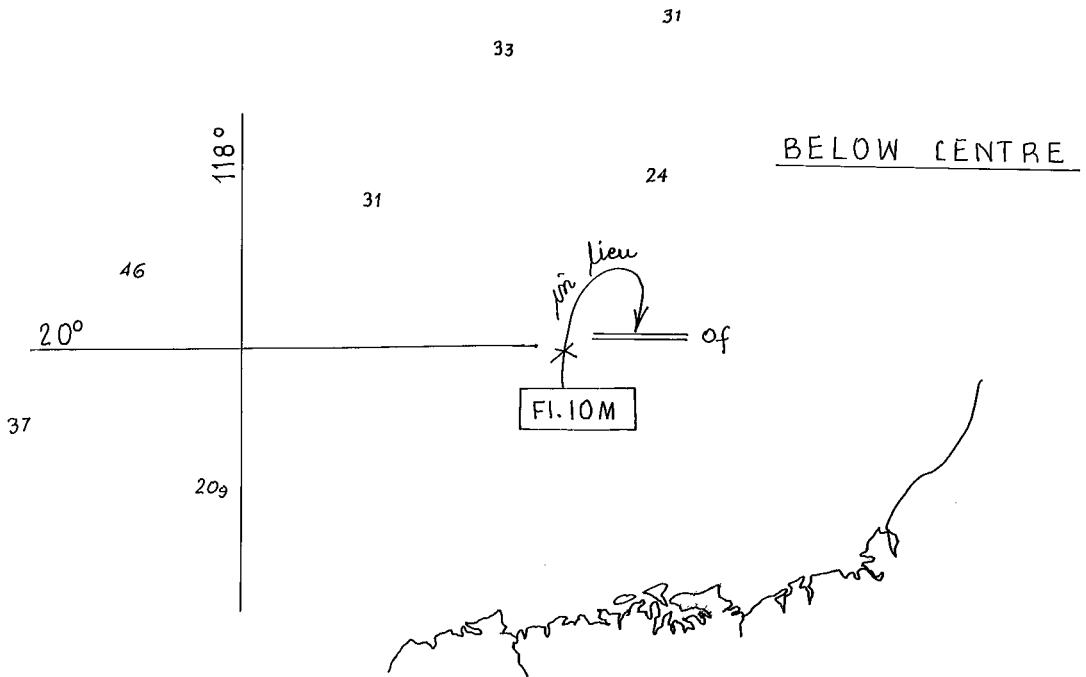

705/2006

1029/2006

© Commonwealth of Australia 2006

F1

AUS 415

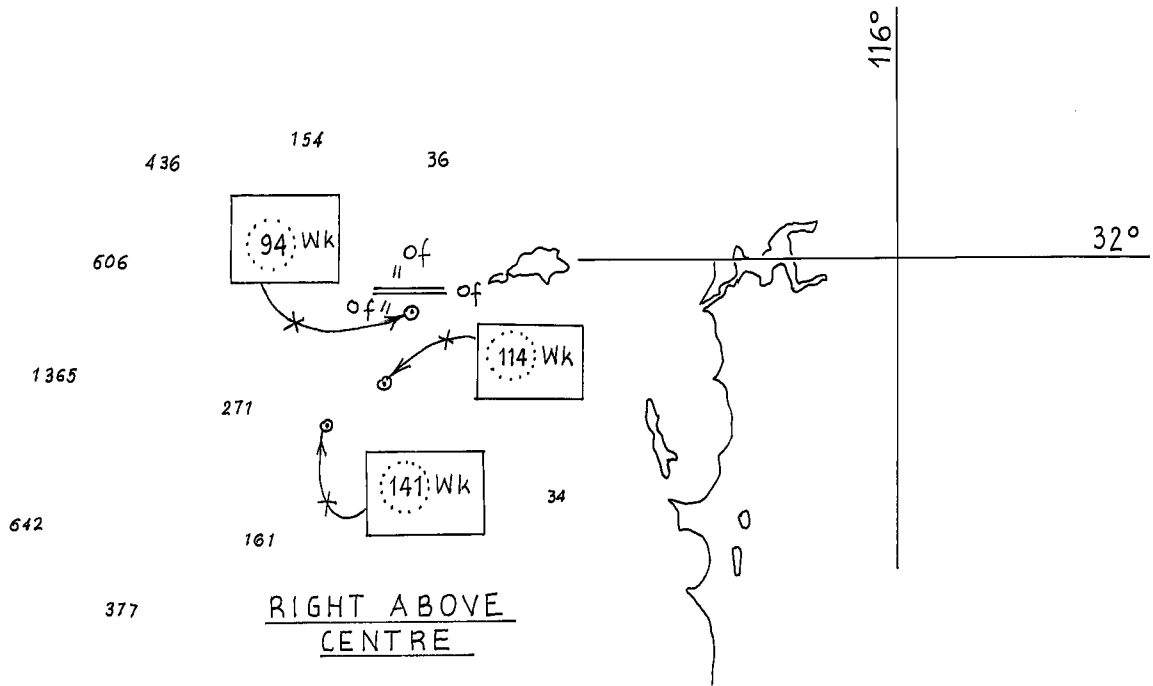

516/2006

1033/2006

© Commonwealth of Australia 2006

F1  
AUS 417

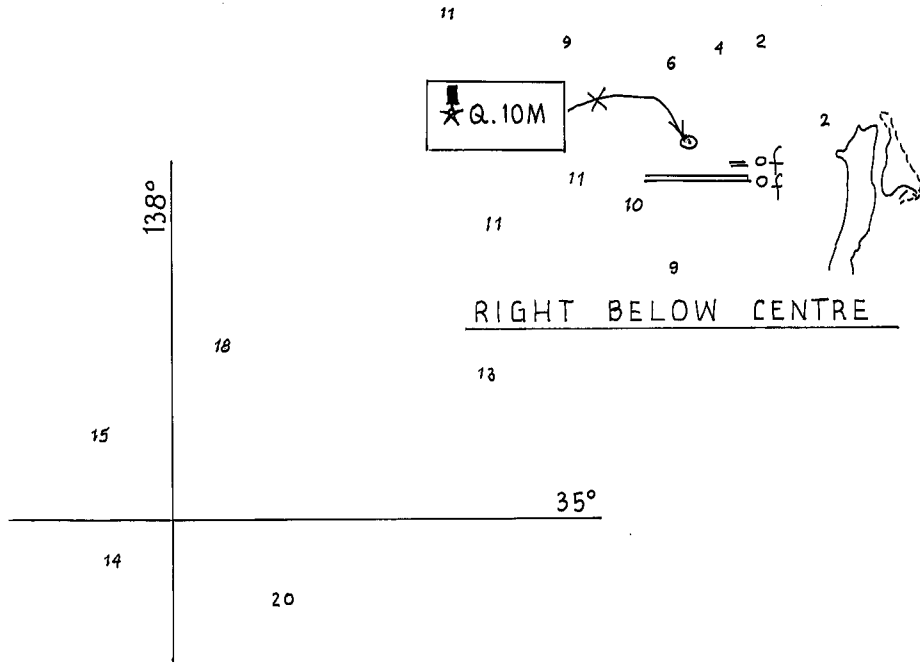

925/2006

1034/2006

© Commonwealth of Australia 2006

F1

AUS 444



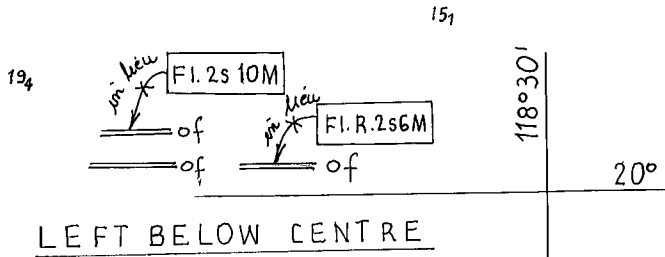

16

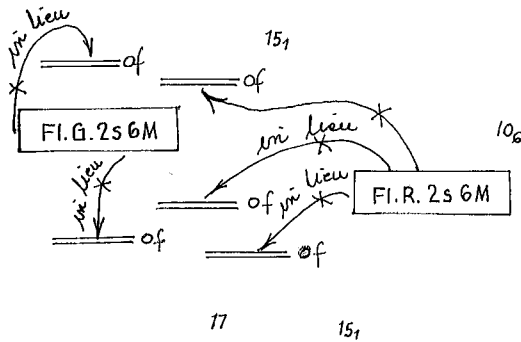

17

151

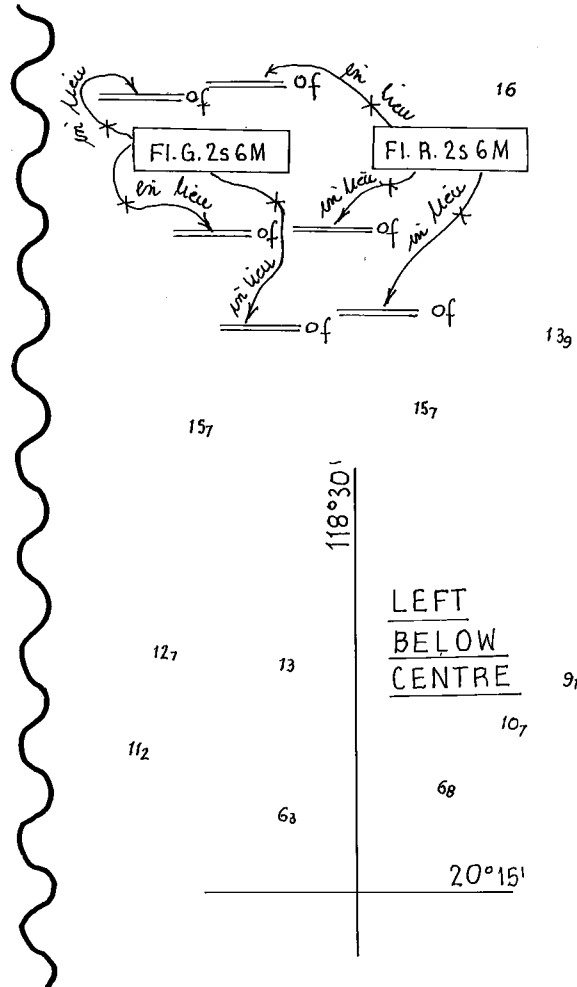

157

157

127

73

LEFT  
BELOW  
CENTRE

127

91

107

63

68

619/2006

1029/2006

© Commonwealth of Australia 2006

F3  
AUS 739

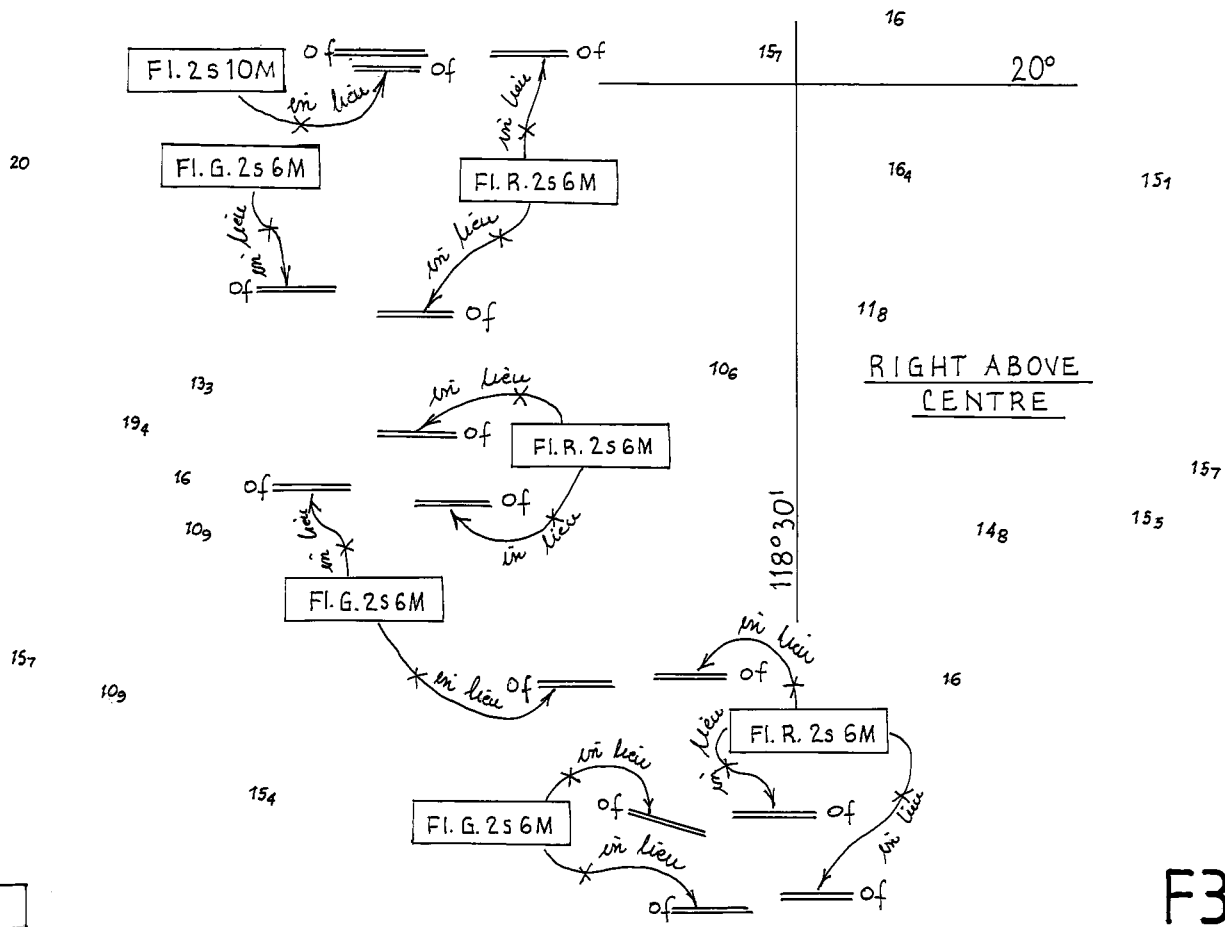

634/2006

1029/2006

© Commonwealth of Australia 2006

F3  
AUS 740

71

67

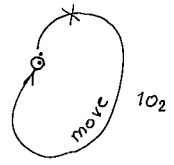

102

72

106

114

67



115°45'



74

95



99

RIGHT ABOVE  
CENTRE

104

67

96

71

56

59

53

21° 15'

41

22

924/2006

1030/2006

© Commonwealth of Australia 2006

F3  
AUS 743

==== of  
===== of  
===== of  
===== of  
===== of  
===== of  
===== of

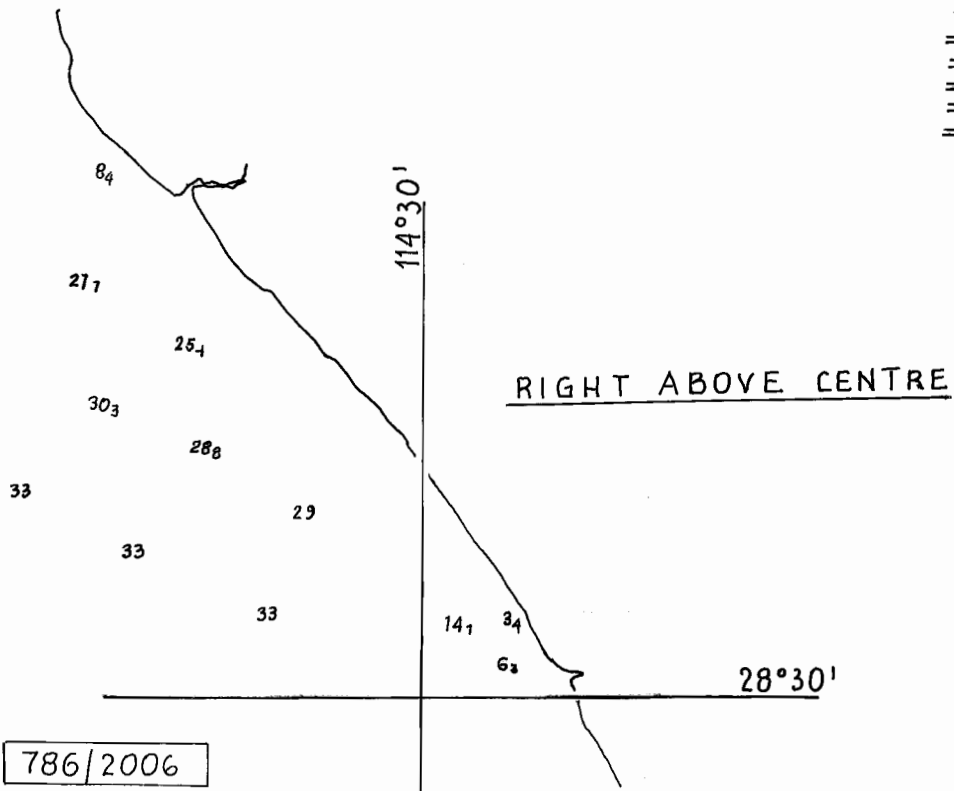

786/2006

1017/2006

© Commonwealth of Australia 2006

F4  
AUS 751



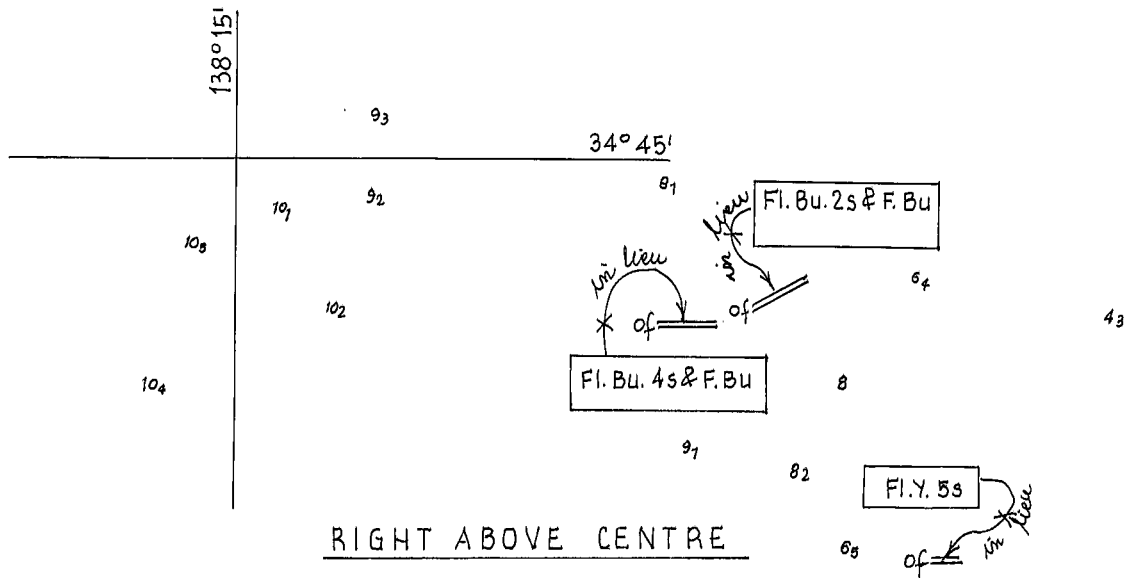

981/2006

1034/2006

© Commonwealth of Australia 2006

F5  
AUS 780

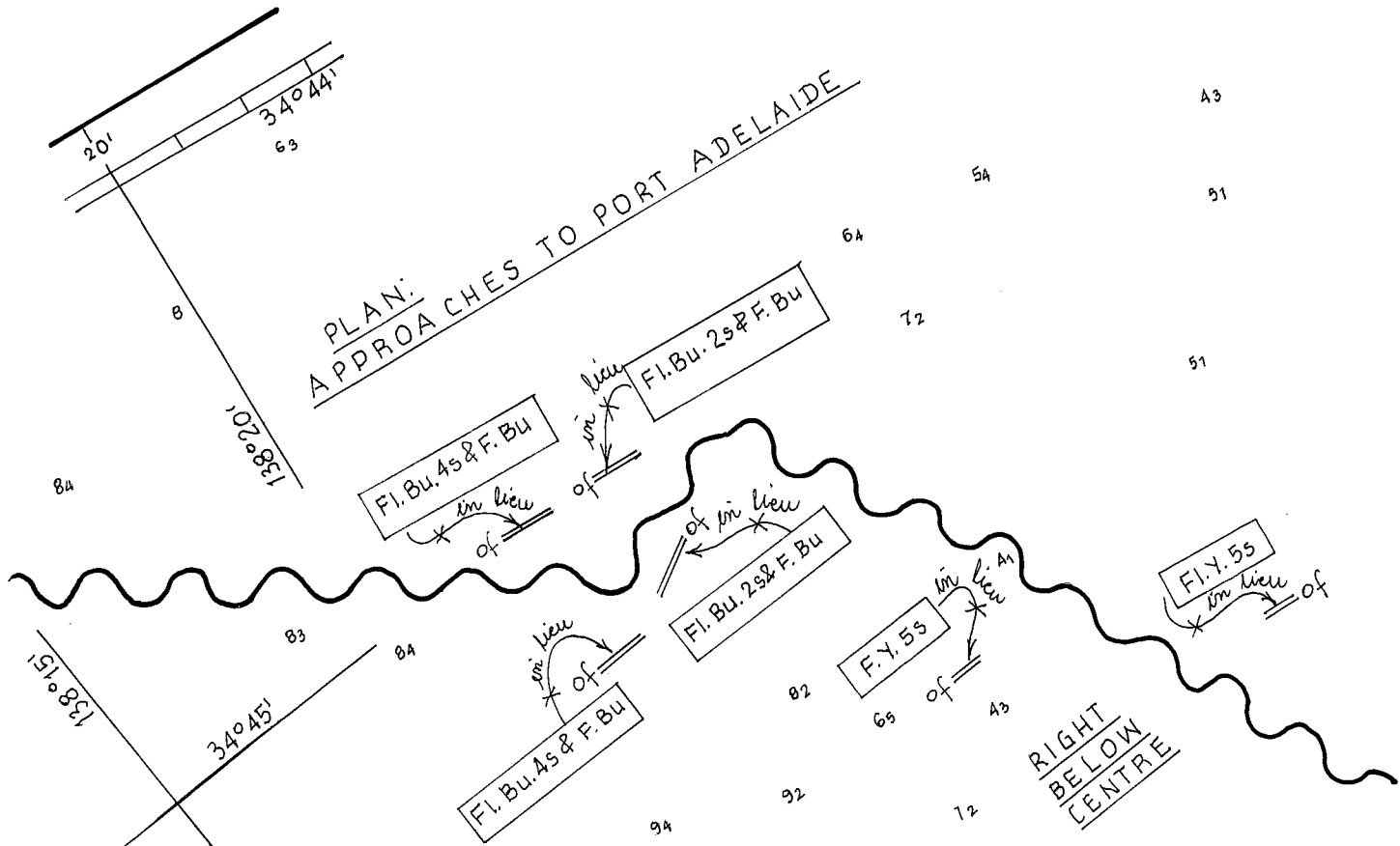

981/2006

1034/2006

© Commonwealth of Australia 2006

F5  
AUS 781

58

52

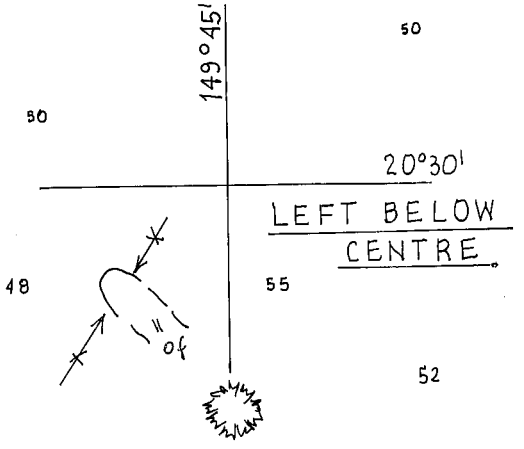
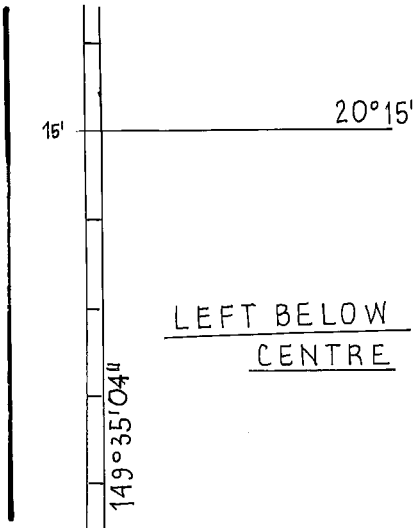

SUBSTITUTE  
(R T)  
NOTE

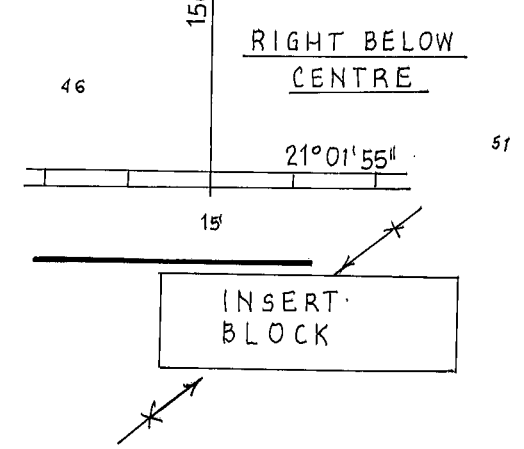
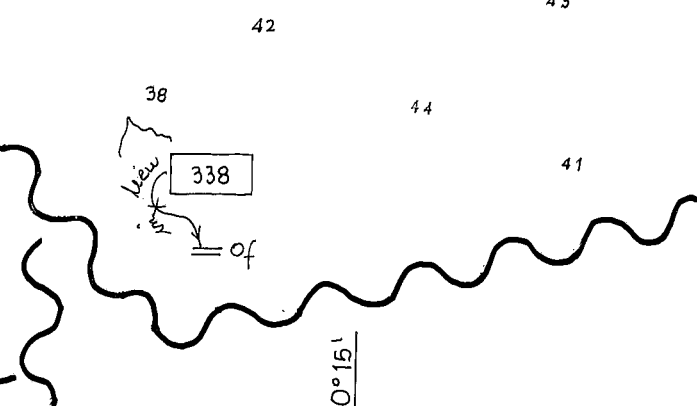
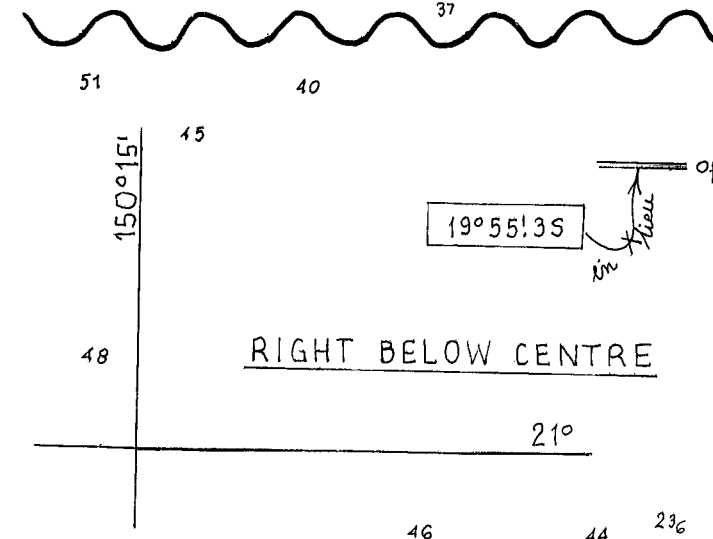
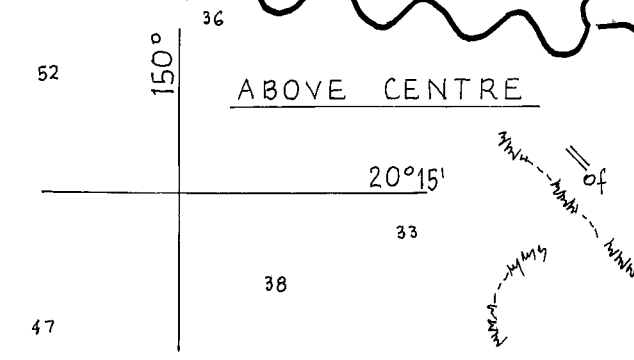
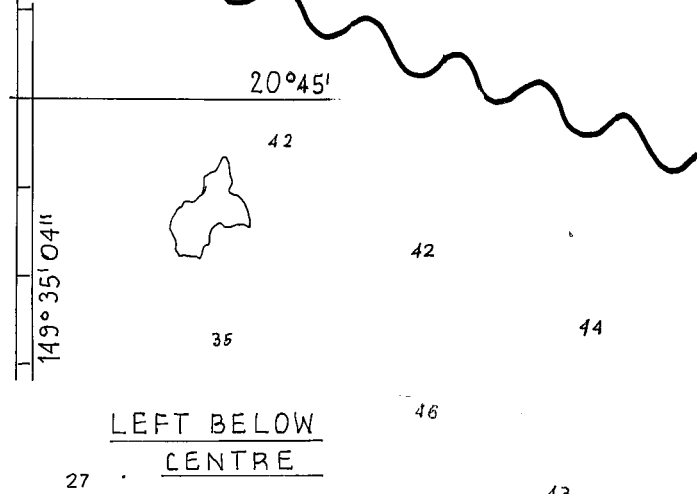

965/2006

48 51 51

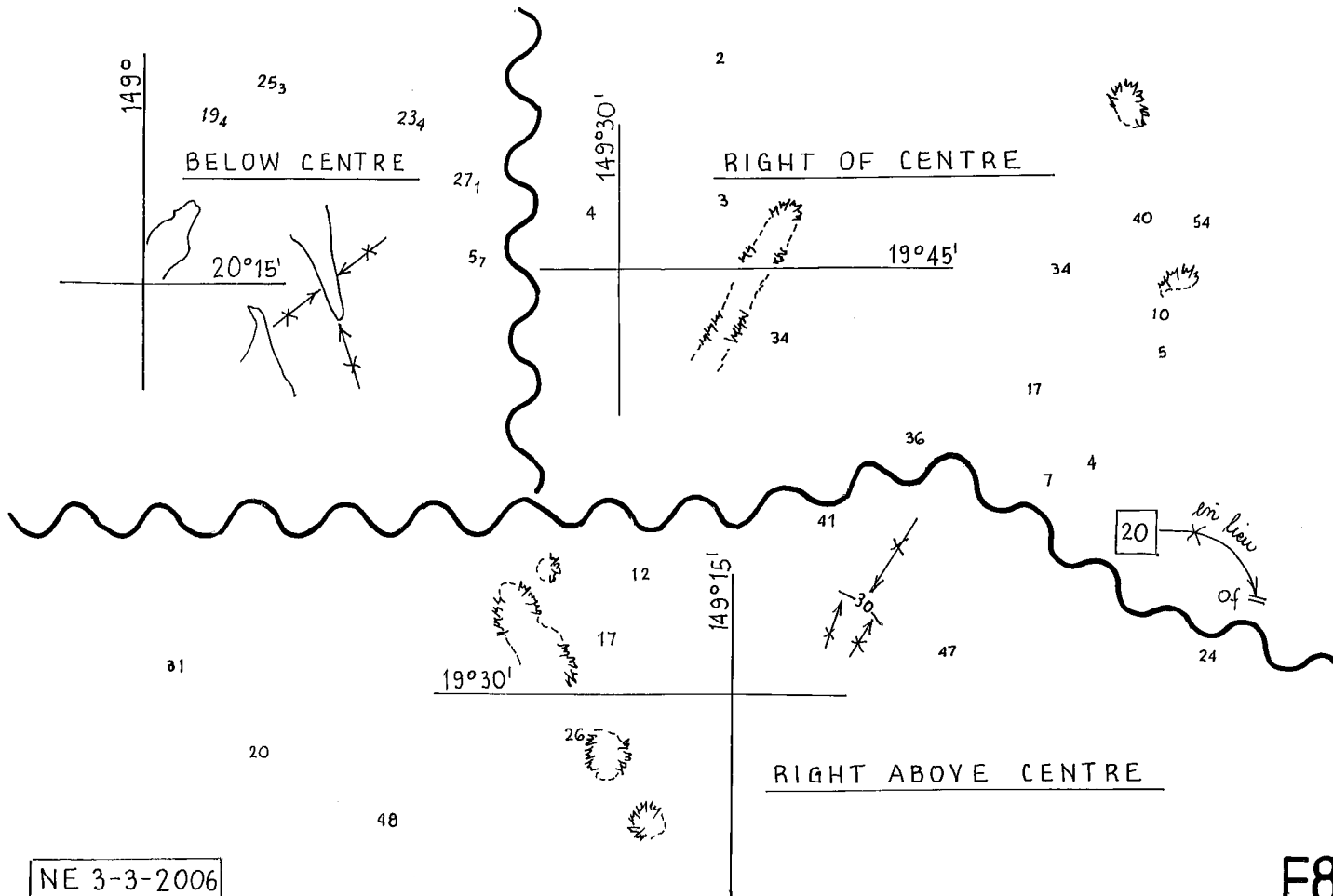

NE 3-3-2006

1021/2006

© Commonwealth of Australia 2006

F8

AUS 825

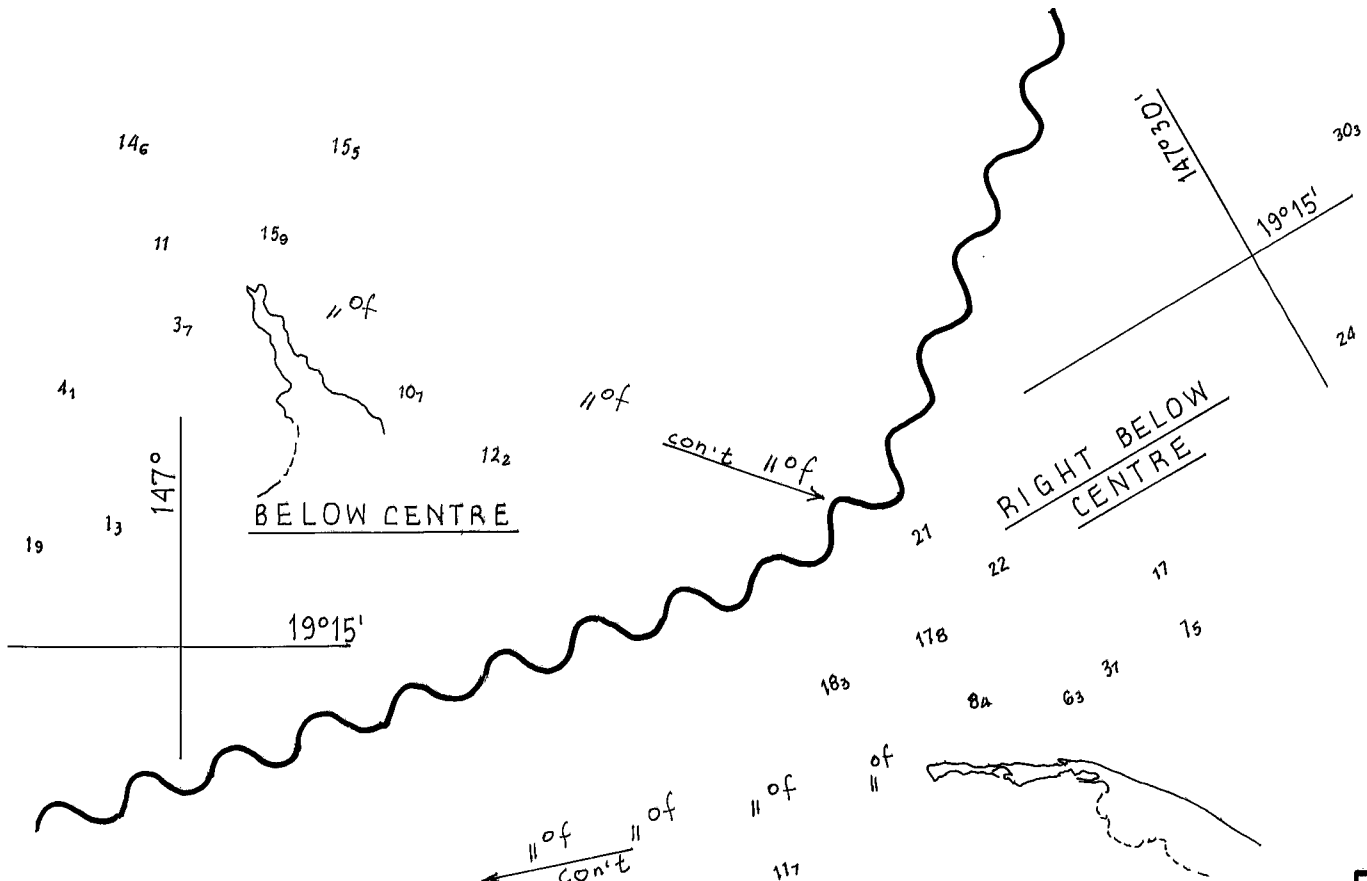

792/2006

1017/2006

© Commonwealth of Australia 2006

F8  
AUS 827

LEFT ABOVE CENTRE

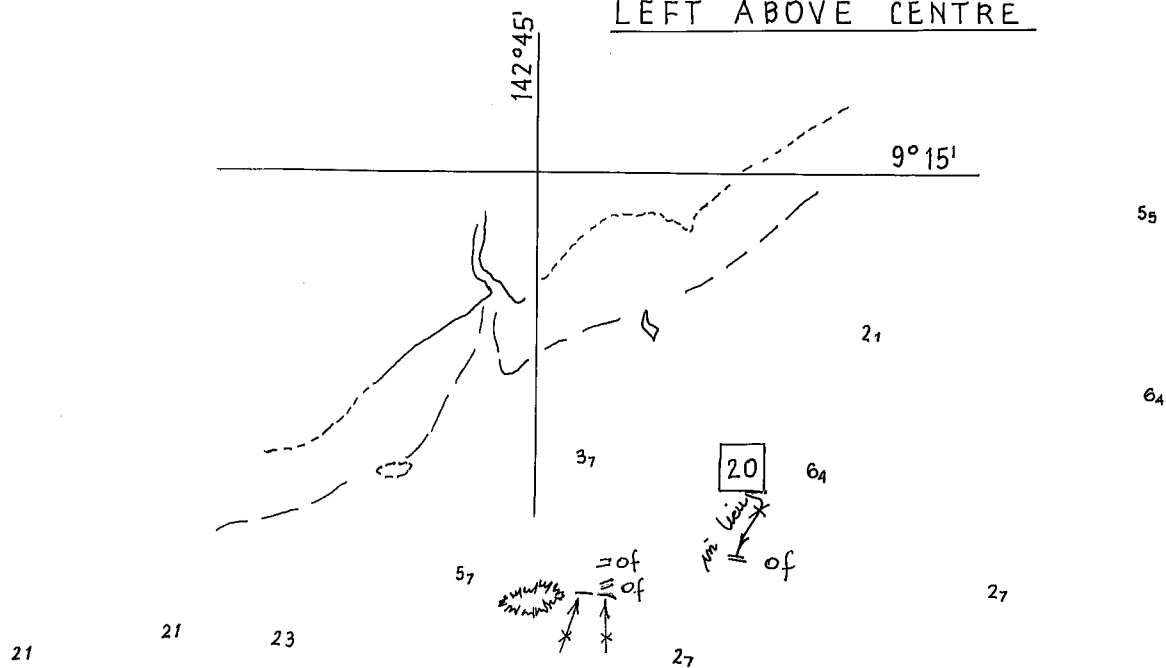

845/2006

1023/2006

© Commonwealth of Australia 2006

F8  
AUS 840

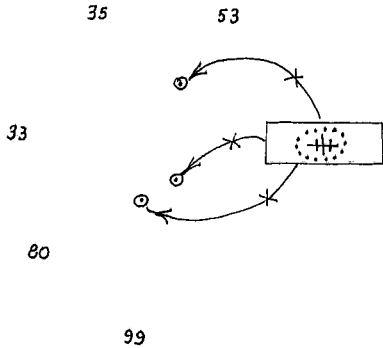

1847 2013

5°

69

LEFT ABOVE CENTRE.

315

331

120°

733

1220

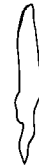

974 | 2006

1026/2006

© Commonwealth of Australia 2006

F1

INT 603

AUS 4603

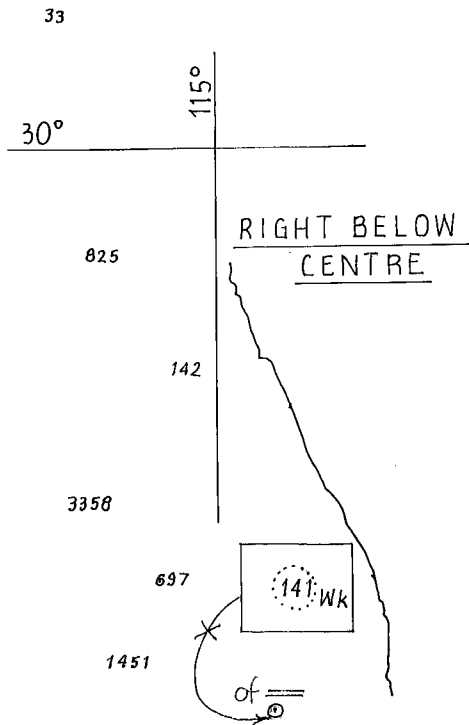

973/2006

1026 to 1028, 1033/2006 © Commonwealth of Australia 2006

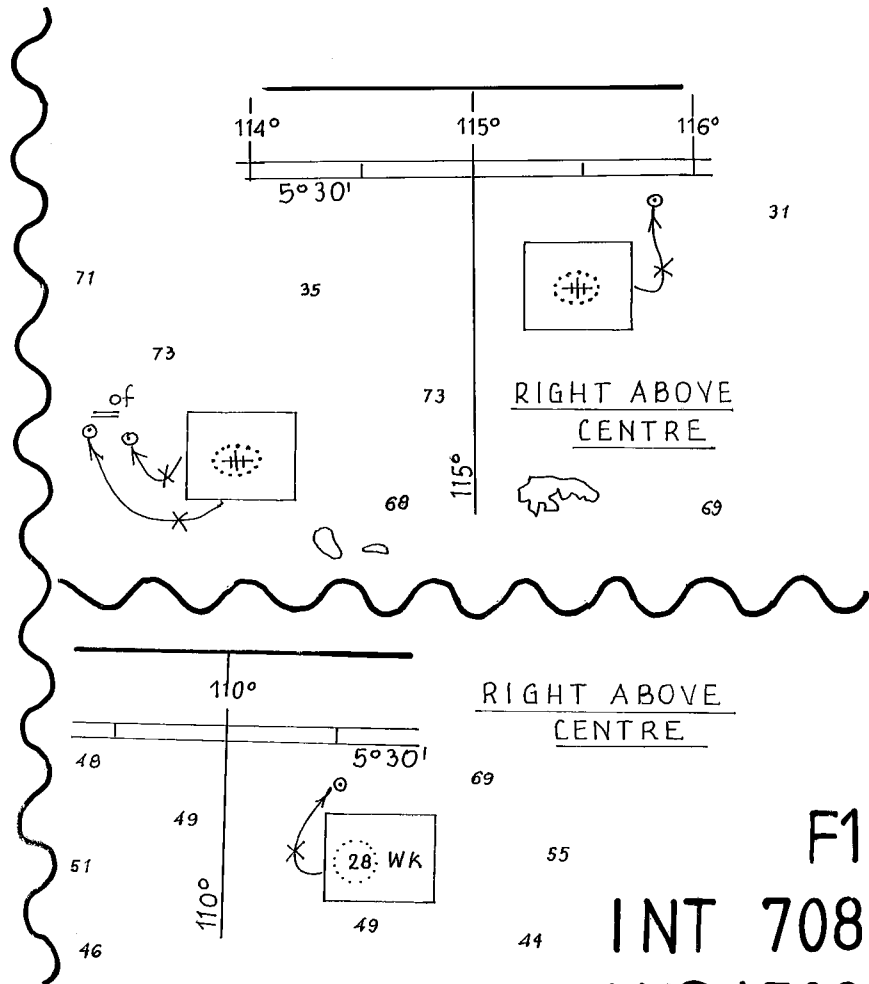

F1  
INT 708  
AUS 4708

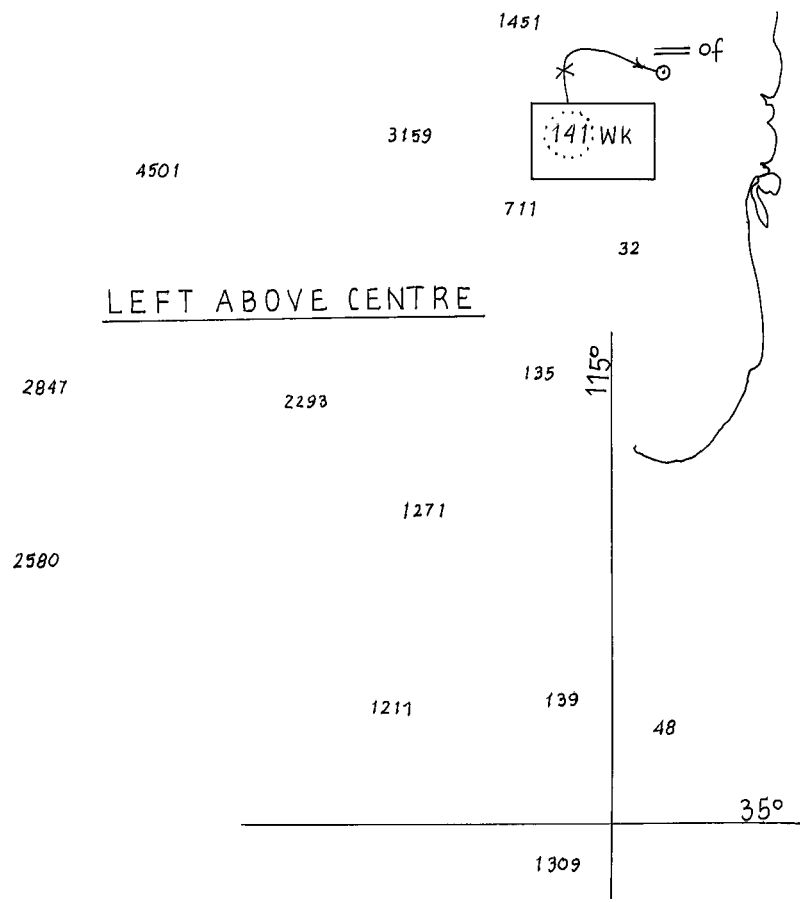

356/2006

1033/2006

© Commonwealth of Australia 2006

F1  
INT 709  
AUS4709

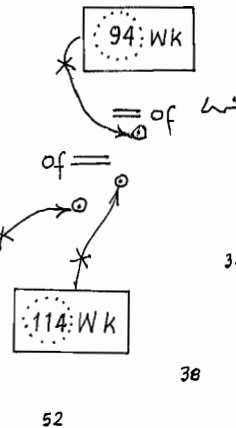
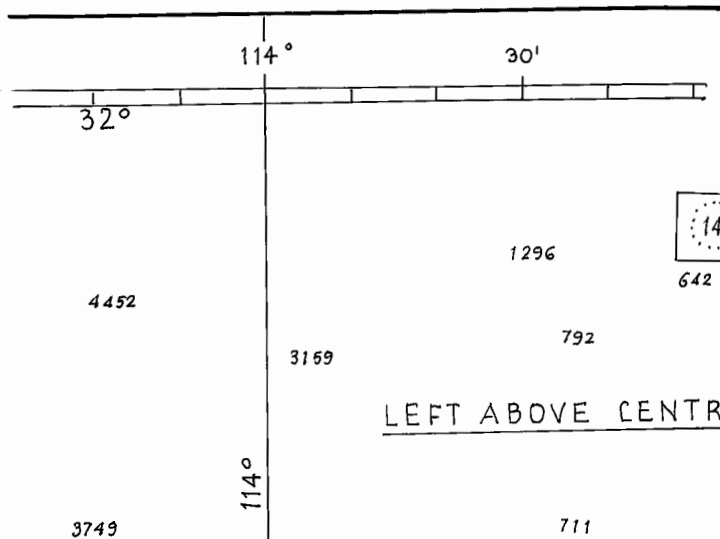

49/2006

1033/2006

© Commonwealth of Australia 2006

F1  
INT 726  
AUS 4726