

145°

135

LEFT ABOVE CENTRE

219

1° 30'

46

23

F10

467 / 1995

268 / 2002

© Commonwealth of Australia 2002

Aus 663

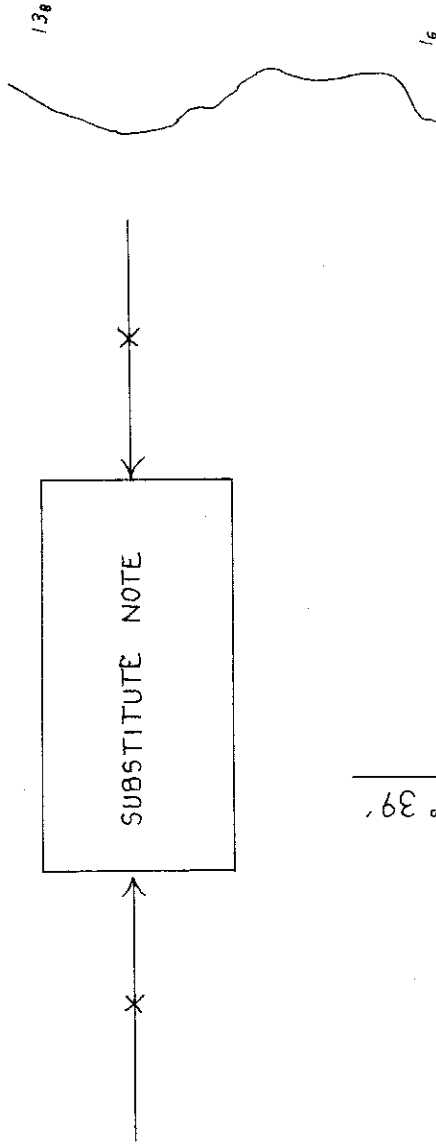

13e

1e

149° 39'

LEFT BELOW CENTRE

5° 33'

F10

226 / 1983

268 / 2002

© Commonwealth of Australia 2002

Aus 665

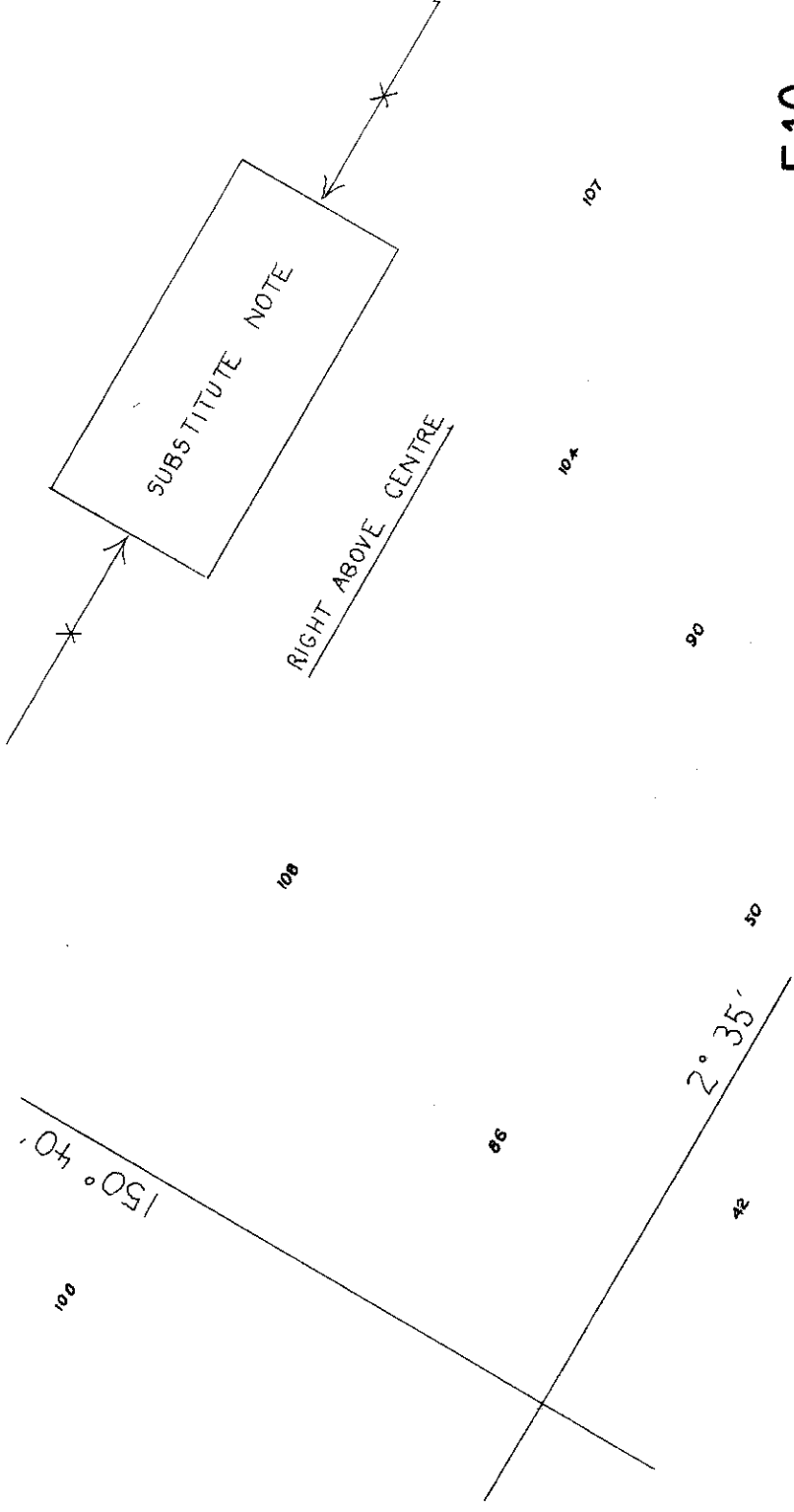

467 / 1995

268 / 2002

© Commonwealth of Australia 2002

F10  
Aus666

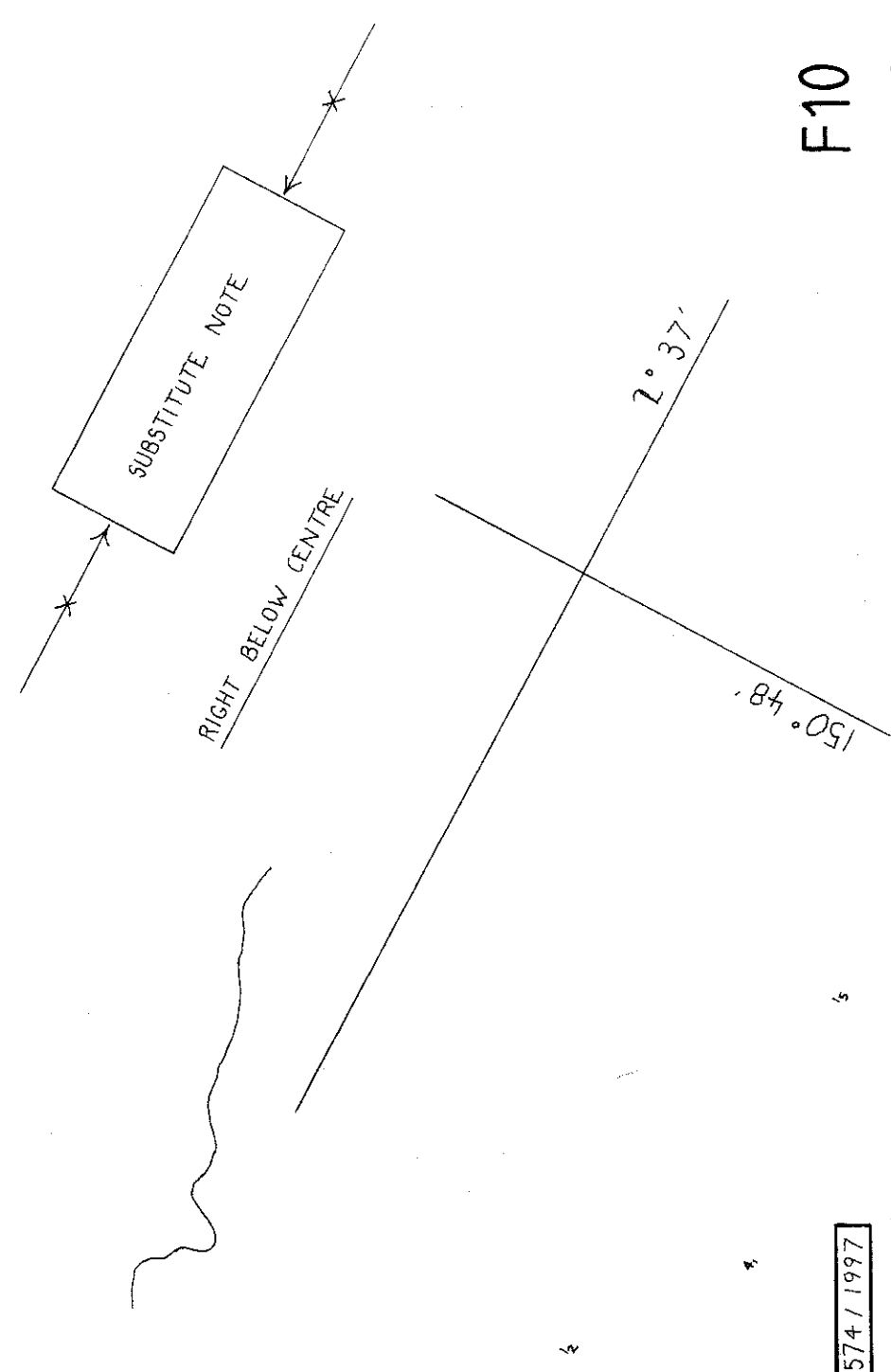

574 / 1997

268 / 2002

© Commonwealth of Australia 2002

F10  
Aus667

128

152° 29' 06"

3° 38'

97

RIGHT BELOW CENTRE

12

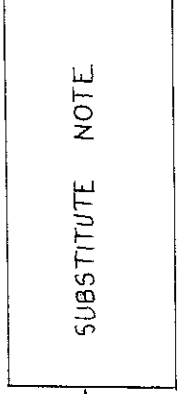

38'

F10

45/2000

268/2002

© Commonwealth of Australia 2002

Aus 668

73

3

33

06

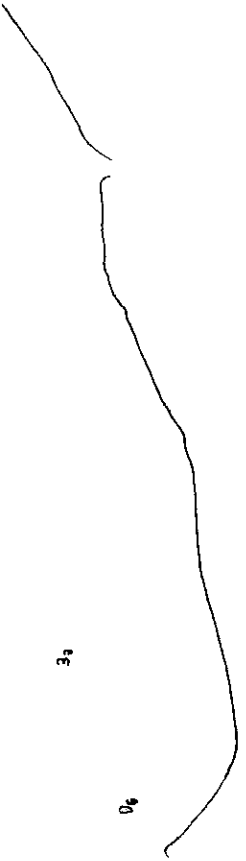

150° 12'

RIGHT BELOW CENTRE

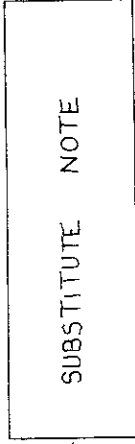

5° 34'

F10

289/2000

268/2002

© Commonwealth of Australia 2002

Aus 674

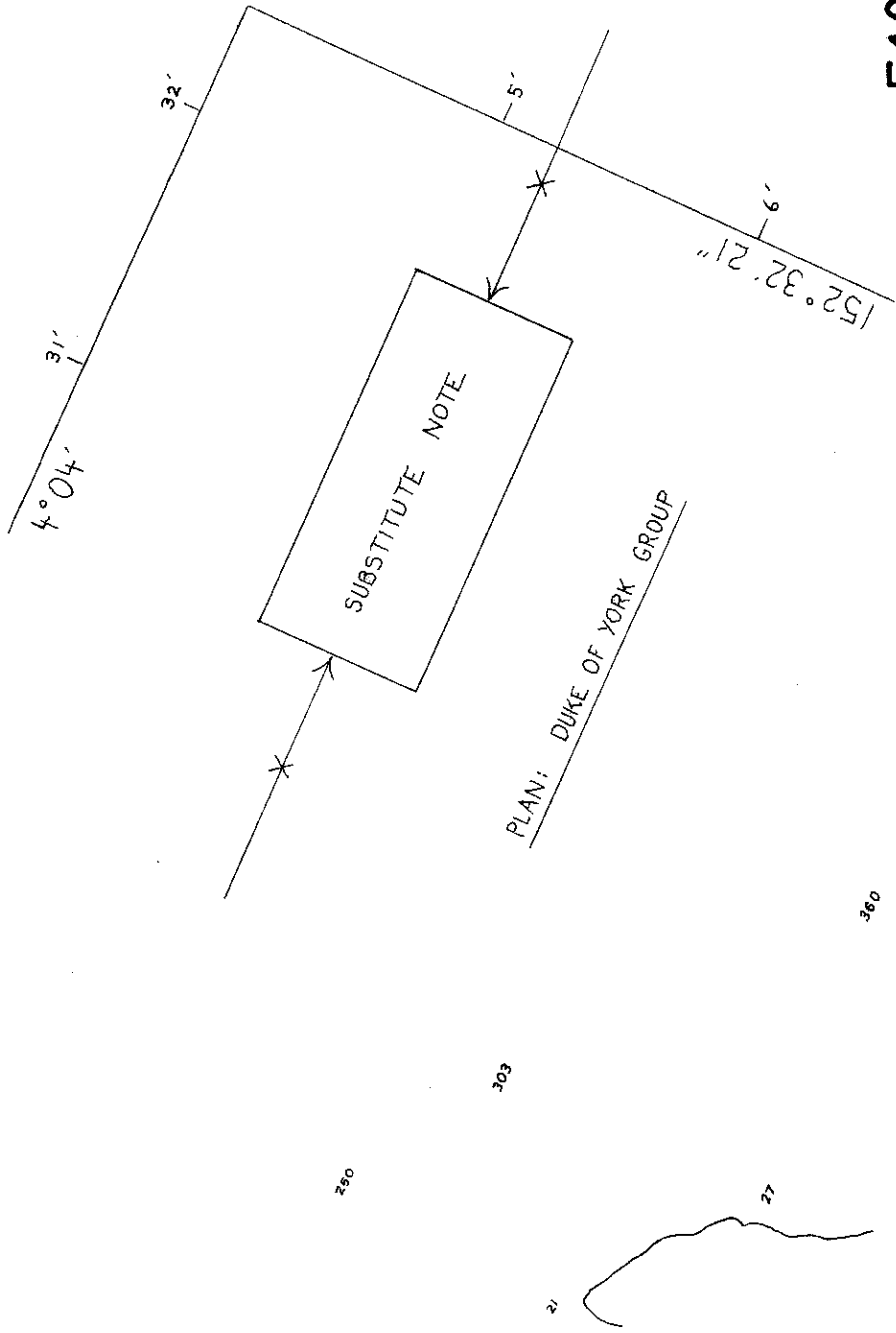

45 / 2000

F10

268/2002

© Commonwealth of Australia 2002

AUS 679

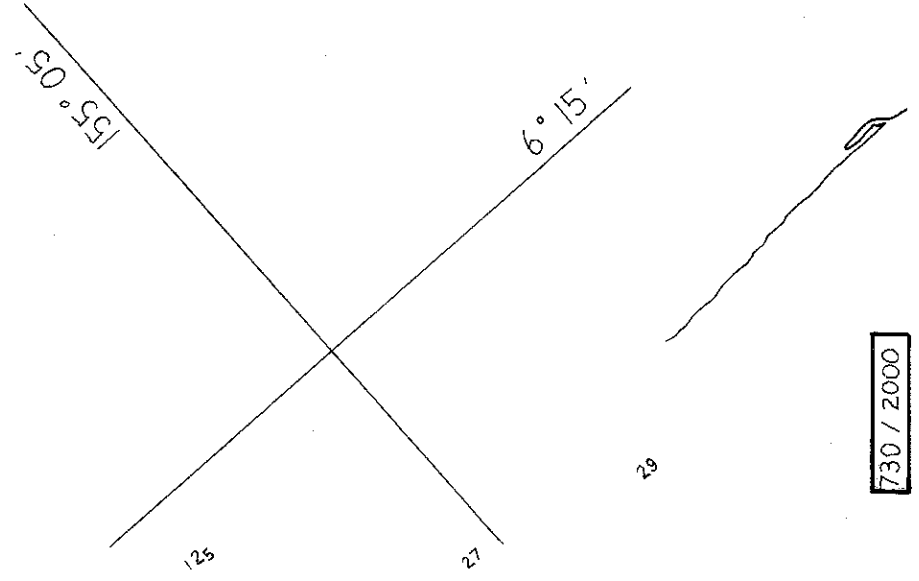

730 / 2000

F10

268/2002

© Commonwealth of Australia 2002

AUS 684

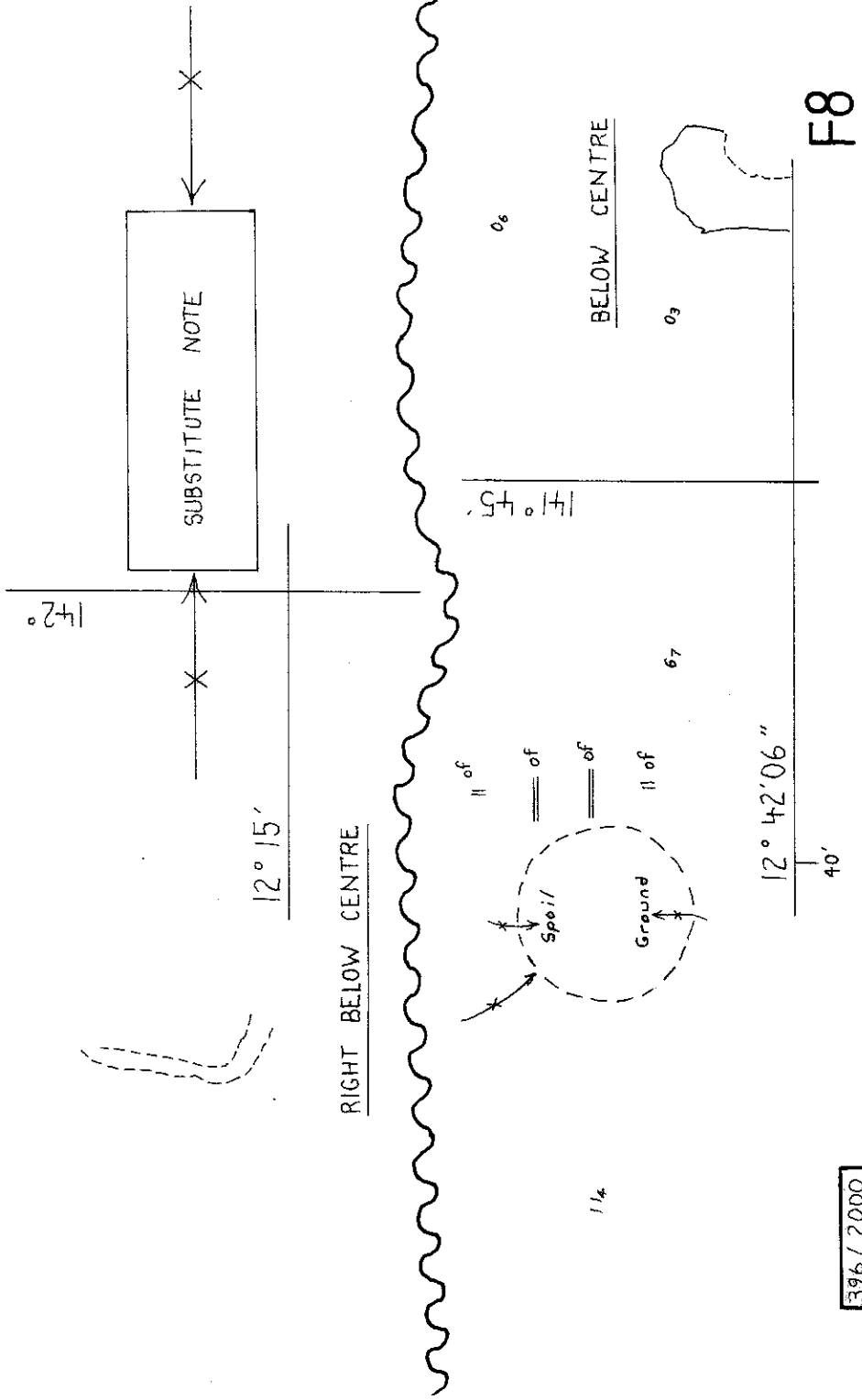

396 / 2000

268, 272 / 2002

© Commonwealth of Australia 2002

AUS 701

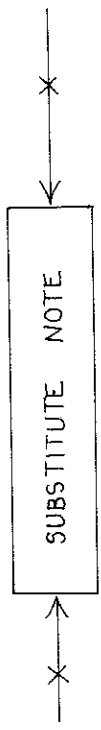
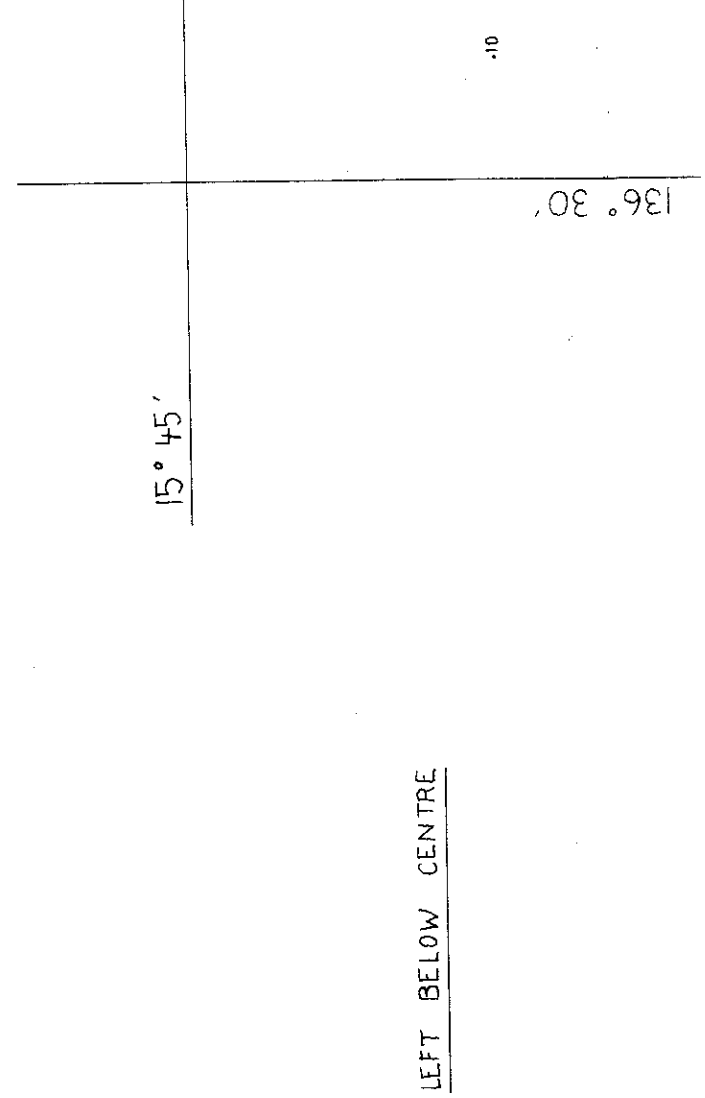

F2

650 / 2000

268 / 2002

© Commonwealth of Australia 2002

AUS 710

129° 30'

32

14

RIGHT ABOVE CENTRE

34

14° 15'

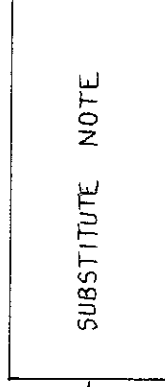

SUBSTITUTE NOTE

69

70

NC 30/4/1989

62

F2

268/2002

© Commonwealth of Australia 2002

AUS 725

45' 127° 31'

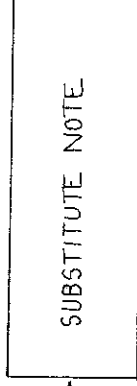

SUBSTITUTE NOTE

45'

50'

LEFT BELOW CENTRE

99/2001

268/2002

© Commonwealth of Australia 2002

14° 55'

35'

40'

F2

AUS 726

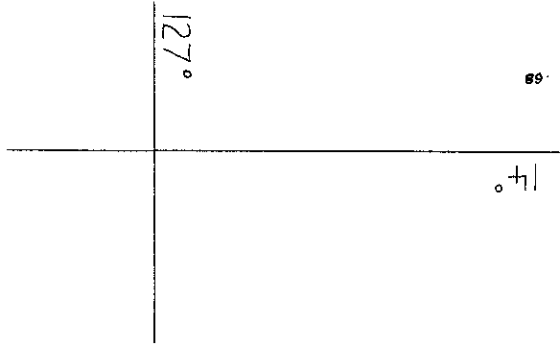

BELOW CENTRE

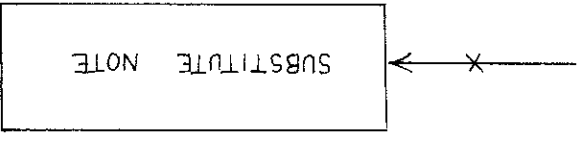

102

222 / 2001

F2

268 / 2002

© Commonwealth of Australia 2002

AUS 727

46

LEFT ABOVE CENTRE

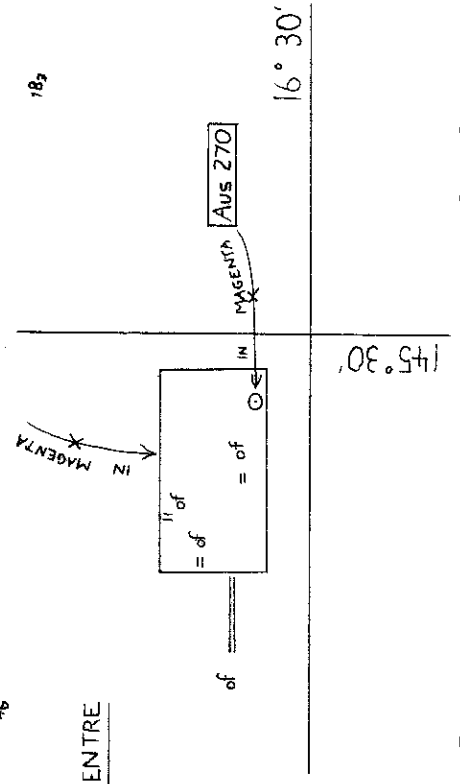

183

22

~~CANCEL SIGLAS~~  
PORT D'IGLAS  
~~PLAN~~

16° 29' 24"

237 / 2002

F8

268 / 2002

© Commonwealth of Australia 2002

AUS 830

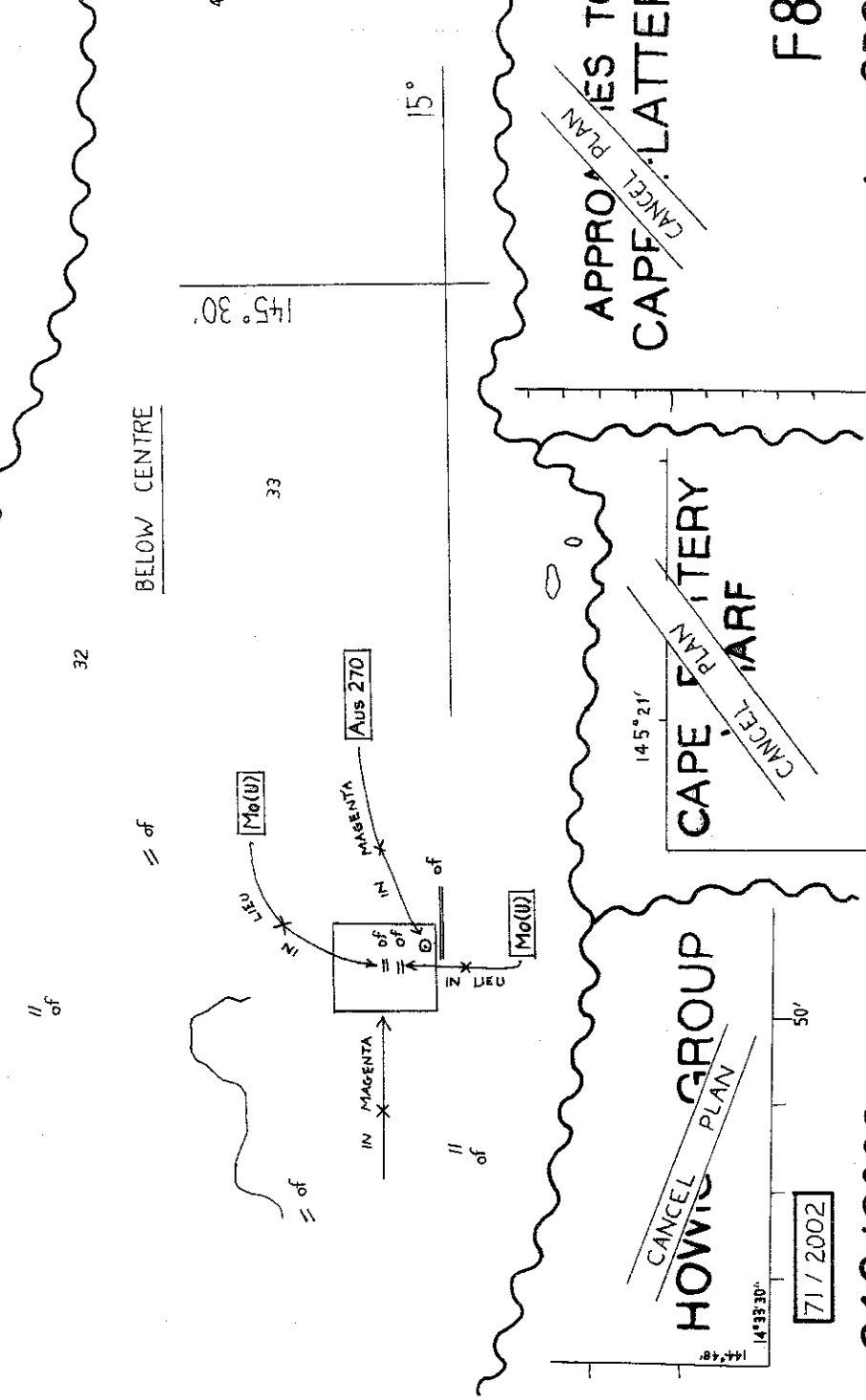
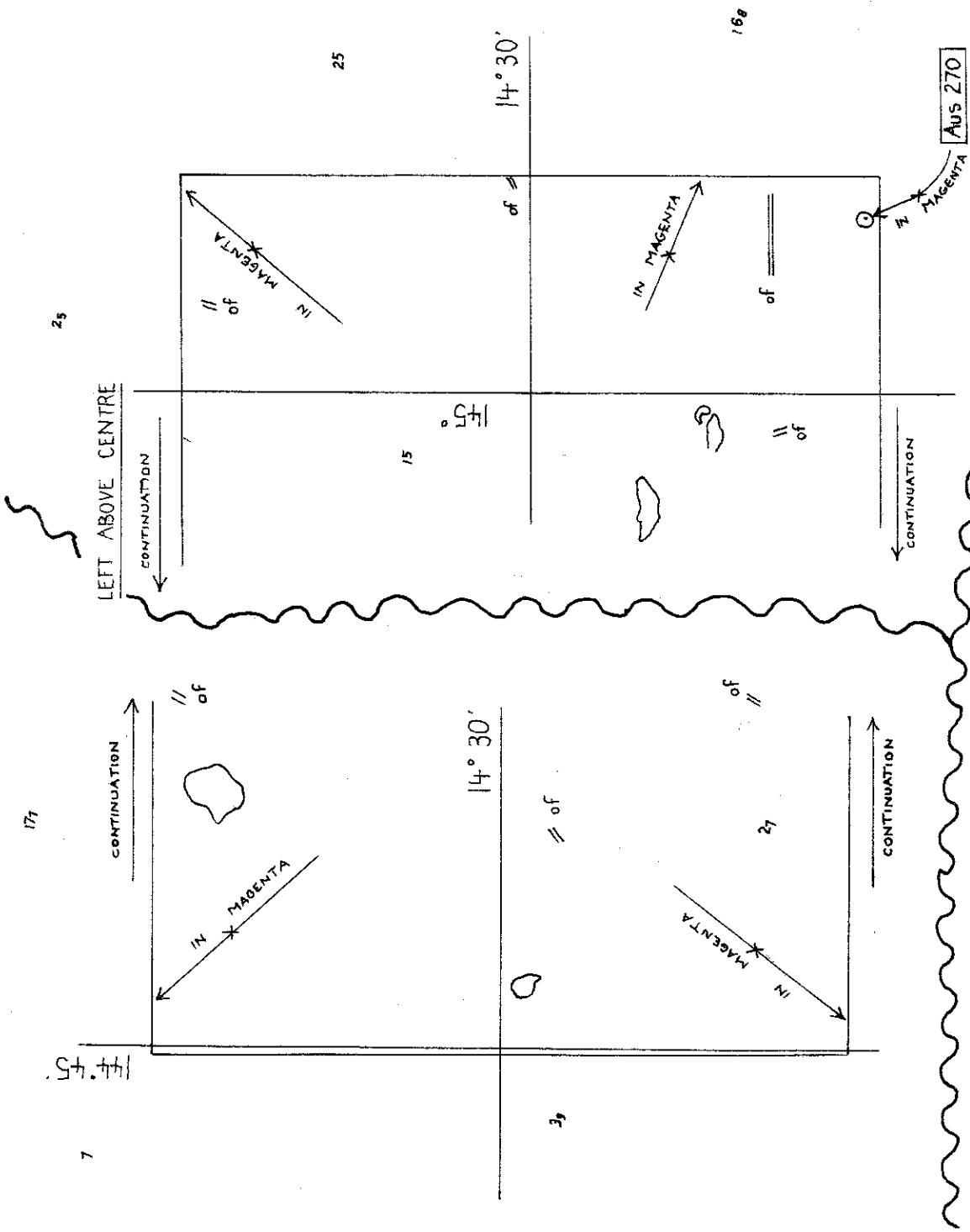

268 / 2002

Commonwealth of Australia 2002

Aus 832

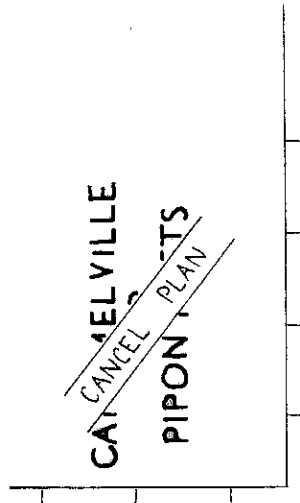
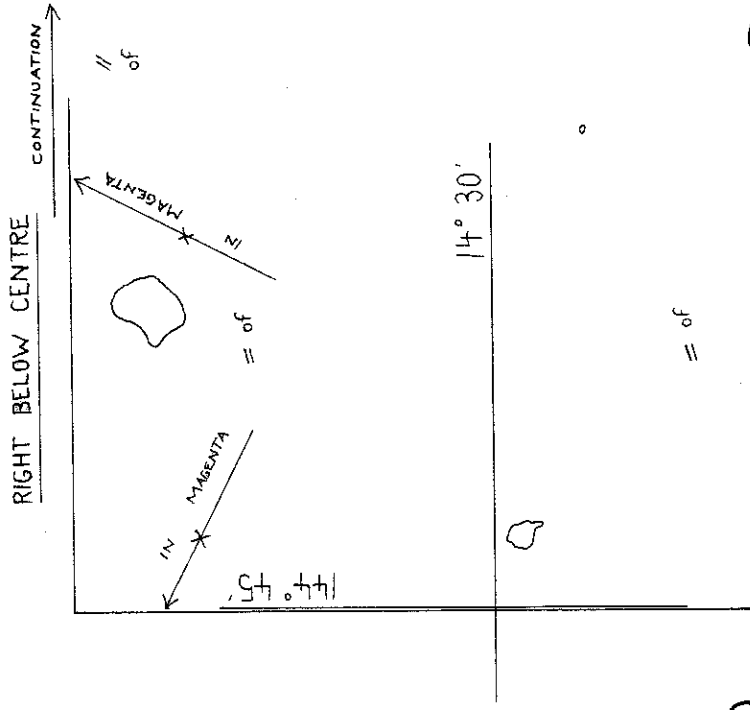

CAMELVILLE  
 CANCELLED  
 PIPON PLAN

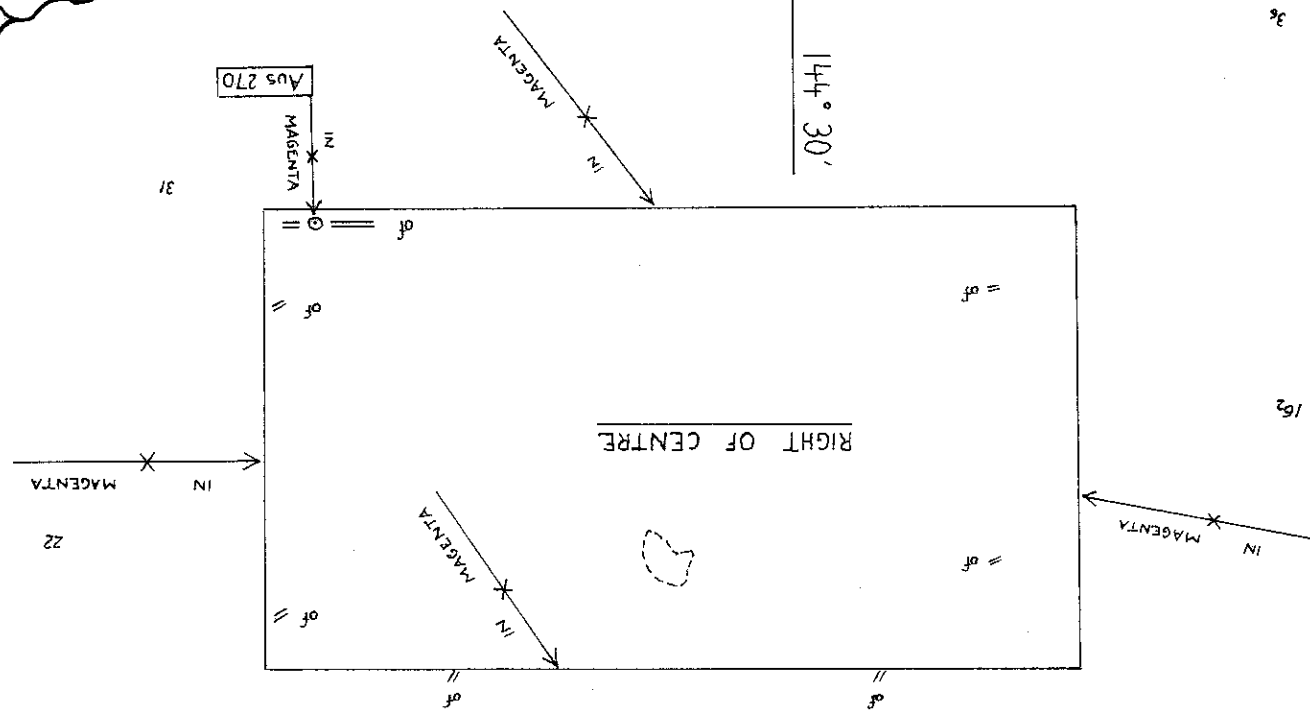

Aus 270

Aus 270

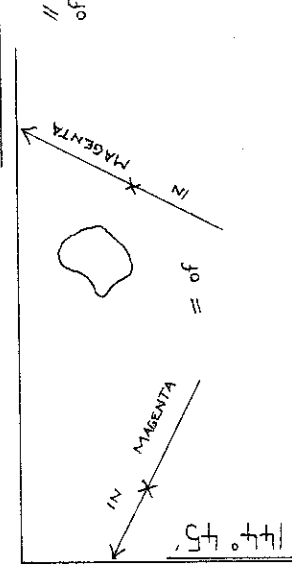

Aus 270

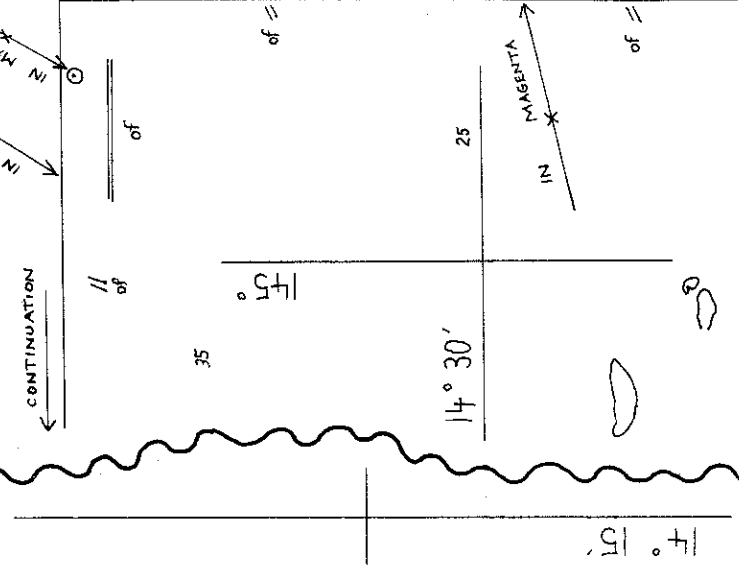

RIGHT BELOW CENTRE

145 / 2002

268 / 2002

© Commonwealth of Australia 2002

AUS 833

F8



LEFT ABOVE CENTRE

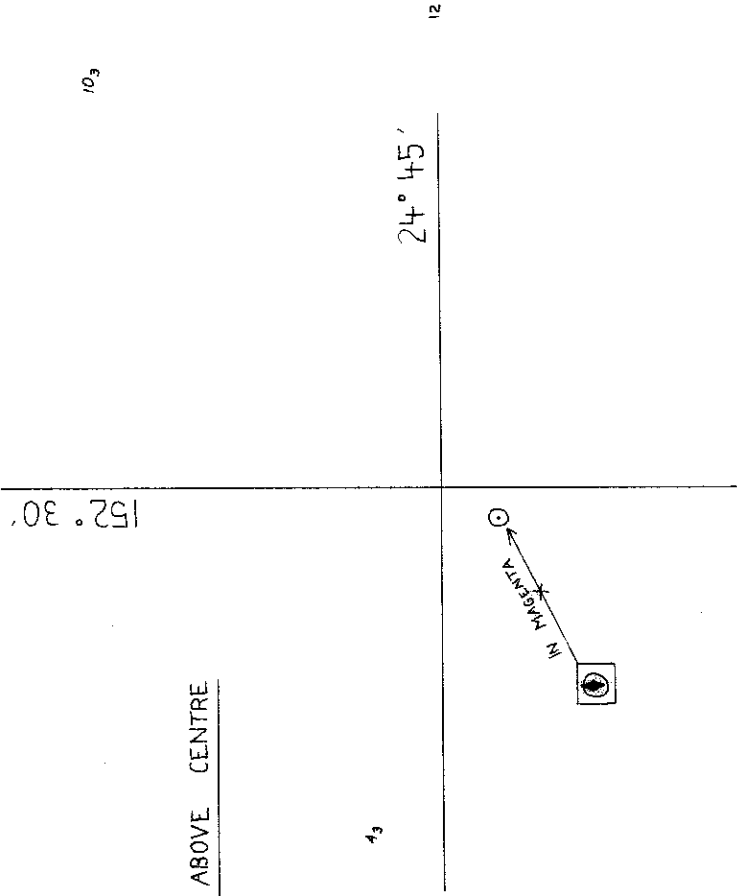

236 / 2002

269 / 2002

© Commonwealth of Australia 2002

AUS 817

F7

126

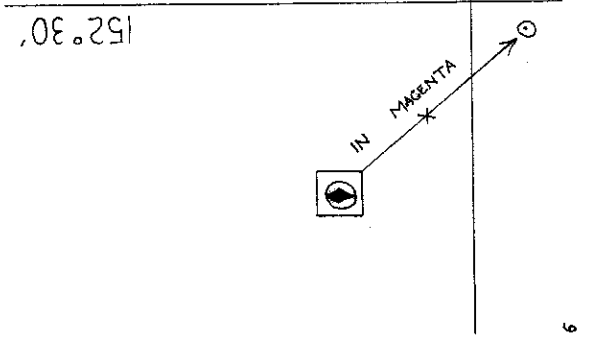

566 / 2001

269 / 2002

© Commonwealth of Australia 2002

AUS 818

F7

BELOW CENTRE

LEFT BELOW CENTRE

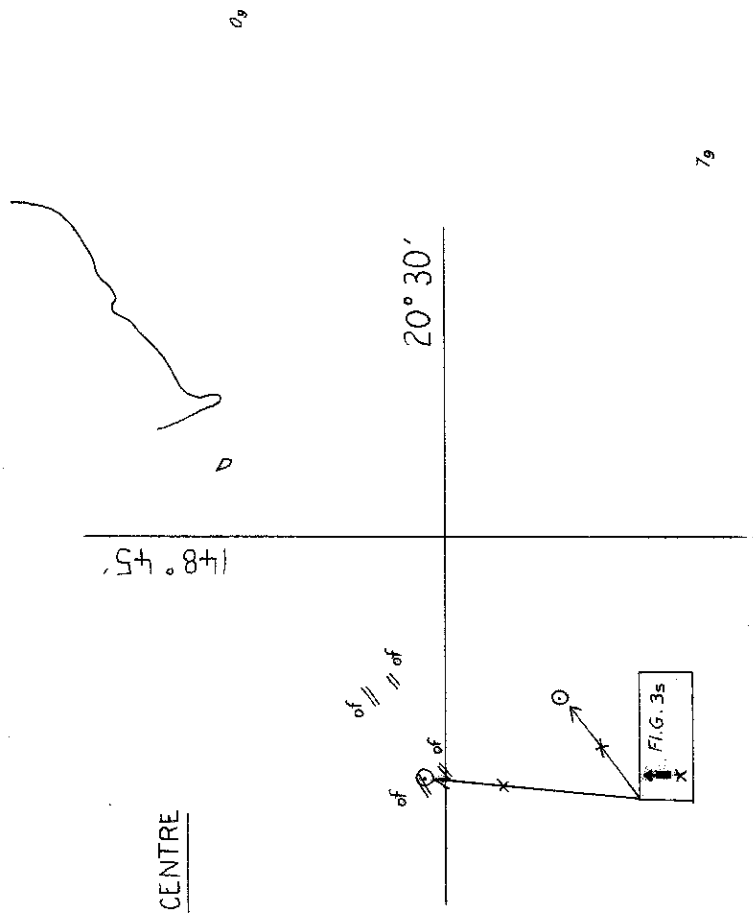

192 / 2002

271 / 2002

© Commonwealth of Australia 2002

F8

AUS 252

102

ABOVE CENTRE

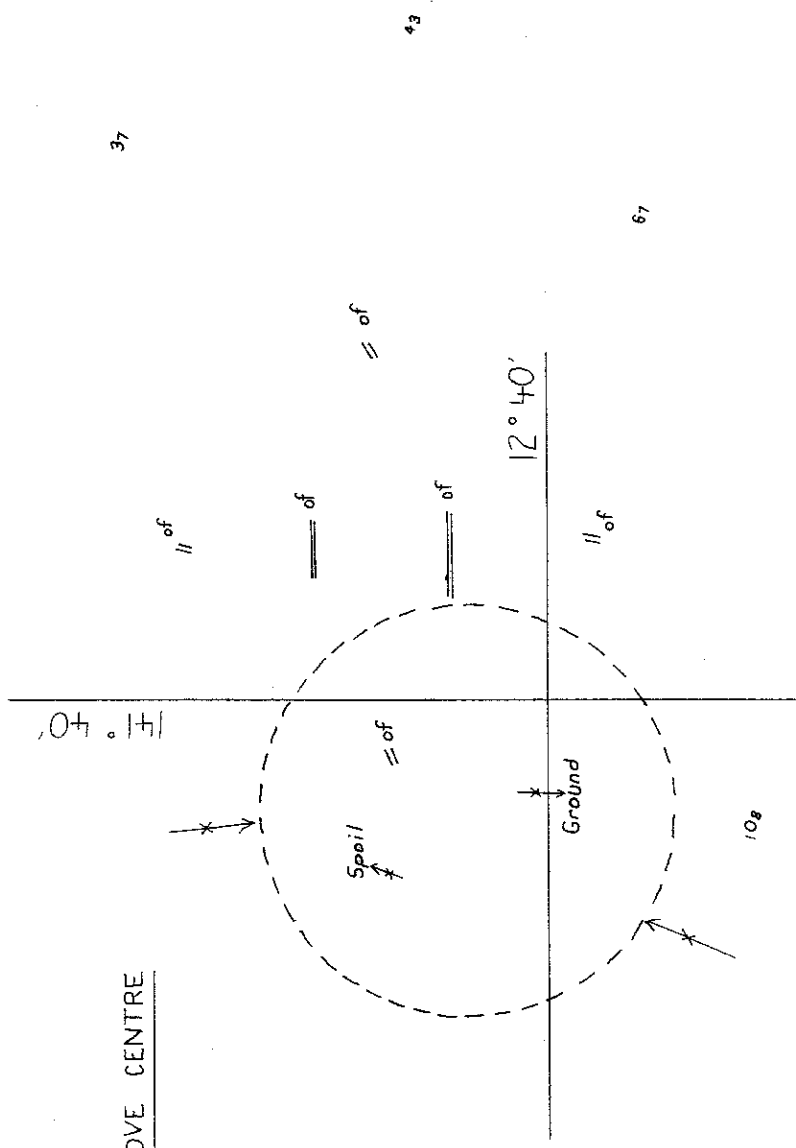

663 / 2001

272 / 2002

© Commonwealth of Australia 2002

F8

AUS 4

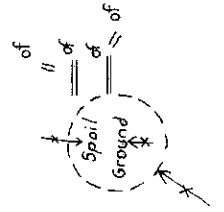
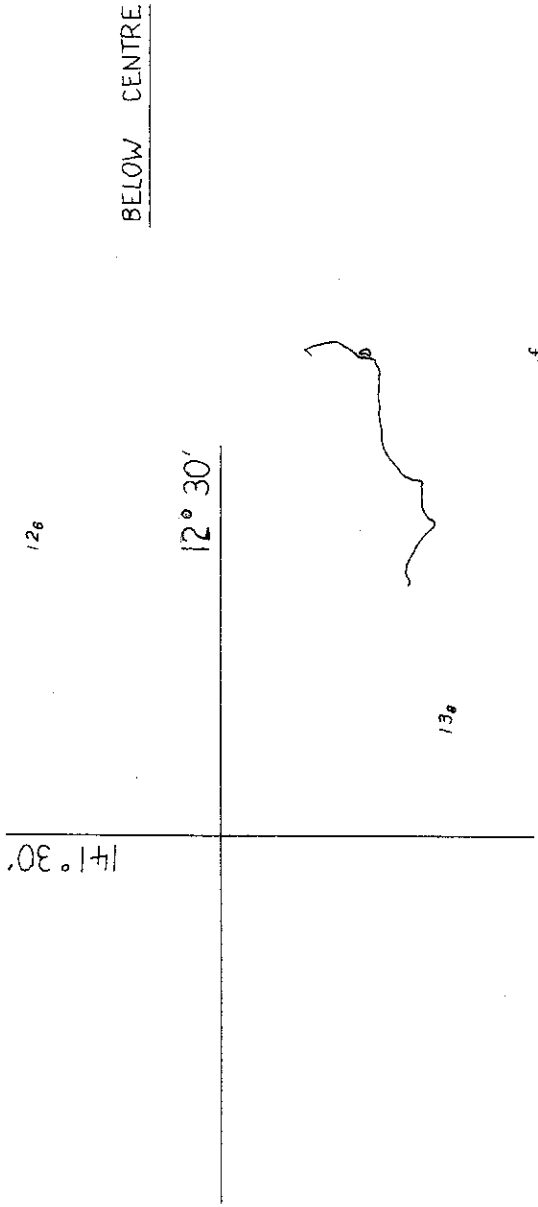

32

F8

621 / 2001

272 / 2002

© Commonwealth of Australia 2002

AUS 301

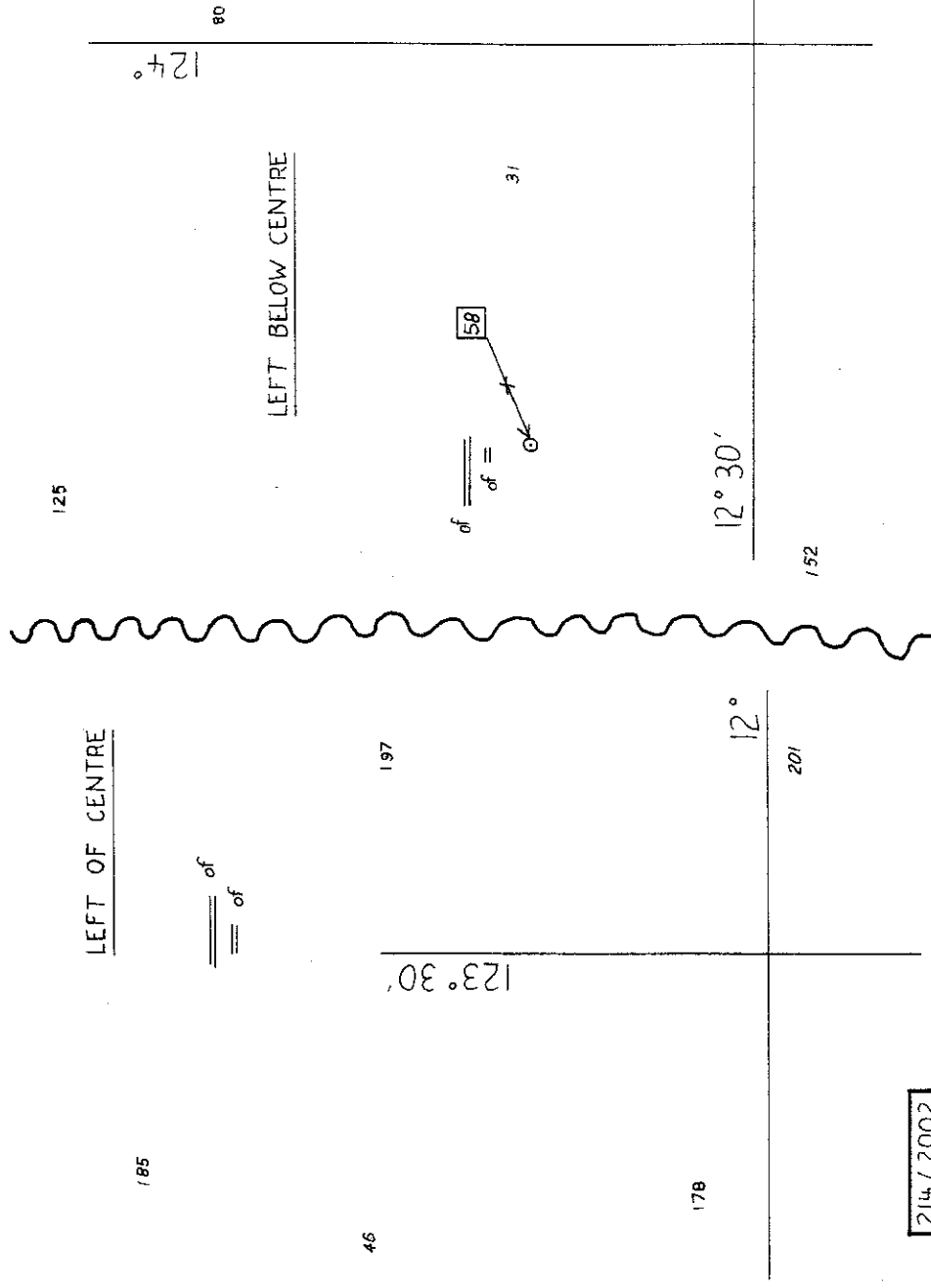

185

LEFT OF CENTRE

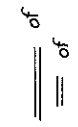

46

197

123° 30'

178

12°

201

152

12° 30'

90

95

214 / 2002

273,274 / 2002

© Commonwealth of Australia 2002

F2

AUS 314

LEFT ABOVE CENTRE

120

17

of  
of

12°

115

50

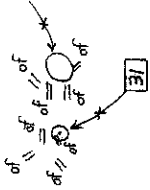

273

563 / 2001

92

F1

273, 274, 2002

© Commonwealth of Australia 2002

AUS 413

10°



256

510

125°

LEFT ABOVE CENTRE



165

LEFT OF CENTRE

of  
of

13

1461

4040

669

12

5°

130°

5°

3330

2739

F1

569 / 2001

INT 603

273, 275, 276 / 2002

© Commonwealth of Australia 2002

AUS 4603

LEFT ABOVE CENTRE

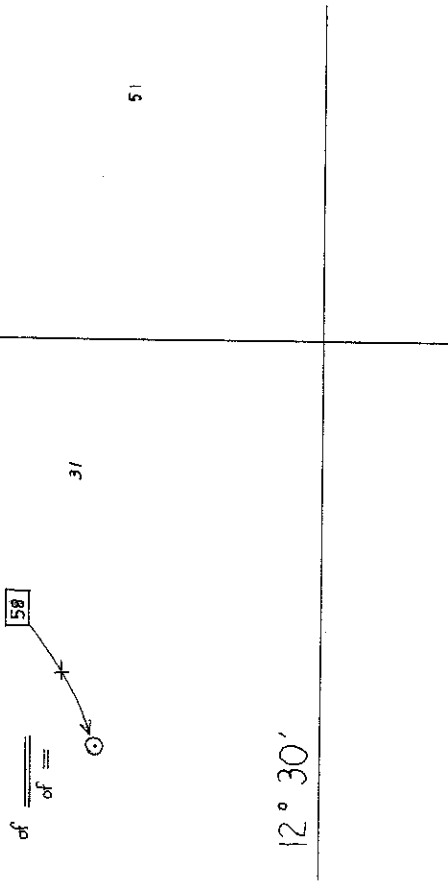

92

58

31

51

12° 30'

188

154

214 / 2002

194

274 / 2002

© Commonwealth of Australia 2002

AUS 319

165

LEFT ABOVE CENTRE

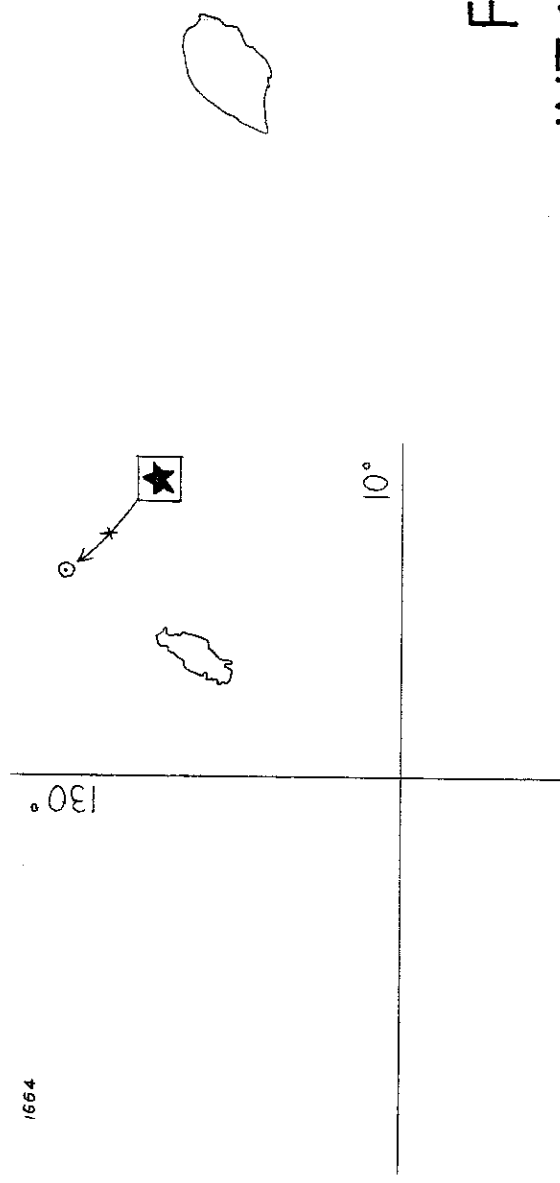

1664

10°

1260

200 / 2002

275 / 2002

© Commonwealth of Australia 2002

F1

INT 60

AUS 4060

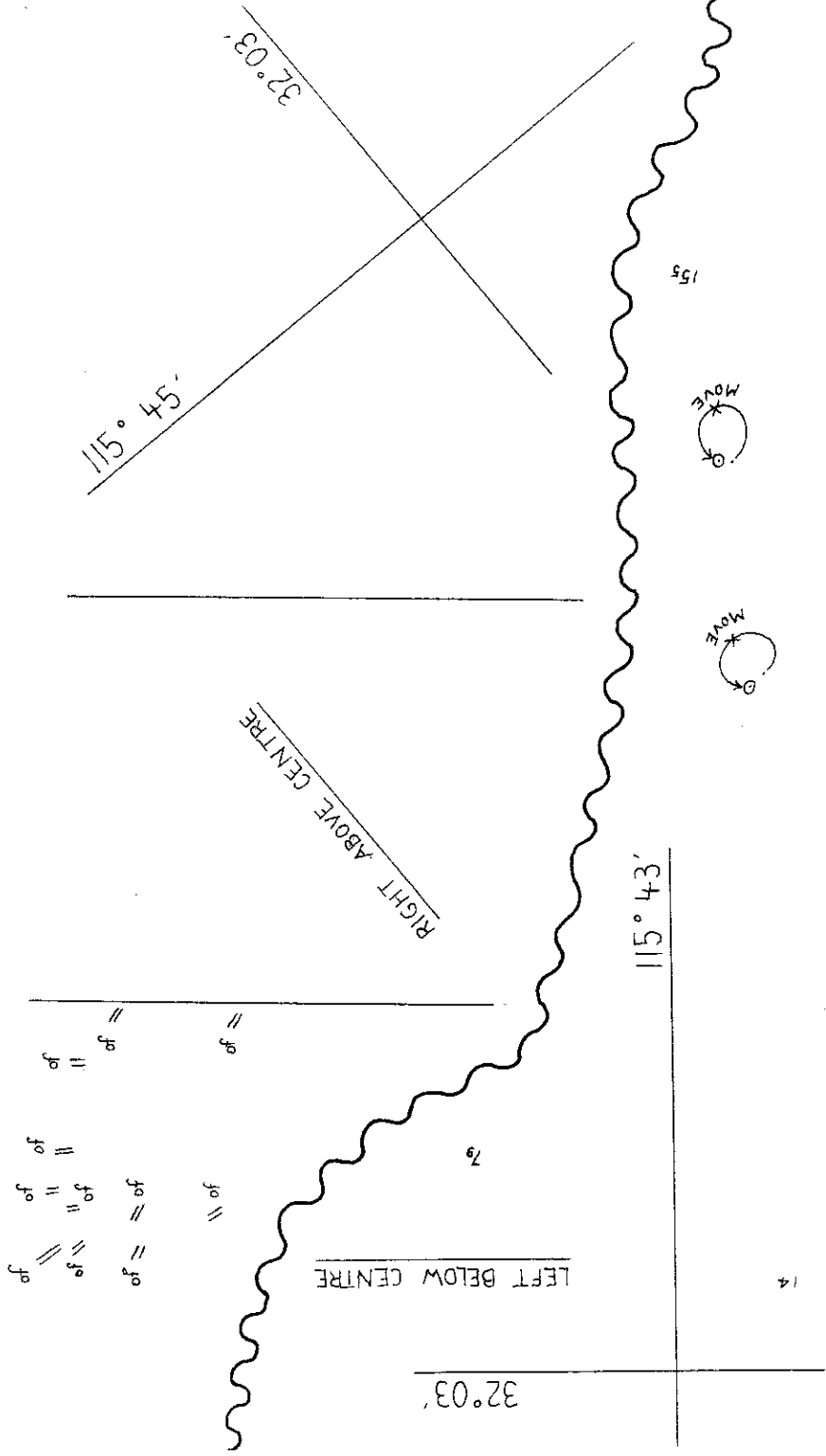

[33 / 2002]

F4

277,278/2002

© Commonwealth of Australia 2002

AUS 113

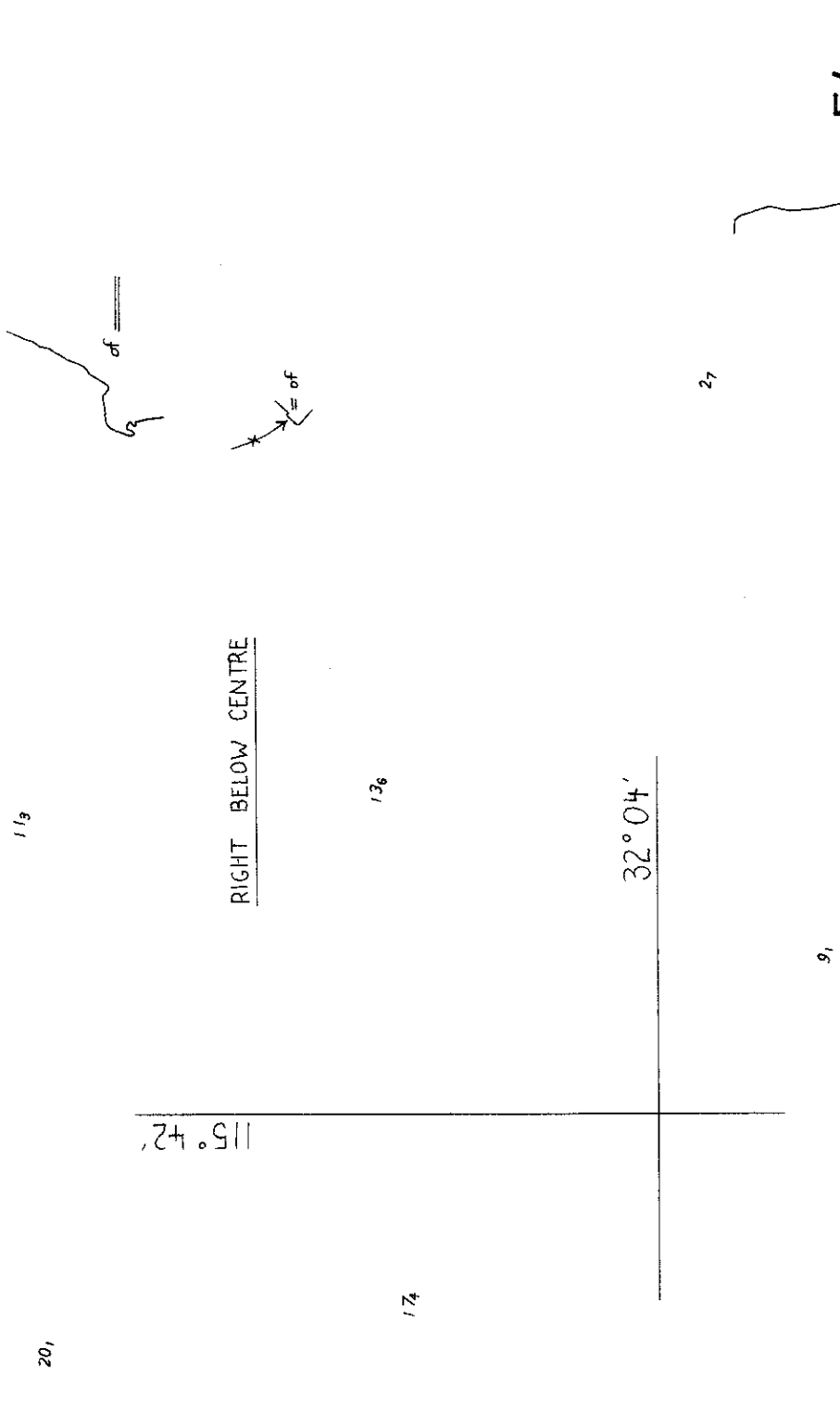

[708 / 2001]

14

F4

278/2002

© Commonwealth of Australia 2002

AUS 112





RIGHT BELOW CENTRE

7

2

17

12

35°

195 / 2002

9

14

20

F1

281/2002

© Commonwealth of Australia 2002

AUS444

34° 30'

23

RIGHT BELOW CENTRE

24

52

38

of

75

F1(2) 10.5 29ft 10M

240 / 2002

F5

281/2002

© Commonwealth of Australia 2002

AUS781

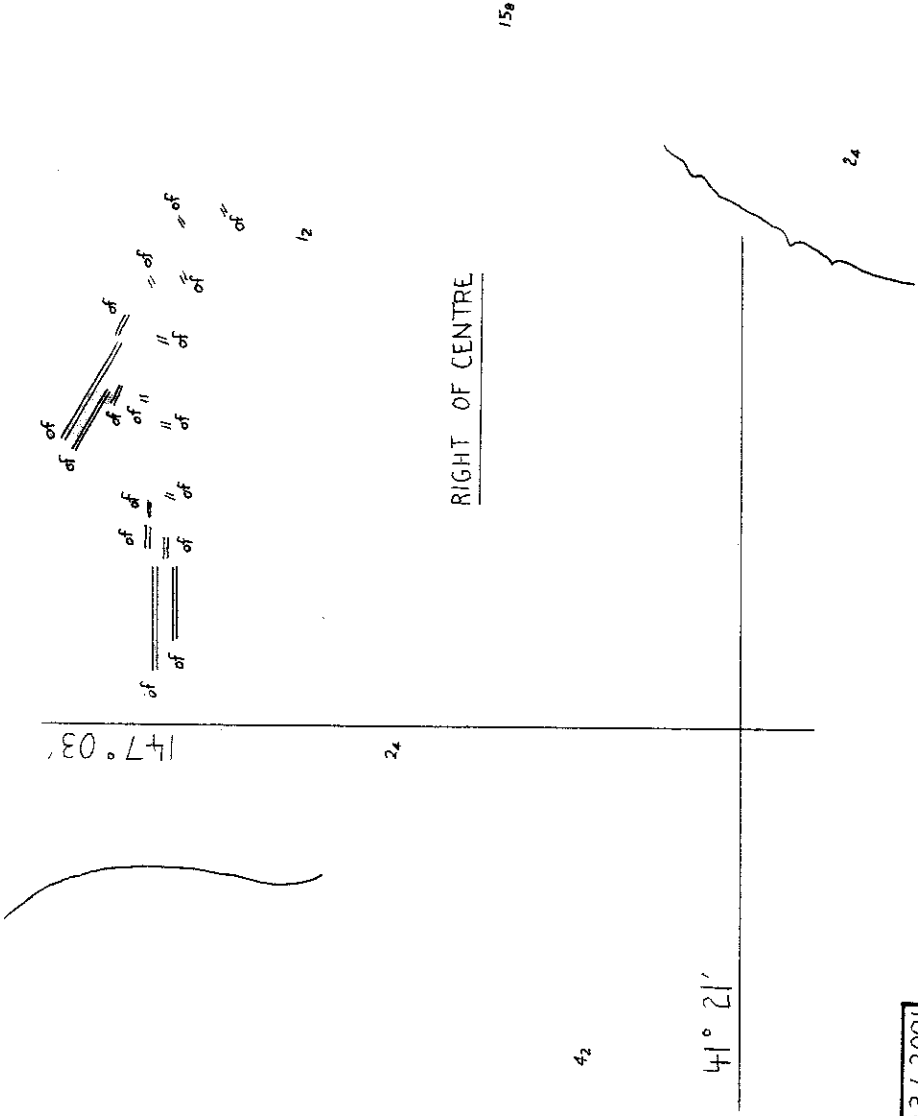

[643 / 2001]

282/2002

© Commonwealth of Australia 2002

F6  
AUS 168

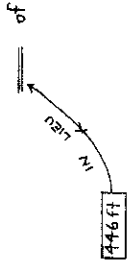

36

LEFT BELOW CENTRE

33

147°

32

[199 / 2002]

283/2002

© Commonwealth of Australia 2002

F6

AUS 357

33

58

55

60

RIGHT OF CENTRE

136m

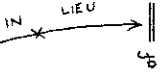

47



58

58

55

39° 15'

60

58

58

457 / 2001

2831/2002

© Commonwealth of Australia 2002

AUS 802